

**IDENTIFICATIVI SERRATURA**

**INGRESSO CHIAVE mm. 63**      **PASSO CHIAVISTELLI mm. 25**

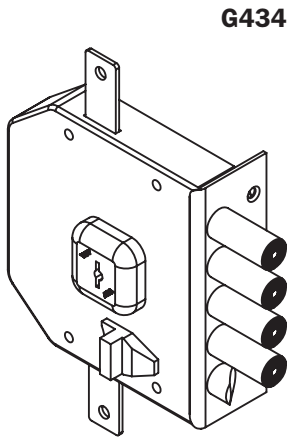

**G434**

CODICE	MANO	
	DX	SX
G434DX	•	
G434SX		•

**CODIFICA**

**VARIANTI**

**G431**

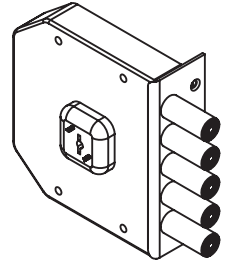

**G432**

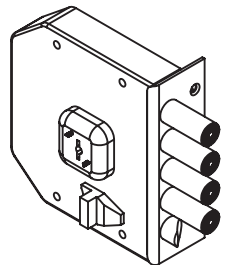

**DISEGNO TECNICO**

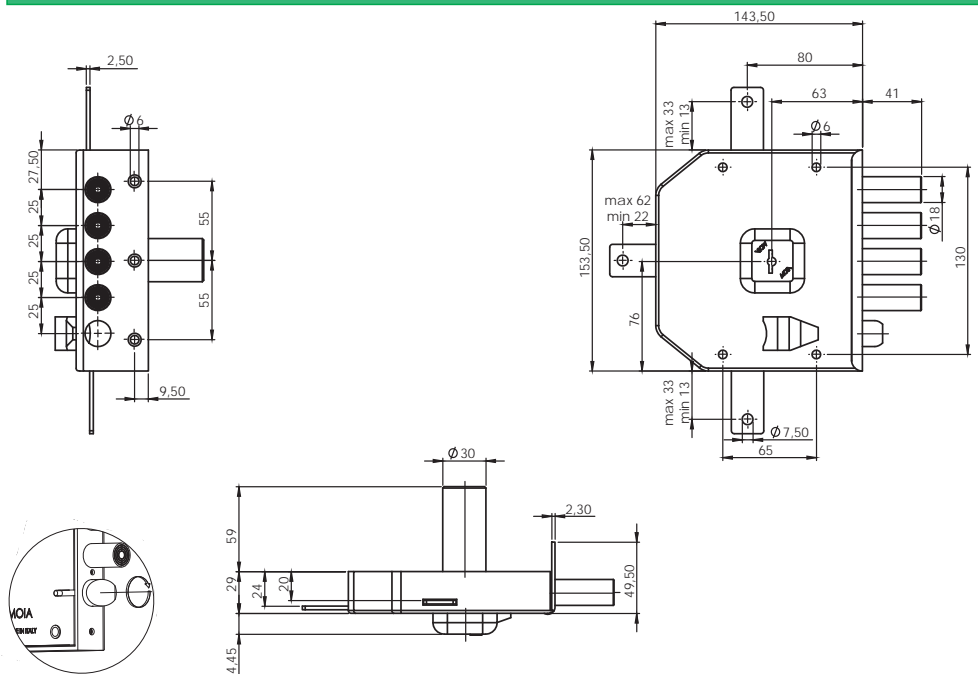

**G433**

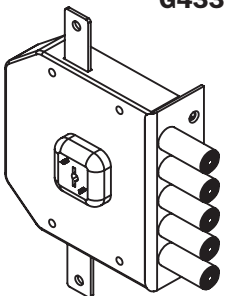

**G435**

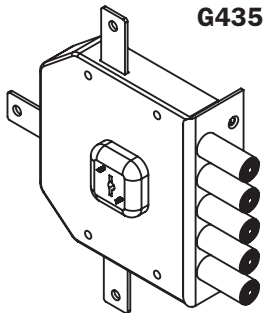

**G436**

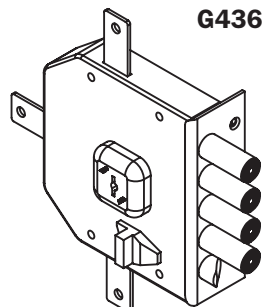

**reversibile**

<b>IMBALLO</b>			<b>OPTIONAL</b>					
							<b>KA</b>	

Applicare Pompa