



fumasi[®]
PROFESSIONAL TOOLS
by Gimap

UTENSILI FORTI PER LAVORI DURI

TOUGH TOOLS FOR TOUGH JOBS



**CATALOGO
GENERALE**

NUMERO 8

www.fumasi.it



TRADIZIONE **ESPERIENZA** **INNOVAZIONE**

TRADITION, EXPERIENCE, INNOVATION

La storia della Gimap inizia 75 anni fa nell'immediato dopoguerra, quando Mario Gianola, esperto artigiano cresciuto nella cultura di Premana, storicamente famosa per la produzione di utensili professionali per il taglio, apre in proprio una piccola officina per la progettazione e produzione di varie tipologie di forbici. Il forte desiderio di fare e sviluppare nuove attività, tipiche di quegli anni e la visione imprenditoriale di Mario Gianola, creano le basi per un progressivo sviluppo tecnico e aziendale della Gimap.

The history of Gimap starts 75 years ago at the end of the war, when Mario Gianola, expert artisan born in the culture of Premana, historically famous for the production of professional cutting tools, starts up an activity to project and produce a wide range of professional scissors. The wish to develop new activities of those years and the entrepreneur attitude of Mario Gianola are the basis of a progressive technical and company growth of Gimap company.



**THE VALUE OF TRADITION
AND FOR THE CULTURE
IT IS NOT THE WORSHIP
BUT IS OUR CONTINUITY
TO KEEP ALWAYS
AND PASSION OF THOSE**

**ON FOR OUR COMPANY
TURE OF PREMANA
HIP OF PAST RESULTS
UOUS COMMITMENT
S ALIVE THE FIRE
E WHO PREVIOUSSED US**

”

VOGLIA DI CRESCERE

WILL TO GROW

La Gimap, grazie ad un processo di costante crescita tecnica e produttiva sotto la spinta imprenditoriale dei figli del fondatore, Biagio e Vittorino, oggi affiancati anche dalla terza generazione composta da Enrico, Alan, Mario, Antonio e Monica, nel 2004 ha assunto una importante decisione acquistando il marchio Fumasi, già noto e apprezzato per qualità e innovazione a livello internazionale, accelerando così il proprio sviluppo aziendale, tecnico e commerciale in Italia e all'Estero.

Il gruppo Gimap oggi comprende anche la RBB, che offre una gamma completa di strumenti e accessori per i settori cosmetico e mercerie e la Henbor, specializzata nella produzione di strumenti professionali per il settore parrucchieri, consolidando così la propria immagine di affidabilità, competitività a garanzia di continuità imprenditoriale della propria clientela nei settori professionali **meccanico, termoidraulico, elettrico, giardinaggio, bricolage, cosmetico e tessile.**

Thanks to constant technical and productive growth together with founder's sons Biagio and Vittorino's business boost, and same through several years by their children, Enrico, Alan, Mario, Antonio and Monica, representing the third family generation, in 2004 Gimap acquired the Fumasi brand appreciated for its quality and innovation, widening in this way technical and commercial position in Italy and on international basis. Gimap group today includes also Henbor Co. specialized in professional instruments for hair care and RBB CO. specialized in cosmetics and textile professional sectors. Gimap group has now a solid image as reliable partner for quality, competitiveness and guaranty of entrepreneurial future continuity for their customers in mechanical, electrician, thermo-hydraulic, gardening, DIY, cosmetic and textile sectors.

SETTORE MECCANICO
MECHANICAL



SETTORE IDRAULICO
HYDRAULIC



SETTORE ELETTRICO
ELECTRIC



SETTORE EDILE
CONSTRUCTION



GIARDINAGGIO
GARDENING



SETTORE TESSILE / CASALINGO
TEXTILE / HOUSEHOLD



GIMAP[®]
Lame dal 1950

fumasi[®]
Since 1935
PROFESSIONAL TOOLS
by gimap

rbb
MADE IN ITALY
by gimap

HENBOR[®]
Superior

Un altro punto di forza Gimap-Fumasi sui mercati di tutto il mondo, è la possibilità di produrre elevati quantitativi in pochissimo tempo. Il magazzino sempre ben fornito, permette di evadere gli ordini quasi in tempo reale con la massima efficienza ed affidabilità. Inoltre, il sistema di gestione e di qualità è conforme ai requisiti del certificato ISO 9001:2008

Another Gimap-Fumasi's strengths on the worldwide market is the ability to produce large quantities in a very short time. The well-stocked warehouse allows to process orders almost in real time with maximum efficiency and reliability. In addition, the management and quality system complies with the requirements of the ISO 9001:2008 certificate.



RICERCA E INNOVAZIONE

RESEARCH & INNOVATION

Il costante e progressivo potenziamento delle strutture produttive del gruppo Gimap Fumasi si è attuato grazie ad una costante ricerca ed adozione di materiali avanzati come l'acciaio al carbonio C50, C60 e l'acciaio inox AISI 420, dei trattamenti termici più innovativi e dei macchinari di ultima generazione a controllo numerico secondo le normative industria 4.0. Inoltre il gruppo Gimap Fumasi ha investito costantemente nella ricerca delle soluzioni ergonomiche più efficienti per la ottimizzazione dell'uso degli utensili sia per prestazioni che per confort d'uso

The development of the Gimap -Fumasi group's technical structures is due to a constant research of advanced materials as carbon C50, C60 steel and INOX AISI 420 steel. Furthermore innovative thermic treatments and last generation machineries with numeric control in line with 4.0 industry regulation were adopted. Gimap- Fumasi Center of Research has constantly invested into the identification of the more advanced ergonomic solutions able to give better and more comfortable use conditions to the professional users.

LINEA PRO

PRO TOOLS

Le gamme di tutte le linee di prodotti del gruppo Gimap Fumasi comprendono prodotti di vari livelli qualitativi e prestazionali per la migliore individuazione del prodotto ideale per il cliente.

In particolare nella gamma Fumasi i prodotti "top di gamma" sono contraddistinti da un marchio PRO per la più agevole e corretta identificazione del prodotto più idoneo alle specifiche esigenze operative.

All the Gimap Fumasi group's product ranges offer differentiated quality characteristics in order to allow the ideal items selection. Fumasi range, in particular, offers the "top of the range" items identifying them with a PRO sign in order to support our customers selection of the ideal items for the specific more demanding performances.

ALTE PERFORMANCE, COMODITA' E PRATICITA', DATE DALLA QUALITA' DEI MATERIALI IMPIEGATI E DALLE CARATTERISTICHE TECNICHE E FUNZIONALI DELL'ARTICOLO IN GAMMA.

THE PARTICULAR STRUCTURE GIVEN BY THE QUALITY OF THE MATERIAL USED AND THE TECHNICAL FEATURES, CREATED AN HIGH PERFORMANCE AND CONFORT USE FOR ALL THE ARTICLES INCLUDED IN THE RANGE



I Clienti del gruppo Gimap Fumasi possono costantemente contare sui funzionari tecnici e commerciali del gruppo per qualsiasi supporto ed esigenza mirate alla loro massima efficienza operativa per realizzare INSIEME risultati di reciproca soddisfazione.

The Gimap Fumasi customers can constantly count on technical and commercial company staff for any support or need aimed at the best operative efficiency to achieve mutually satisfying results TOGETHER.

DOVE TROVARCI

WHERE TO FIND US

Premana (LC) , borgo medioevale di 2200 abitanti a 1000 metri slm, dove si custodisce una cultura pluri-centenaria per la produzione di utensili e attrezzi da taglio per impiego professionale e domestico, frutto di una tradizione che si rinnova da secoli, di generazione in generazione, e che costituiscono tutt'oggi uno dei primati italiani dell'industria e dell'artigianato del mondo.

"CAPITALE DELLE LAME" così, venne considerata anticamente con la produzione di spade taglienti e, dagli inizi del secolo, di coltelli affilati, forbici per tutti gli usi ed altri utensili professionali.

Premana (LC), a medieval village of 2200 inhabitants at 1000 meters above sea level, where a centuries-old culture of the production of cutting tools for professional and domestic uses is still preserved, the result of a tradition that has been renewed for centuries, from generation to generation, and which still constitutes one of the best Italian industry and craftsmanship in the world.

"CAPITAL OF THE BLADES" thus, was considered in ancient times with the production of sharp swords and, from the beginning of the century, of sharp knives, scissors for all uses and other professional tools.

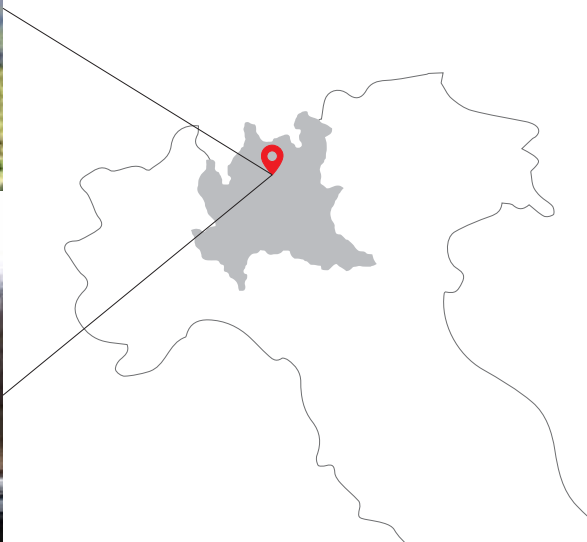

DA LECCO

Seguire strada per Valsassina SP62 fino a Taceno.
Seguire quindi SP67 direzione Premana.

DA MILANO

Seguire SS36 Monza-Lecco in direzione Lecco.
(vedi DA LECCO)

DA BERGAMO

Seguire SS342 fino a Cisano Bergamasco
quindi continuare sulla SS639 in direzione Lecco.
(vedi DA LECCO)

DA COMO

Seguire SS342 in direzione Erba
proseguire fino a Lecco.
(vedi DA LECCO)

FROM LECCO

Follow the road for Valsassina SP62 up to Taceno.
Then follow SP67 towards Premana.

FROM MILAN

Follow SS36 Monza-Lecco towards Lecco.
(see FROM LECCO)

FROM BERGAMO

Follow SS342 up to Cisano Bergamasco
then continue on the SS639 towards Lecco.
(see FROM LECCO)

FROM COMO

Follow SS342 towards Erba
continue to Lecco.
(see FROM LECCO)

Forbici per elettricisti <i>Electrician's scissors</i>	12
Cesoie taglialamiera <i>Sheet metal shears</i>	21
Cesoie multiuso <i>Multi-purpose shears</i>	26
Forbici multiuso <i>Multipurpose scissors</i>	34
Utensili da taglio <i>Cutting tools</i>	37
Giraviti universali <i>Universal screwdrivers</i>	43
Giraviti 1000 VOLT <i>Screwdrivers 1000 VOLT</i>	50
Pinze universali <i>Universal pliers</i>	54
Sezione 1000 VOLT <i>1000 VOLT section</i>	58
Pinze di precisione <i>Precision pliers</i>	65
Pinze regolabili <i>Adjustable pliers</i>	69
Pinze rivettatrici <i>Riveting pliers</i>	73
Tenaglie <i>Pincers</i>	77
Pinze per fili e cavi <i>Pliers for wires and cables</i>	80
Pinze per crimpare <i>Crimping pliers</i>	84
Saldatori e articoli per cablaggio <i>Soldering irons and wiring tools</i>	93
Set di utensili da elettricista <i>Electrician tools set</i>	97
Chiavi universali <i>Universal keys</i>	102
Chiavi maschio <i>Male keys</i>	112
Chiavi a "T" <i>"T" Keys</i>	117
Chiavi a tubo <i>Pipe wrenches</i>	122
Chiavi a bussola <i>Socket wrenches</i>	126
Chiavi 1000 volt <i>1000 volts keys</i>	131
Accessori da 1/4"-3/8"-1/2"-3/4"-1" <i>1/4"-3/8"-1/2"-3/4"-1" Accessories</i>	134
Accessori 1000 volt <i>1000 volt accessories</i>	154
Set inserti e bussole <i>Insert and socket set</i>	156
Giratubi e pinze per tubi <i>Pipe wrenches and pipe pliers</i>	161
Taglio e preparazione tubi <i>Pipe cutting and preparation</i>	166
Curvatura e saldatura tubi <i>Pipe bending and welding</i>	177
Manutenzione e riparazione tubi <i>Pipe maintenance and repair</i>	185
Set di utensili per idraulici <i>Set of tools for plumbers</i>	194

FORBICI E CESCOIE SCISSORS AND SHEARS

01

GIRAVITI SCREWDRIVERS

02

PINZE E TENAGLIE PLIERS AND PINCES

03

SETTORE ELETTRICO ELECTRIC

04

CHIAVI DI MANOVRA OPERATING KEYS

05

STRUMENTI OPERATIVI E ACCESSORI OPERATING INSTRUMENTS AND ACCESSORIES

06

SETTORE IDRAULICO HYDRAULIC

07

Martelli e mazzette <i>Hammers and mallets</i>	197
Scalpellini <i>Chisels</i>	203
Allestimento cantiere <i>Construction site preparation</i>	211
Impermeabilizzazione <i>Waterproofing</i>	219
Accessori per la copertura <i>Cover accessories</i>	224
Utensili per misurare <i>Measuring tools</i>	235
Livelle <i>Levels</i>	244
Foratura <i>Drilling</i>	248
Taglio e levigatura <i>Cutting and sanding</i>	264
Tasselli in nylon <i>Nylon dowels</i>	271
Tasselli leggeri prolungati <i>Extended light blocks</i>	277
Tasselli in acciaio <i>Steel dowels</i>	280
Tasselli per idrotermosanitaria <i>Plugs for plumbing</i>	282
Portautensili pratici <i>Practical tool holders</i>	288
Carrelli portautensili <i>Tool trolleys</i>	299
Soluzioni espositive <i>Display solutions</i>	304
Cesoie da potatura <i>Pruning shears</i>	308
Lavorazione del legno <i>Wood processing</i>	320
Cura del prato <i>Lawn care</i>	330
Cura del terreno <i>Ground care</i>	335
Manici in faggio <i>Beech handles</i>	343
Potatura professionale <i>Professional pruning</i>	346
Accessori per orto e giardino <i>Accessories for vegetable garden and garden</i>	354
Lame per ricambi <i>Spare parts blades</i>	361
Merceria <i>Haberdashery</i>	364
Forbici cucina <i>Kitchen scissors</i>	376
Manicure e pedicure <i>Manicure & pedicure</i>	380
Cartelle espositive <i>Exhibition folders</i>	384

MARTELLERIA HAMMERING

08

SETTORE EDILE CONSTRUCTION

09

STRUMENTI DI MISURA MEASUREMENT TOOLS

10

UTENSILI ROTANTI ROTATING TOOLS

11

FISSAGGIO FIXING

12

CONTENITORI PER ATTREZZI TOOLS BOX

13

GIARDINAGGIO GARDENING

14

FORBICI SCISSORS

15

ALTA RESISTENZA ED AFFIDABILITA'

HIGH RESISTENCE & RELIABILITY



LINEA PRO
PRO LINE



ISOLATO PER TENSIONE 1000V
INSULATED FOR 1000V VOLTAGE



CONFORME ALLE NORME DVE
COMPLIES WITH DVE STANDARDS

12 Forbici per elettricisti
Electrician's scissors

19 Forbici telefonista
telephone operator scissors

Forbici per elettricisti

Electrician's scissors

230847 TECNOLOGIA E INNOVAZIONE **PATENTED**
 TECHNOLOGY AND INNOVATION



LA PIU' INNOVATIVA FORBICE PROFESSIONALE PER ELETTRICISTI NATA NEL CENTRO DI RICERCHE FUMASI
 THE MOST INNOVATIVE PROFESSIONAL SCISSORS FOR ELECTRICIANS BORN IN THE FUMASI RESEARCH CENTER

1



Funzione spelafili
 Stripping function

2



Zigrinatura
 antiscivolo
 Non-slip knurling

3



Design innovativo
 dell'impugnatura
 Innovative design
 of the handle



FORBICI PROFESSIONALI PER ELETTRICISTI

PROFESSIONAL ELECTRICIAN'S SCISSORS

- ♦ Interamente costruita in acciaio INOX AISI 420 particolarmente resistente e di lunga durata
Entirely built in AISI 420 stainless steel particularly durable and long lasting
- ♦ Soluzioni ergonomiche e dimensionali dei manici, frutto di accurate ricerche con gli utilizzatori più esigenti
Ergonomic and dimensional solutions of the handles, the result of accurate research with the most demanding users
- ♦ Qualità e copertura del perno di giunzione di massima affidabilità e sicurezza, con bullone regolabile a proprio piacere
Reliable quality and coverage of the connecting pin and safety, with bolt adjustable to your liking
- ♦ Trattamenti termici specificamente idonei alle esigenze di massima efficienza e durata negli impieghi più stressanti
Heat treatments specifically suited to the needs of maximum efficiency and duration in the most stressful uses
- ♦ Lame con durezza 58 HRC con tacca taglia / spella cavi per la massima efficienza di taglio dei conduttori
Blades with hardness 58 HRC with notch cuts / strips cables for the maximum cutting efficiency of conductors
- ♦ Per favorire le operazioni di taglio dei conduttori è stata realizzata una apposita sagoma a gola tagliente su entrambe le lame
To facilitate the cutting operations of the conductors, it was created a special shape with a cutting throat on both blades

Frutto del costante impegno nel dedicare risorse sia interne nel Centro Studi Tecnici che esterne, monitorando l'evoluzione delle richieste degli utilizzatori più esigenti, Fumasi, ha sviluppato un progetto altamente professionale per qualità, prestazioni e soluzioni ergonomiche innovative; essa infatti conferma e rafforza ulteriormente il primato tecnico a livello internazionale nello studio e realizzazione di strumenti professionali da taglio.

As a result of the constant commitment in dedicating constant resources both internally in the Technical Study Center and externally, monitoring the evolution of the needs of the most demanding users, Fumasi has developed a highly professional project for quality, performance and innovative ergonomic solutions; in fact it confirms and further strengthens the technical leadership at an international level in the study and production of professional cutting tools.

Brevetto di utilità Fumasi: In attesa di brevetto
 Fumasi utility patent: Patent pending

Codice	mm	gr		Barcode
230847	192	150	12	8033183846242

230846 FORBICI PER ELETTRICISTI CON TAGLIACAVO ELECTRICIAN'S SCISSORS WITH CABLE CUTTER



- Lame in acciaio al cromo vanadio con durezza 58 - 60 HRC
Chrome vanadium steel blades with hardness 58 - 60 HRC
- Manici ergonomici in nylon + 30% fibra di vetro
Ergonomic handles in nylon + 30% glass fiber
- Copertura del perno per una maggiore sicurezza
Cover pivot for added safety
- Funzione per crimpare terminali 0,5 - 4 mm **1**
Crimping function for terminals of 0.5 - 4 mm
- Tacca taglia/ spella cavi su entrambe le lame per cavi da 50 mm²
Notch cuts / strips cables on both blades for 50 mm² cables
- Tacca per pulire scatole elettriche **2**
Notch for cleaning electrical boxes

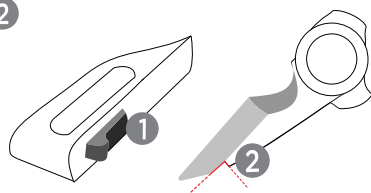

Codice	Pezzi / Pieces	mm	gr		Barcode
230846		145	82	12	8033183556905
230846P	Con portaforbice / With scissors holder			12	8033183556653
238046	24 Espositore / Exhibitor art. 230846			1	8033183556776



230845 FORBICI PER ELETTRICISTI CON TAGLIACAVO ELECTRICIAN'S SCISSORS WITH CABLE CUTTER

PATENTED



- Lame in acciaio al cromo vanadio con durezza 58 - 60 HRC
Chrome vanadium steel blades with hardness 58 - 60 HRC
- Manici ergonomici in nylon + 30% fibra di vetro
Ergonomic handles in nylon + 30% glass fiber
- Bullone M6 ad alta resistenza
High-resistant M6 bolt
- Tacca taglia/ spella cavi sulla lama per cavi da 50 mm²
Notch cuts / strips cables on the blade for 50 mm² cables

Brevetto di utilità Fumasi: **PAT. 0000265245**
Brevet d'utilité Fumasi: **PAT. 0000265245**

Codice	Pezzi / Pieces	mm	gr		Barcode
230845		145	82	12	8033116539609
230845P	Con portaforbice / With scissors holder			12	8033183559562
238045	24 Espositore / Exhibitor art. 230845			1	8033116539739



230845K FORBICI ELETTRICISTA PER KEVLAR ELECTRICIAN'S SCISSORS FOR KEVLAR

Progettate per impieghi gravosi con lame spesse per resistere alla flessione
Designed for heavy duty with thick blades to resist bending



- Lame in acciaio temperato per il taglio di Kevlar e fibra di vetro
Tempered steel blades for Kevlar and fiber glass cutting
- Tacca taglia / spella cavo sulla lama per lavori rapidi
Cut / split cable notch on the blade for quick work
- Manici ergonomici in nylon + 30% fibra di vetro
Nylon + 30% glassfiber ergonomic handle

Codice	mm	gr		Barcode
230845K	145	82	12	8033183567154



230849 FORBICI PER ELETTRICISTI 1000V
1000V ELECTRICIAN'S SCISSORS

- Lame dritte microdentate in acciaio INOX
Stainless steel micro-toothed straight blades
- Impugnatura a forte spessore rivestita in materiale bicomponente con estremità aggiuntive sugli anelli per una presa più sicura.
Bi-component and thick handle with additional ends on the rings for a more secure grip.
- Funzione tagliacavo sulla lama
Cable cutting function on the blade
- Completa di paramano per garantire la massima sicurezza durante l'utilizzo
With handguard to ensure maximum safety during use



Codice	mm	gr	📦	Barcode
230849	160	121	12	8033183562111

230841 FORBICI PER ELETTRICISTI
ELECTRICIAN'S SCISSORS

- Lame dritte microdentate in acciaio INOX
Stainless steel micro-toothed straight blades
- Manici in ABS
ABS handle



Codice	Pezzi / Pieces	mm	gr	📦	Barcode
230841		140	84	12	8033183569110
230841P	Con portafortbice / With scissors holder			12	8033183843029
238041	24	Espositore / Exhibitor art. 230841		1	8033183569196

230842 FORBICI PER ELETTRICISTI
ELECTRICIAN'S SCISSORS

- Lame dritte microdentate in acciaio INOX
Stainless steel micro-toothed straight blades
- Manici antiscivolo in bicomponente bicolore
Bi-component bi-tone non-slip handle



Codice	Pezzi / Pieces	mm	gr	📦	Barcode
230842		140	84	12	8033183568359
230842P	Con portafortbice / With scissors holder			12	8033183594334
238042	24	Espositore / Exhibitor art. 230842		1	8033183569202

230842T FORBICI PER ELETTRICISTI CON TAGLIACAVO
ELECTRICIAN'S SCISSORS WITH CABLE CUTTER

- Lame microdentate in acciaio INOX
Stainless steel micro-toothed blades
- Manici antiscivolo in bicomponente bicolore
Bi-component bi-tone non-slip handle
- Funzione tagliacavo sulla lama
Cable cutting function on the blade



Codice	mm	gr	📦	Barcode
230842T	140	84	12	8033183840295
230842TC	Con portafortbice / With scissors holder		12	8033183843036

230833 FORBICI PER ELETTRICISTI CON TAGLIACAVO ELECTRICIAN'S SCISSORS WITH CABLE CUTTER

- ♦ **Lame microdentate in acciaio INOX**
Stainless steel micro-toothed blades
- ♦ **Manici antiscivolo in bicomponente bicolore con rivestimento in gomma termoplastica delle parti soggette ad usura che garantisce un elevato comfort nell'utilizzo prolungato**
Bi-component non-slip handles with two-tone coating thermoplastic rubber of the parts subject to wear that guarantees high comfort in prolonged use
- ♦ **Perno con bullone regolabile**
Pin with adjustable bolt
- ♦ **Funzione tagliacavo su entrambe le lame** ①
Cable cutting function on the blade

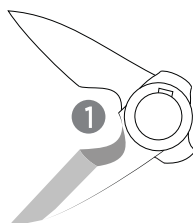

Codice	Pezzi / Pieces	mm	gr		Barcode
230833		160	80	12	8033183560056
230833P	Con portafortice / With scissors holder			12	8033183586261
238033	24 Espositore / Exhibitor art. 230833			1	8033183561206



230834 FORBICI PER ELETTRICISTI ELECTRICIAN'S SCISSORS

- ♦ **Lame microdentate in acciaio INOX**
Stainless steel micro-toothed blades
- ♦ **Manici antiscivolo in bicomponente bicolore con rivestimento in gomma termoplastica delle parti soggette ad usura che garantisce un elevato comfort nell'utilizzo prolungato**
Bi-component non-slip handles with two-tone coating thermoplastic rubber of the parts subject to wear that guarantees high comfort in prolonged use
- ♦ **Perno con bullone regolabile**
Pin with adjustable bolt

Codice	Pezzi / Pieces	mm	gr		Barcode
230834		160	80	12	8033183560377
230834P	Con portafortice / With scissors holder			12	8033183586551
238034	24 Espositore / Exhibitor art. 230834			1	8033183569189



230810 FORBICI PER ELETTRICISTI ELECTRICIAN'S SCISSORS

- ♦ **Lame microdentate in acciaio forgiato con esecuzione brunita**
Forged steel micro-toothed blades with burnished execution
- ♦ **Manici plastificati**
Plastic coated handles
- ♦ **Funzione tagliacavo sulla lama**
Cable cutting function on the blade

Codice	Pezzi / Pieces	mm	gr		Barcode
230810		145	95	12	8033116539579
238010	24 Espositore / Exhibitor art. 230810			1	8033116532099



230810P FORBICI PER ELETTRICISTI PROFESSIONALI PROFESSIONAL ELECTRICIAN'S SCISSORS

- ◆ Lame microdentate in acciaio forgiato con esecuzione brunita
Forged steel micro-toothed blades with burnished execution
- ◆ Manici plastificati
Plastic coated handles
- ◆ Funzione tagliacavo sulla lama
Cable cutting function on the blade

Codice	Pezzi / Pieces	mm	gr		Barcode
230810P		145	90	12	8033183568175
238010P	24	Espositore / Exhibitor art. 230810P		1	8033183569172



230830 FORBICI PER ELETTRICISTI ELECTRICIAN'S SCISSORS

- ◆ Lame microdentate in acciaio INOX
Stainless steel micro-toothed blades
- ◆ Manici in ABS
ABS handle

Codice	Pezzi / Pieces	mm	gr		Barcode
230830		145	56	12	8033116539616
238030	24	Espositore / Exhibitor art. 230830		1	8033116539685



230201 FORBICI PER ELETTRICISTI CON TAGLIACAVO ELECTRICIAN'S SCISSORS WITH CABLE CUTTER

- ◆ Lame microdentate in acciaio forgiato con esecuzione nichelata
Forged steel nickel plated microtoothed blades
- ◆ Manici plastificati
Plasticized handles
- ◆ Funzione tagliacavo sulla lama
Cable cutting function on the blade

Codice	Pezzi / Pieces	mm	gr		Barcode	
230201		Lama retta / Straight blade	145	115	12	8033116531672
230301		Lama curva / Curved blade	145	115	12	8033116539524
238002	24	Espositore / Exhibitor art. 230201		1	8033116532259	



230837 FORBICI PER ELETTRICISTI CON TAGLIACAVO ELECTRICIAN'S SCISSORS WITH CABLE CUTTER

- ◆ Lame microdentate in acciaio INOX
Stainless steel micro-toothed blades
- ◆ Manici antiscivolo in ABS bicolore con rivestimento in gomma termoplastica delle parti soggette ad usura che garantisce un elevato comfort nell'utilizzo prolungato
Non-slip handles in two-tone ABS with rubber coating thermoplastic of the parts subject to wear which guarantees a high comfort in prolonged use
- ◆ Perno con bullone regolabile
Pin with adjustable bolt

Codice	Pezzi / Pieces	mm	gr		Barcode
230837		145	60	12	8033116537537
238037	24	Espositore / Exhibitor art. 230837		1	8033116539715



230836 FORBICI PER ELETTRICISTI CON TAGLIACAVO
ELECTRICIAN'S SCISSORS WITH CABLE CUTTER

- ◆ Lame microdentate in acciaio INOX
Stainless steel micro-toothed blades
- ◆ Manici antiscivolo in ABS bicolore con rivestimento in gomma termoplastica delle parti soggette ad usura che garantisce un elevato comfort nell'utilizzo prolungato
Non-slip handles in two-tone ABS with rubber coating thermoplastic of the parts subject to wear which guarantees a high comfort in prolonged use
- ◆ Perno con bullone regolabile
Pin with adjustable bolt
- ◆ Funzione tagliacavo sulla lama
Cable cutting function on the blade

Codice	Pezzi / Pieces	mm	gr		Barcode
230836		145	64	12	8033116537537
238036	24	Espositore / Exhibitor art. 230836		1	8033116539715



230838 FORBICI PER ELETTRICISTI CON TAGLIACAVO
ELECTRICIAN'S SCISSORS WITH CABLE CUTTER

- ◆ Lame microdentate in acciaio INOX
Stainless steel micro-toothed blades
- ◆ Manici antiscivolo in ABS bicolore con rivestimento in gomma termoplastica delle parti soggette ad usura che garantisce un elevato comfort nell'utilizzo prolungato
Non-slip handles in two-tone ABS with rubber coating thermoplastic of the parts subject to wear which guarantees a high comfort in prolonged use
- ◆ Perno con bullone regolabile
Pin with adjustable bolt
- ◆ Funzione tagliacavo su entrambe le lame **1**
Cable cutting function on both blades

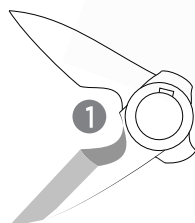

Codice	Pezzi / Pieces	mm	gr		Barcode
230838		145	64	12	8033183556844
238038	24	Espositore / Exhibitor art. 230838		1	8033183559036



230835 FORBICI PER ELETTRICISTI CON TAGLIACAVO
ELECTRICIAN'S SCISSORS WITH CABLE CUTTER

- ◆ Lame microdentate in acciaio INOX
Stainless steel micro-toothed blades
- ◆ Manici in ABS
ABS handle
- ◆ Funzione tagliacavo sulla lama
Cable cutting function on the blade
- ◆ Perno con bullone regolabile
Pin with adjustable bolt

Codice	Pezzi / Pieces	mm	gr		Barcode
230835		145	64	12	8033116539661
238035	24	Espositore / Exhibitor art. 230835		1	8033116539708



230002 FORBICI PER ELETTRICISTI CON TAGLIACAVO
ELECTRICIAN'S SCISSORS WITH CABLE CUTTER

- ♦ Lame microdentate in acciaio forgiato con esecuzione nichelata
Forged steel nickel plated microtoothed blades
- ♦ Funzione tagliacavo sulla lama
Cable cutting function on the blade

Codice		mm	gr		Barcode
230002	Lama retta / <i>Straight blade</i>	145	90	12	8033116539456
230102	Lama curva / <i>Curved blade</i>	145	90	12	8033116539463



23007R FORBICI PER ELETTRICISTI CON TAGLIACAVO
ELECTRICIAN'S SCISSORS WITH CABLE CUTTER

- ♦ Lame microdentate in acciaio forgiato con esecuzione nichelata
Forged steel nickel plated microtoothed blades
- ♦ Manici in materiale plastico antiscivolo
Non-slip plastic handles
- ♦ Funzione tagliacavo sulla lama
Cable cutting function on the blade

Codice		mm	gr		Barcode
23007R	Lama retta / <i>Straight blade</i>	145	80	12	8033116539456
23008C	Lama curva / <i>Curved blade</i>	145	80	12	8033116539593



230005 FORBICI PER ELETTRICISTI CON TAGLIACAVO
ELECTRICIAN'S SCISSORS WITH CABLE CUTTER

- ♦ Lame microdentate in acciaio forgiato con esecuzione nichelata
Forged steel nickel plated microtoothed blades
- ♦ Manici in materiale plastico antiscivolo
Non-slip plastic handles
- ♦ Funzione tagliacavo sulla lama
Cable cutting function on the blade

Codice		mm	gr		Barcode
230005	Lama retta / <i>Straight blade</i>	130	80	12	8033116539470
230106	Lama curva / <i>Curved blade</i>	130	80	12	8033116539487



Forbici telefonista

Telephonist scissors

230404N FORBICI TELEFONISTA TALLONE PIATTO FLAT HEEL TELEPHONIST SCISSORS

- ◆ Lame corte in acciaio forgiato con finitura nichelata
Short blades in forged steel with nickel-plated finish
- ◆ Finitura completamente nichelata
Fully nickel-plated finish
- ◆ Funzione tagliacavo sulla lama
Cable cutting function on the blade

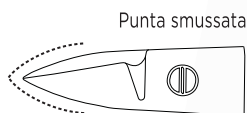

Codice	mm	gr		Barcode
230404N	145	110	12	8033183843340

230404P FORBICI TELEFONISTA TALLONE PIATTO ROUND HEEL TELEPHONIST SCISSORS

- ◆ Lame corte in acciaio forgiato con finitura nichelata
Short blades in forged steel with nickel-plated finish
- ◆ Manici in materiale plastico antiscivolo
Non-slip plastic handles
- ◆ Funzione tagliacavo sulla lama
Cable cutting function on the blade

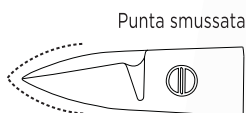

Codice	mm	gr		Barcode
230404P	145	110	12	8033183843357

230401N FORBICI TELEFONISTA TALLONE TONDO ROUND HEEL TELEPHONIST SCISSORS

- ◆ Lame corte in acciaio forgiato con finitura nichelata
Short blades in forged steel with nickel-plated finish
- ◆ Funzione tagliacavo sulla lama
Cable cutting function on the blade

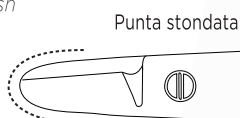

Codice	mm	gr		Barcode
230401N	145	110	12	8033183843371

230401P FORBICI TELEFONISTA TALLONE TONDO ROUND HEEL TELEPHONIST SCISSORS

- ◆ Lame corte in acciaio forgiato con finitura nichelata
Short blades in forged steel with nickel-plated finish
- ◆ Manici in materiale plastico antiscivolo
Non-slip plastic handles
- ◆ Funzione tagliacavo sulla lama
Cable cutting function on the blade

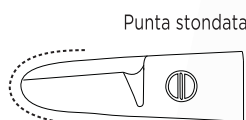

Codice	mm	gr		Barcode
230401P	145	110	12	8033183843364



TAGLIO PRECISO MASSIMO COMFORT

PRECISE CUT MAXIMUM COMFORT



LINEA PRO
PRO LINE

- 21** Cesoie taglialamiera
Sheet metal shears
- 26** Cesoie multiuso
Multi-purpose shears
- 29** Cesoie per orefice
Goldsmith's shears



Cesoie taglialamiera

Sheet metal shears

- 1** **Lame microdentate in acciaio al cromo molibdeno.**
Micro-toothed steel blades with chromium -molybdenum.
- 2** **Molla per apertura automatica per un utilizzo più agevole e sistema di bloccaggio di sicurezza per chiudere il lucchetto quando la cesoia non è in uso.**
Spring for automatic opening for easier use and locking system safety lock to close the padlock when the shear is not in use.
- 3** **Impugnatura ergonomica plastificata con paramani per una maggior sicurezza.**
Ergonomic plasticized handle with hand guards for greater safety.

229501 CESCOIE PER LAMIERA TAGLIO DRITTO STRAIGHT CUT SHEARS

- Durezza delle lame 58/60 HRC
Blades hardness 58/60 HRC
- Taglio dritto
Straight cut



Codice		mm	gr		Barcode
229501		250	480	6	8033183551542

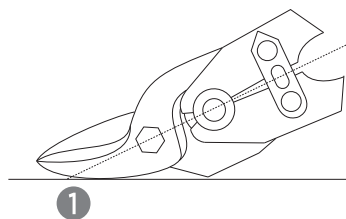

229601 CESCOIE PER LAMIERA MANO SINISTRA LEFT HAND SHEET SHEARS

- Durezza delle lame 58/60 HRC
Blades hardness 58/60 HRC
- Per tagli dritti e sagomati
For straight and shaped cuts
- Speciale angolatura di taglio per non sbattere la mano contro il materiale da tagliare **1**
Special cutting angle to avoid banging your hand against the material to be cut



Codice		mm	gr		Barcode
229601		250	480	6	8033116536202



229701 CESOIE PER LAMIERA MANO DESTRA RIGHT HAND SHEET SHEARS

- Durezza delle lame 58/60 HRC
Blades hardness 58/60 HRC
- Per tagli dritti e sagomati
For straight and shaped cuts
- Speciale angolatura di taglio per non sbattere la mano contro il materiale da tagliare
Special cutting angle to avoid banging your hand against the material to be cut

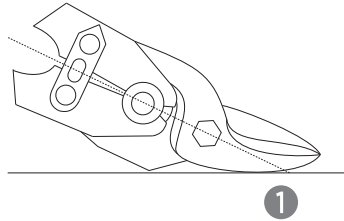

Codice		mm	gr		Barcode
229701		250	480	6	8033116531696

229801 CESOIE PER LAMIERA TAGLIO PASSANTE MANO SINISTRA SHEARS FOR SHEET CUT THROUGH LEFT HAND



- Durezza delle lame 63 HRC
Blades hardness 63 HRC
- Tagliante rinforzato con geometria speciale, impedisce alla lamiera di slittare
Reinforced cutting edge with special geometry, prevents the sheet from slipping
- Speciale angolatura di taglio per non sbattere la mano contro il materiale da tagliare
Special cutting angle to avoid banging your hand against the material to be cut

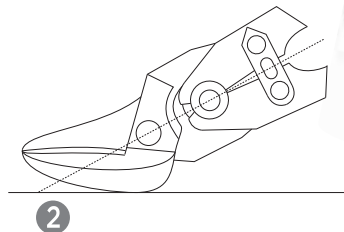
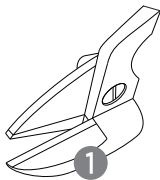

Codice		mm	gr		Barcode
229801		260	550	6	8033116536219

229901 CESOIE PER LAMIERA TAGLIO PASSANTE MANO DESTRA SHEARS FOR SHEET CUT THROUGH RIGHT HAND



- Durezza delle lame 63 HRC
Blades hardness 63 HRC
- Tagliante rinforzato con geometria speciale, impedisce alla lamiera di slittare
Reinforced cutting edge with special geometry, prevents the sheet from slipping
- Speciale angolatura di taglio per non sbattere la mano contro il materiale da tagliare
Special cutting angle to avoid banging your hand against the material to be cut

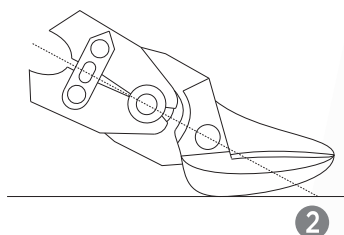
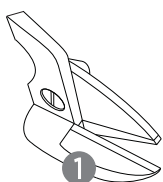

Codice		mm	gr		Barcode
229901		260	550	6	8033116536226

Cesoie per lamiera **universali**

Universal sheet metal shears

- 1** In acciaio al carbonio di alta qualità con ganasce forgiate.
Made of carbon high quality steel with forged jaws.
- 2** Lame temperate a induzione con durezza 58-61 HRC ideali per tagliare con grande precisione e sicurezza lamiere d'acciaio, cemento armato, fili ed altri materiali.
Induction hardened blades with hardness 58-61 HRC ideal for cutting with great precision and safety steel sheets, reinforced concrete, wires and other materials.
- 3** Impugnatura con presa isolata rivestita in PVC.
Handle with insulated PVC coated grip.

226428 CESCOIE PER LAMIERA UNIVERSALI
TAGLIO DESTRO
UNIVERSAL SHEARS, RIGHT CUT

Codice	mm	gr		Barcode
226428	280	500	6	8033116536165

226528 CESCOIE PER LAMIERA UNIVERSALI
TAGLIO SINISTRO
UNIVERSAL SHEARS LEFT CUT

Codice	mm	gr		Barcode
226528	280	500	6	8033116536172

226626 CESCOIE PER LAMIERA UNIVERSALI
TAGLIO DESTRO
UNIVERSAL SHEARS, RIGHT CUT

Codice	mm	gr		Barcode
226626	260	500	6	8033116536288

226024 CESCOIE PER LAMIERA UNIVERSALI
TAGLIO DRITTO
UNIVERSAL SHEARS LEFT CUT

Codice	mm	gr		Barcode
226024	260	450	6	8033116536257



226327 CESOIE PER LAMIERA UNIVERSALI
TAGLIO DRITTO
UNIVERSAL STRAIGHT CUT

Codice	mm	gr		Barcode
226327	270	500	6	8033116536271

226801 CESOIE PER LAMIERA UNIVERSALI
TAGLIO PASSANTE SINISTRO
UNIVERSAL SHEARS LEFT THROUGH CUT

Codice	mm	gr		Barcode
226801	280	500	6	8033116536189

226901 CESOIE PER LAMIERA UNIVERSALI
TAGLIO PASSANTE DESTRO
UNIVERSAL SHEARS RIGHT THROUGH CUT

Codice	mm	gr		Barcode
226901	280	500	6	8033116536196

226730S CESOIE PER LAMIERA UNIVERSALI PELIKAN
UNIVERSAL SHEET SHEARS PELIKAN MODEL

- ♦ Taglio sinistro
Left cut

Codice	mm	gr		Barcode
226730S	300	650	3	8033183561961

226730D CESOIE PER LAMIERA UNIVERSALI PELIKAN
UNIVERSAL SHEET SHEARS PELIKAN MODEL

- ♦ Taglio destro
Right cut

Codice	mm	gr		Barcode
226730D	300	650	3	8033183561954
226735	350	800	3	8033116536301



225522 CESCOIE PER LAMIERA ITALIA
PLATE SHEARS "ITALIA" MODEL

- ♦ Corpo in acciaio al carbonio
Carbon steel body
- ♦ Esecuzione brunita
Burnished execution
- ♦ Impugnatura rivestita in plastica con ampi anelli
Plastic coated handle with large rings
- ♦ Per il taglio di lamiere di metalli morbidi e acciaio
For cutting soft metal sheets and steel



Codice	mm	gr		Barcode
225522	220	350	6	8033116531634
225524	240	460	6	8033116530248
225526	260	485	6	8033116532112
225528	280	685	6	8033116536103
225530	300	745	6	8033116531122
225540	400	1400	6	8033116536110

228620 CESCOIE PER LAMIERA AMERICA
PLATE SHEARS "AMERICA" MODEL

- ♦ Corpo in acciaio al carbonio
Carbon steel body
- ♦ Esecuzione brunita
Burnished execution
- ♦ Impugnatura rivestita in plastica con ampi anelli
Plastic coated handle with large rings
- ♦ Manici lunghi e massicci per consentire una pressione maggiore
Long, chunky handles to allow for more pressure
- ♦ Per il taglio di lamiere di metalli morbidi e acciaio
For cutting soft metal sheets and steel



Codice	mm	gr		Barcode
228620	200	240	6	8033116536127
228625	250	450	6	8033116532686
228630	300	780	6	8033116536134

228720 CESCOIE PER LAMIERA AMERICA
PLATE SHEARS "AMERICA" MODEL

- ♦ Corpo in acciaio al carbonio
Carbon steel body
- ♦ Esecuzione brunita
Burnished execution
- ♦ Impugnatura rivestita in plastica con ampi anelli
Plastic coated handle with large rings
- ♦ Manici lunghi e massicci per consentire una pressione maggiore
Long, chunky handles to allow for more pressure
- ♦ Per il taglio di lamiere di metalli morbidi e acciaio
For cutting soft metal sheets and steel
- ♦ Modello stretto
Narrow model



Codice	mm	gr		Barcode
228720	200	255	6	8033116536141

Cesoie multiuso

Multipurpose shears

- 1** **Lame microdentate in acciaio INOX temperato.**
Micro-toothed blades in tempered stainless steel.
- 2** **Molla di richiamo per ottimizzare lo sforzo di taglio e sistema di bloccaggio di sicurezza per chiudere il lucchetto quando la cesoia non è in uso.**
Return spring to optimize the cutting effort and locking system safety lock to close the padlock when the shear is not in use.
- 3** **Impugnatura rivestita in polipropilene con presa in materiale antiscivolo.**
Polypropylene coated handle with grip in non-slip material.
- 4** **Vite centrale con dado regolabile autobloccante.**
Central screw with self-locking adjustable nut.

230821B FORBICI MULTIUSO BICOLORE BI-COLOR MULTIPURPOSE SCISSORS

- Durezza lame 60 HRC
Blade hardness 60 HRC
- Bullone M5
M5 Bolt

Codice	mm	gr		Barcode
230821B	190	125	12	8033183551573



230831B FORBICI MULTIUSO BICOLORE LAMA ORIZZONTALE MULTIPURPOSE BI-COLOR HORIZONTAL BLADE SCISSORS

- Lama pensata per favorire un taglio orizzontale per facilitare il lavoro evitando che le dita urtino contro la superficie di appoggio **1**
Blade designed to facilitate a horizontal cut to make work easier avoiding that fingers bump against the support surface
- Durezza lame 60 HRC
Blade hardness 60 HRC
- Bullone M5
M5 Bolt

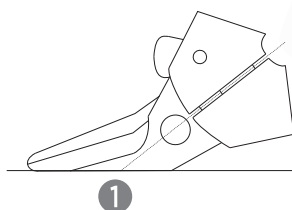

Codice	mm	gr		Barcode
230831B	185	122	12	8033183551566



230850B TAGLIACAVO BICOLORE BI-COLOR CABLE CUTTER

- ◆ Durezza lame 60 HRC
Blade hardness 60 HRC
- ◆ Funzione tagliacavo sulla lama
Cable cutting function on the blade
- ◆ Bullone M5
M5 bold

Codice	mm	gr		Barcode
230850B	165	122	12	8033183551559



230822 FORBICI MULTIUSO DOPPIA APERTURA DOUBLE OPENING MULTIPURPOSE SCISSORS

PATENTED

- ◆ Durezza lame 60 HRC
Blade hardness 60 HRC
- ◆ Doppia apertura S/L per adeguare l'apertura del taglio alla dimensione della mano (2 posizioni di taglio: 24 mm - 31 mm)
Double opening S / L to adapt the opening of the cut to the hand size (2 cutting positions: 24mm - 31mm)



Brevetto di utilità Fumasi: **PAT. 0000265248**
Fumasi utility patent: PAT. 0000265248

Codice	mm	gr		Barcode
230822	190	175	6	8033183551368
223943	Espositore / Exhibitor pz. 12		1	8033183551528

230823 FORBICI MULTIUSO BICOLORE MULTIPURPOSE BI-COLOR SCISSORS

- ◆ Finitura della lama satinata
Satin blade finish
- ◆ Molla in acciaio INOX che riduce l'affaticamento della mano
Stainless steel spring that reduces hand fatigue
- ◆ Funzione tagliacavo sulla lama per fili sottili
Cable cutting function on the blade for fine threads



Codice	mm	gr		Barcode
230823	190	121	6	8033183559418

230821 FORBICI MULTIUSO PROFESSIONALI PROFESSIONAL MULTIPURPOSE SCISSORS

- ◆ Rifinitura manuale delle lame
Manual finishing of the blades
- ◆ Lame con spessore di 3 mm
Thick blades 3 mm
- ◆ Bullone M5
M5 bold



Codice	mm	gr		Barcode
230821	150	45	12	8033116533348

230831 FORBICI MULTIUSO PROFESSIONALI LAMA ORIZZONTALE PROFESSIONAL MULTIPURPOSE HORIZONTAL BLADE SCISSORS

- ◆ Lama pensata per favorire un taglio orizzontale per facilitare il lavoro evitando che le dita urtino contro la superficie di appoggio
Blade designed to facilitate a horizontal cut to make work easier avoiding that fingers bump against the support surface
- ◆ Rifinitura manuale delle lame con spessore di 3 mm
Manual finishing of the blades with a thickness of 3 mm
- ◆ Bullone M5
M5 Bolt

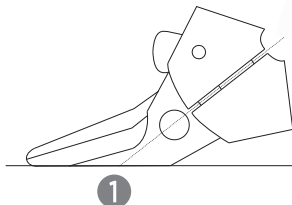

Codice	mm	gr		Barcode
230831	185	100	12	8033116539647

230850 TAGLIACAVO PROFESSIONALE PROFESSIONAL CABLE CUTTER

- ◆ Rifinitura manuale delle lame
Manual finishing of the blades
- ◆ Lame con spessore di 3 mm
Thick blades 3 mm
- ◆ Bullone M5
M5 Bolt
- ◆ Funzione tagliacavo sulla lama
Cable cutting function on the blade



Codice	mm	gr		Barcode
230850	165	110	12	8033116539623

223941 ESPOSITORE FORBICI MULTIUSO PROFESSIONALI EXHIBITOR MULTIPURPOSE OF PROFESSIONAL SCISSORS

Codice	Pezzi / Pieces			Barcode
223941	12	4 x 230850 - 21 - 31	1	8033183551504



230821S FORBICI MULTIUSO STANDARD STANDARD MULTIPURPOSE SCISSORS

- ◆ Lame microdentate in acciaio INOX
Stainless steel micro-toothed blades
- ◆ Manici rivestiti in polipropilene
Polypropylene handles
- ◆ Bullone M6
M6 bolt
- ◆ Modello leggero
Lightweight model



Codice		mm	gr		Barcode
230820	Spessore lama / Blade: 2,4 mm	150	45	12	8033116539630
230821S	Spessore lama / Blade: 2,4 mm	190	100	12	8033183552181

230850S TAGLIACAVO STANDARD STANDARD CABLE CUTTER

- ♦ Lame microdentate in acciaio INOX
Stainless steel micro-toothed blades
- ♦ Manici rivestiti in polipropilene
Polypropylene handles
- ♦ Bullone M6
M6 bolt
- ♦ Funzione tagliacavo sulla lama
Cable cutting function on the blade
- ♦ Modello leggero
Lightweight model



Codice		mm	gr		Barcode
230850S	Spessore lama / Blade: 2,4 mm	165	110	12	8033183553492

Cesoie per orefice Goldsmith shears

228821 CESCOIE PER OREFICE GOLDSMITH SHEARS

- ♦ Lame in acciaio al carbonio forgiato
Forged carbon steel blades
- ♦ Manici a cerchio chiusi verniciati blu
Blue painted closed circle handles
- ♦ Articolazione regolabile a vite
Adjustable screw joint
- ♦ Modello leggero
Lightweight model



Codice		mm	gr		Barcode
228821	Lama acuta retta / Straight blade	180	100	6	8033183569028
228921	Lama acuta curva / Curved blade	180	100	6	8033183569035

229021 CESCOIE PER OREFICE CON MOLLA GOLDSMITH SHEARS WITH SPRING

- ♦ Lame in acciaio al carbonio forgiato
Forged carbon steel blades
- ♦ Manici a cerchio chiusi verniciati blu
Blue painted closed circle handles
- ♦ Articolazione regolabile a vite
Adjustable screw joint
- ♦ Con molla di ritorno che riduce l'affaticamento e consente un taglio continuo
With return spring that reduces fatigue and allows continuous cutting
- ♦ Modello leggero
Lightweight model



Codice		mm	gr		Barcode
229021	Lama acuta retta / Straight blade	190	118	6	8033183556691
229121	Lama acuta curva / Curved blade	190	118	6	8033116535915

220121 CESOIE PER OREFICE BRUNITE SLIM
SLIM BURNISHED GOLDSMITH'S SHEARS

- Lame in acciaio al carbonio forgiato
Forged carbon steel blades
- Manici a cerchio chiusi
Closed circle handles
- Interamente brunita
Entirely burnished
- Articolazione regolabile a vite
Adjustable screw joint



Codice		mm	gr		Barcode
220121	Lama acuta retta / <i>Straight blade</i>	175	145	6	8033183843470
220221	Lama acuta curva / <i>Curved blade</i>	175	145	6	8033183843487

229001 CESOIE PER OREFICE
GOLDSMITH SHEARS

- Lame in acciaio al carbonio forgiato
Forged carbon steel blades
- Manici a cerchio chiusi verniciati neri
Black painted closed circle handles
- Articolazione regolabile a vite
Adjustable screw joint



Codice		mm	gr		Barcode
229001	Lama smussata retta / <i>Straight blade</i>	190	118	6	8033116536011
229101	Lama smussata curva / <i>Curved blade</i>	190	118	6	8033116536028

229026 CESOIE PER OREFICE
GOLDSMITH SHEARS

- Lame in acciaio al carbonio forgiato
Forged carbon steel blades
- Manici aperti verniciati neri
Black painted open handles
- Articolazione regolabile a vite
Adjustable screw joint



Codice		mm	gr		Barcode
229026	Lama smussata retta / <i>Straight blade</i>	180	113	6	8033116535960
229126	Lama smussata curva / <i>Curved blade</i>	180	113	6	8033116535977

229301 CESOIE PER OREFICE LAMA LARGA
GOLDSMITH'S SHEARS LARGE BLADE

- Lame in acciaio al carbonio forgiato
Forged carbon steel blades
- Manici a cerchio chiusi verniciati neri
Black painted closed circle handles



Codice		mm	gr		Barcode
229301		160	230	6	8033116536035
229302		180	250	6	8033116536042

229027 CESCOIE PER OREFICE GOLDSMITH SHEARS

- ♦ Lame in acciaio al carbonio forgiato
Forged carbon steel blades
- ♦ Manici ad anello verniciati neri
Black painted ring handles
- ♦ Articolazione regolabile a vite
Adjustable screw joint



Codice		mm	gr		Barcode
229027	Lama acuta retta / <i>Straight blade</i>	180	91	6	8033116535908
229127	Lama acuta curva / <i>Curved blade</i>	180	110	6	8033116535984

229025 CESCOIE PER OREFICE GOLDSMITH SHEARS

- ♦ Lame microdentate in acciaio al carbonio forgiato
Micro-toothed forged carbon steel blades
- ♦ Manici aperti rivestiti in plastica
Open plastic handles
- ♦ Articolazione regolabile a vite
Adjustable screw joint



Codice		mm	gr		Barcode
229025	Lama smussata retta / <i>Straight blade</i>	180	121	6	8033116535946
229125	Lama smussata curva / <i>Curved blade</i>	180	121	6	8033116535953

229226 CESCOIE PER OREFICE GOLDSMITH SHEARS

- ♦ Lame microdentate in acciaio al carbonio forgiato
Micro-toothed forged carbon steel blades
- ♦ Manici aperti rivestiti in plastica
Open plastic handles
- ♦ Esecuzione brunita
Burnished execution
- ♦ Bullone regolabile
Adjustable bolt



Codice		mm	gr		Barcode
229226	Lama smussata retta / <i>Straight blade</i>	185	136	6	8033183569066
229326	Lama smussata curva / <i>Curved blade</i>	185	136	6	8033183569080

229426 CESCOIE PER OREFICE GOLDSMITH SHEARS

- ♦ Lame microdentate in acciaio al carbonio forgiato
Micro-toothed forged carbon steel blades
- ♦ Manici aperti rivestiti in plastica
Open plastic handles
- ♦ Esecuzione brunita
Burnished execution
- ♦ Bullone regolabile
Adjustable bolt

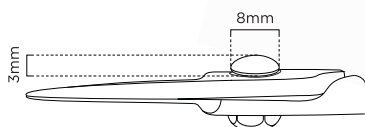

Codice		mm	gr		Barcode
229426	Lama smussata retta / <i>Straight blade</i>	185	136	6	8033183843494
229526	Lama smussata curva / <i>Curved blade</i>	185	136	6	8033183843500

229203 CESOIE PER OREFICE
GOLDSMITH SHEARS

- ♦ Lame microdentate in acciaio al carbonio forgiato
Micro-toothed forged carbon steel blades
- ♦ Manici aperti rivestiti in plastica
Open plastic handles
- ♦ Esecuzione brunita
Burnished execution
- ♦ Bullone regolabile
Adjustable bolt



Codice		mm	gr		Barcode
229203	Lama smussata retta / <i>Straight blade</i>	190	140	6	8033183569042
229204	Lama smussata curva / <i>Curved blade</i>	190	140	6	8033183569059

229227 CESOIE PER OREFICE
GOLDSMITH SHEARS

- ♦ Lame microdentate in acciaio al carbonio forgiato
Micro-toothed forged carbon steel blades
- ♦ Manici ad anello rivestiti in plastica
Plastic coated ring handles
- ♦ Esecuzione brunita
Burnished execution
- ♦ Articolazione regolabile a vite
Adjustable screw joint



Codice		mm	gr		Barcode
229227	Lama acuta retta / <i>Straight blade</i>	185	91	6	8033183569073
229327	Lama acuta curva / <i>Curved blade</i>	185	91	6	8033183569097



UN TAGLIO PER OGNI ESIGENZA

A CUT FOR EVERY NEED



LINEA PRO
PRO LINE

34 Forbici multiuso
Multipurpose scissors

37 Utensili da taglio
Cutting tools

Forbici multiuso

Multipurpose scissors

223240 FORBICI DA LAVORO TIPO FRANCESE FRENCH TYPE WORK SCISSORS

- Interamente in acciaio al carbonio C50 rivestito in nickel
Entirely in C50 carbon steel coated with nickel
- Lame con durezza di 52/56 HRC, rifinite con macchine di estrema precisione
Blades with hardness of 52/56 HRC, finished with machines of extreme precision
- Manico ad anelli simmetrici
Reverse symmetrical handle

Codice	mm	gr		Barcode
223240	105	36	12	8033116544498
223245	115	48	12	8033116544504
223250	125	60	12	8033116544511
223255	140	65	12	8033116544528



Codice	mm	gr		Barcode
223260	155	79	12	8033116544535
223265	165	88	12	8033116544542
223270	180	110	12	8033116544559
223280	205	135	12	8033116544566

223140 FORBICI MERCANTE TIPO FRANCESE MERCHANT SCISSORS FRENCH TYPE

- Interamente in acciaio al carbonio C50 rivestito in nickel
Entirely in C50 carbon steel coated with nickel
- Punta arrotondate e lame con durezza di 52/56 HRC, rifinite con macchine di estrema precisione
Rounded tips and blades with hardness of 52/56 HRC, finished with machines of extreme precision
- Manico ad anelli simmetrici
Reverse symmetrical handle

Codice	mm	gr		Barcode
223140	105	35	12	8033116545587
223150	125	59	12	8033116545600
223160	155	73	12	8033116545624



223560 FORBICI SARTINA TAILORING SCISSORS

- Interamente in acciaio al carbonio C50 rivestito in nickel
Entirely in C50 carbon steel coated with nickel
- Lama con durezza di 52/56 HRC, rifinita con macchine di estrema precisione
Blade with hardness of 52/56 HRC, finished with machines of extreme precision
- Manico ad anelli asimmetrici per un massimo comfort
Asymmetrical ring handle for maximum comfort

Codice	mm	gr		Barcode
223560	155	120	12	8033116544610
223570	180	150	12	8033116544634
223580	205	170	12	8033116544658



3607NV07 FORBICI PER SARTO TAILOR SCISSORS

- Lame in acciaio al carbonio C50 rivestite in nickel con durezza di 52/56 HRC temperate a sale
C50 carbon steel blades coated with nickel with hardness of 52/56 HRC tempered with salt
- Manici ergonomici con verniciatura ad immersione color nero con anelli asimmetrici per meglio guidare il taglio e rendono agevole il lavoro anche agli operatori mancini
Ergonomic handles with black immersion paint with asymmetrical rings to better guide the cut and make it work is also easier for left-handed operators

Codice	mm	gr	📦	Barcode
3607NV07	180	160	6	8033116544849
3607NV08	205	220	6	8033116544856
3607NV09	230	250	6	8033116544863



Codice	mm	gr	📦	Barcode
3607NV10	255	300	6	8033116544870
3607NV11	280	500	6	8033116544887
3607NV12	380	550	6	8033116544894

223710 FORBICI MULTIUSO PROFESSIONALI PROFESSIONAL MULTIPURPOSE SCISSORS

- Lame in acciaio inossidabile AISI 420 temperato ad atmosfera con durezza 50/54 HRC
Atmosphere tempered AISI 420 stainless steel blades with hardness 50/54 HRC
- Manici ergonomici in nylon ultraleggeri con anelli asimmetrici (nelle misure grandi) per meglio guidare il taglio
Ergonomic handles in ultralight nylon with asymmetrical rings (in large sizes) to better guide the cut
- Sistema di fissaggio a vite con controdamo
Screw fixing system with lock nut

Codice	mm	gr	📦	Barcode
223710	155	46	6	8033183553416
223711	190	67	6	8033183552471
223712	210	85	6	8033183552297



Codice	mm	gr	📦	Barcode
223713	240	130	6	8033183552488
223714	260	138	6	8033183560667

233255T FORBICI MULTIUSO IN TITANIO MULTIPURPOSE SCISSORS TITANIUM COATED

- Lame microdentate in acciaio INOX temperato rivestite al titanio che ne garantisce un'estrema robustezza
Micro-toothed blades in tempered stainless steel coated with titanium that guarantees extreme strength
- Durezza lame 54 HRC
Hardness of blades 54 HRC
- Lame antiruggine e lavabili in lavastoviglie
Rustproof and dishwasher safe blades
- Manici in bimatereale con rivestimento in gomma delle parti soggette ad usura che garantisce un elevato comfort nell'utilizzo prolungato
Bi-material handles with rubber coating on the subject parts wear that guarantees high comfort in prolonged use
- Manici ad anelli asimmetrici (nelle misure grandi) per meglio guidare il taglio e rendono agevole il lavoro anche agli operatori mancini
Asymmetrical ring handles (in large sizes) for better guidance cutting and make work easier even for left-handed operators

Codice	Pezzi / Pieces	mm	gr	📦	Barcode
233255T		135	36	12	8033183552563
233265T		165	43	12	8033183552549
233480T		210	106	12	8033183553454
233490T		230	110	12	8033183552570
234380T	24	Espositore / Exhibitor 6 x 233255T - 65T; 6 x 233480T - 90T		1	8033183554055



233255TB FORBICI MULTIUSO IN TITANIO BRONZE
MULTIPURPOSE SCISSORS BRONZE TITANIUM COATED

- ♦ **Lame microdentate in acciaio INOX temperato rivestite al titanio BRONZE che ne garantisce un'estrema robustezza**
Micro-toothed blades in tempered stainless steel coated with titanium BRONZE which guarantees extreme robustness
- ♦ **Durezza lame 54 HRC**
Hardness of blades 54 HRC
- ♦ **Lame antiruggine e lavabili in lavastoviglie**
Rustproof and dishwasher safe blades
- ♦ **Manici in bimatereale con rivestimento in gomma delle parti soggette ad usura che garantisce un elevato comfort nell'utilizzo prolungato**
Bi-material handles with rubber coating on the subject parts wear that guarantees high comfort in prolonged use
- ♦ **Manici ad anelli asimmetrici (nelle misure grandi) per meglio guidare il taglio e rendono agevole il lavoro anche agli operatori mancini**
Asymmetrical ring handles (in large sizes) for better guidance cutting and make work easier even for left-handed operators

Codice	mm	📦	Barcode
233255TB	135	12	8033183843197
233265TB	165	12	8033183843203
233480TB	210	12	8033183843210
233490TB	230	12	8033183843227



233255TNS FORBICI MULTIUSO IN TITANIO NO STICK
MULTIPURPOSE SCISSORS NO STICK TITANIUM COATED

- ♦ **Lame microdentate in acciaio INOX temperato rivestite al titanio NO STICK che permette di tagliare fogli rivestiti di colla senza che ne rimanga nessun residuo tra le lame**
Micro-toothed blades in tempered stainless steel coated with titanium NO STICK that allows you to cut sheets coated with glue without that no residue remains between the blades
- ♦ **Durezza lame 54 HRC**
Hardness of blades 54 HRC
- ♦ **Lame antiruggine e lavabili in lavastoviglie**
Rustproof and dishwasher safe blades
- ♦ **Manici in bimatereale con rivestimento in gomma delle parti soggette ad usura che garantisce un elevato comfort nell'utilizzo prolungato**
Bi-material handles with rubber coating on the subject parts wear that guarantees high comfort in prolonged use
- ♦ **Manici ad anelli asimmetrici (nelle misure grandi) per meglio guidare il taglio e rendono agevole il lavoro anche agli operatori mancini**
Asymmetrical ring handles (in large sizes) for better guidance cutting and make work easier even for left-handed operators

Codice	mm	📦	Barcode
233255TNS	135	12	8033183843432
233265TNS	165	12	8033183843449
233480TNS	210	12	8033183843456
233490TNS	230	12	8033183843463



Utensili da taglio

Cutting tools

232101 CUTTER PROFESSIONALE PROFESSIONAL CUTTER

- Impugnatura in ABS rivestita in gomma antiscivolo
ABS handle covered with non-slip rubber
- Guida in acciaio inossidabile
Stainless steel guide
- Sistema autobloccaggio della lama a scatto
Snap blade self-locking system
- Pulsante di controllo del movimento della lama
Blade movement control button
- Con serbatoio lame
With blade reservoir

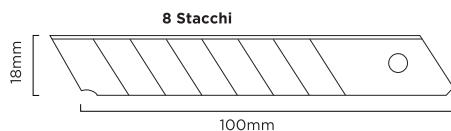

Codice		mm		Barcode
232101	Lama / Blade 100 x 18mm	170	12	8033116531849
232101A	Lama ricambio / Spare blade	100 x 18	10	8033183556134



232101P CUTTER PROFESSIONALE A VITE PROFESSIONAL SCREW CUTTER

- Impugnatura in ABS rivestita in gomma antiscivolo
ABS handle covered with non-slip rubber
- Guidalama metallico, acciaio SK4
Metal blade guide
- Sistema di bloccaggio a vite, garantisce maggiore sicurezza
Screw locking system
- Con serbatoio lame
With blade reservoir
- Funzione spellafili
Stripping function

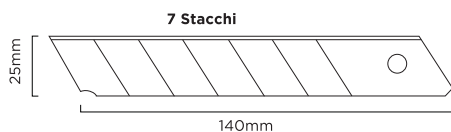

Codice		mm		Barcode
232101P	Lama / Blade 140 x 25mm	195	12	8033183840776
232101PA	Lama ricambio / Spare blade	140 x 25	10	8033183840875



232101PN CUTTER LAMA NERA BLACK BLADE CUTTER

- Impugnatura in ABS rivestita in gomma antiscivolo
ABS handle covered with non-slip rubber
- Lama nera in acciaio SK2
Black SK2 steel blade
- Sistema autobloccaggio della lama a scatto
Snap blade self-locking system
- Pulsante di controllo del movimento della lama
Blade movement control button
- Con serbatoio lame
With blade reservoir



Codice		mm		Barcode
232101N	Lama / Blade 100 x 18mm	170	12	8033183844538
232101PN	Lama / Blade 140 x 25mm	195	12	8033183843388
232101AN	Lama ricambio / Spare blade art. 232101N	100 x 18	10	8033183844545
232101PAN	Lama ricambio / Spare blade art. 232101PN	140 x 25	10	8033183844552

232106 CUTTER TASCABILE IN METALLO POCKET METAL CUTTER

- Impugnatura in metallo
Non-slip rubber handle
- Lama in argento SK4
SK4 silver blade
- Sistema autobloccaggio della lama a scatto
Snap blade self-locking system
- Pulsante di controllo del movimento della lama
Blade movement control button

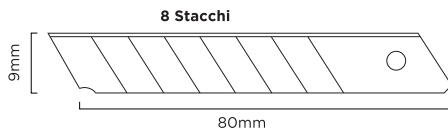

Codice		mm		Barcode
232106	Lama / Blade 80 x 9mm	130	12	8033183843395

232501P CUTTER IN METALLO ZINCATO GALVANIZED METAL CUTTER

- Impugnatura in metallo + gomma antiscivolo
Metal handle + non-slip rubber
- Lama in acciaio SK4
SK4 steel blade
- Sistema autobloccaggio della lama a scatto
Snap blade self-locking system
- Pulsante di controllo del movimento della lama
Blade movement control button
- Con serbatoio lame
With blade reservoir

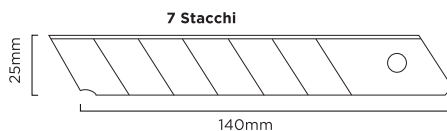

Codice		mm		Barcode
232501P	Lama / Blade 140 x 25mm	195	12	8033183843401

232701 CUTTER IN METALLO METAL BODY CUTTER



- ♦ Corpo in metallo
Metal body
- ♦ Impugnatura antiscivolo in gomma antiscivolo
Non-slip grip in non-slip rubber
- ♦ Pulsante di controllo movimento della lama
Blade movement control button
- ♦ Pulsante di rientro automatico della lama
Automatic blade retraction button

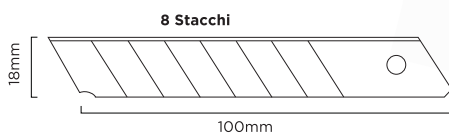

Codice		mm		Barcode
232701	Lama / Blade 100 x 18mm	170	12	8033183558831
232701A	Lama ricambio / Spare blade	100 x 18	10	8033183569127



232703 CUTTER IN ALLUMINIO ALUMINUM CUTTER

- ♦ Corpo in alluminio pressofuso
Die-cast aluminum body
- ♦ Rivestimento antiscivolo in morbida gomma sul retro
Non-slip soft rubber coating on the back
- ♦ Sistema autobloccaggio della lama a scatto
Snap blade self-locking system
- ♦ Pulsante di controllo movimento della lama
Blade movement control button

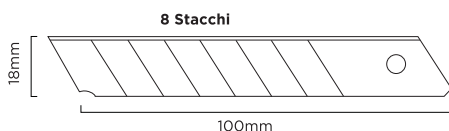

Codice		mm		Barcode
232703	Lama / Blade 100 x 18mm	155	12	8033183845726
232703A	Lama ricambio / Spare blade	100 x 18	10	8033183845733



232401 CUTTER IN ABS NERO ABS BLACK CUTTER

- ♦ Impugnatura in gomma antiscivolo
Non-slip rubber handle
- ♦ Lama in argento SK4
SK4 silver blade
- ♦ Sistema autobloccaggio della lama a scatto
Snap blade self-locking system
- ♦ Pulsante di controllo del movimento della lama
Blade movement control button

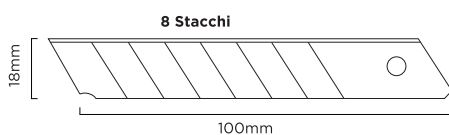

Codice		mm		Barcode
232401	Lama / Blade 100 x 18mm	170	12	8033183843418



232501 CUTTER ANTINFORTUNISTICO ACCIDENT PREVENTION CUTTER

- ♦ Corpo in lega di zinco
Zinc alloy body
- ♦ Cursore di controllo della lama
Blade control slider
- ♦ 3 posizioni della lama
3 blade positions
- ♦ Lama a trapezio
Trapezoid blade

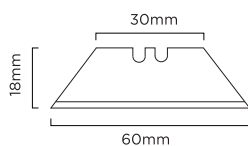

Codice		mm		Barcode
232501	Lama / Blade 60 x 18mm	150	12	8033116539876
232501A	Lama ricambio / Spare blade	60 x 18	10	8033183554727

232601 CUTTER ANTINFORTUNISTICO PIEGHEVOLE FOLDABLE ACCIDENT PREVENTION CUTTER

- ♦ Corpo in metallo
Metal body
- ♦ Impugnatura antiscivolo bicomponente
Bi-component non-slip handle
- ♦ Pulsante di controllo del blocco e sblocco della lama
Blade locking and unlocking control button
- ♦ Pulsante di controllo per l'apertura e la chiusura della lama
Control button for opening and closing the blade
- ♦ 1 posizione della lama
With blade reservoir

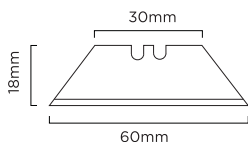

Codice		mm		Barcode
232601	Lama / Blade 60 x 18mm	170	12	8033183558428
232601A	Lama ricambio / Spare blade	60 x 18	10	8033183561848

232702 CUTTER ANTINFORTUNISTICO IN GOMMA RUBBER ACCIDENT PREVENTION CUTTER

- ♦ Corpo rivestito in morbida gomma antiscivolo nera
Body covered in soft black anti-slip rubber
- ♦ 2 pulsanti di controllo:
1 pulsante di controllo movimento della lama a 2 scatti
1 pulsante superiore a molla con rientro automatico della lama
*2 control buttons:
1 2-click blade movement control button
1 upper spring button with automatic blade retraction*
- ♦ Serbatoio lame nella parte superiore del manico
Blade reservoir in the upper part of the handle

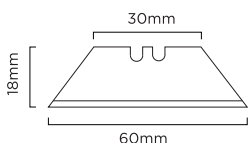

Codice		mm		Barcode
232702	Lama / Blade 60 x 18mm	180	12	8033183843425
232702A	Lama ricambio / Spare blade	60 x 18	10	8033183846266

232001 COLTELLO PER ELETTRICISTI PIEGHEVOLE FOLDING ELECTRICIAN KNIFE

- ♦ Lama in acciaio al carbonio C67 temperato
Tempered C67 carbon steel blade
- ♦ Manico in legno duro resistente agli agenti atmosferici
Weather resistant hardwood handle
- ♦ Funzione spelafili sulla lama
Stripping function on the blade

Codice	Lama mm	mm		Barcode
232001	90	195	6	8033116539852



232201 COLTELLO PER ELETTRICISTI PIEGHEVOLE FOLDING ELECTRICIAN KNIFE

- ♦ Lama in acciaio al carbonio C67 temperato
Tempered C67 carbon steel blade
- ♦ Manico in plastica dura
Hard plastic handle
- ♦ Funzione spelafili sulla lama
Stripping function on the blade

Codice	Lama mm	mm		Barcode
232201	70	195	6	8033116539569



232801 TAGLIAVETRO GLASS CUTTER

- ♦ Tagliente in metallo molto duro
Very hard metal cutting edge
- ♦ Corpo in metallo zigrinato antiscivolo
Anti-slip knurled metal body
- ♦ Dotato di pipetta lubrificante
Equipped with lubricant pipette

Codice	mm		Barcode
232801	175	12	8033116539569



L'ERGONOMIA NELLA TUA MANO

ERGONOMICS IN YOUR HAND



LINEA PRO
PRO LINE



1000 V

ISOLATO PER TENSIONE 1000V
INSULATED FOR 1000V VOLTAGE



CONFORME AGLI STANDARD EUROPEI
COMPLIES WITH EUROPEAN STANDARDSMENTS



CONFORME ALLE NORME DVE
COMPLIES WITH DVE STANDARDS



PUNTA MAGNETICA
MAGNETIC TIP



PUNTA A CROCE "POZIDRIV"
FOR "POZIDRIV" SCREW



PUNTA TORX CON FORO
FOR TORX SCREW WITH HOLE



PUNTA A INTAGLIO
FOR SLOTTED SCREW



PUNTA A CROCE "PHILLIPS"
FOR "PHILLIPS" SCREW

43 Giraviti universali
Universal screwdrivers

47 Giraviti per micro-elettrica
Micro-electric screwdrivers

48 Giraviti cercafase
Phase-seeking screwdrivers

50 Giraviti 1000 VOLT
1000 volt screwdrivers

02

Giraviti universali Universal screwdrivers

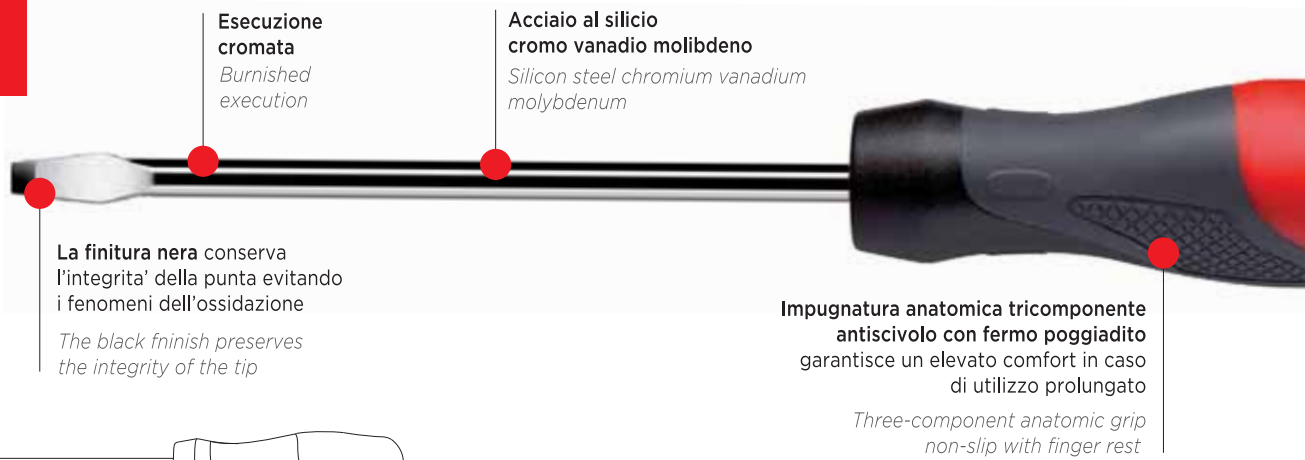

Esecuzione cromata
Burnished execution

Acciaio al silicio cromo vanadio molibdeno
Silicon steel chromium vanadium molybdenum

La finitura nera conserva l'integrità della punta evitando i fenomeni dell'ossidazione
The black finish preserves the integrity of the tip

Impugnatura anatomica tricomponente antiscivolo con fermo poggiadito
garantisce un elevato comfort in caso di utilizzo prolungato

Three-component anatomic non-slip with finger rest

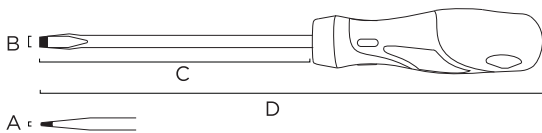

245020 GIRAVITI PROFESSIONALI PROFESSIONAL SCREWDRIVERS

Per viti con testa ad intaglio / *For slotted screws*



Fumari PRO

Codice	A x B mm	C mm	D mm	gr		Barcode
245020	0,5 x 3	100	185	45	12	8033116532815
245021	0,8 x 4	125	185	65	12	8033116531214
245022	1 x 5,5	125	225	80	12	8033116532822
245024	1,2 x 8	150	260	130	12	8033116532846
245026	1,2 x 8	175	395	235	12	8033116532860

245420 GIRAVITI PROFESSIONALI PROFESSIONAL SCREWDRIVERS

Per viti con impronta a croce "Phillips" / *For Phillips screws*



Fumari PRO

Codice	PH x B mm	C mm	D mm	gr		Barcode	
245420	PH0	0 x 3	60	145	40	12	8033116533270
245421	PH1	1 x 4,5	80	180	60	12	8033116531139
245422	PH2	2 x 6	100	210	115	12	8033116533287
245423	PH3	3 x 8	150	270	210	12	8033183551399

104020 SERIE GIRAVITI PROFESSIONALI PROFESSIONAL SCREWDRIVERS SET

Codice	Pezzi / pieces			Barcode
104020	5	1 x 245020 - 245021 - 245024 1 x 245421 - 245422	 	5 8033116534253



Fumari PRO

245520 GIRAVITI PROFESSIONALI PROFESSIONAL SCREWDRIVERS

Per viti con impronta a croce "Pozidriv" / For Pozidriv screws

Codice	PZ X B mm	C mm	D mm	gr		Barcode	
245520	PZ0	0 x 3	60	140	40	12	8033116533324
245521	PZ1	1 x 4,5	80	170	60	12	8033116533331
245522	PZ2	2 x 6	100	207	115	12	8033116530132
245523	PZ3	3 x 8	150	275	205	12	8033116530149



245622 - 245722 GIRAVITI PROFESSIONALI TIPO NANO PROFESSIONAL MINI SCREWDRIVERS

Codice		PH/A X B mm	C mm	D mm	gr		Barcode
245622		1 x 6,5	26	98	60	12	8033116533386
245722		2 x 2,5	26	88	55	12	8033116533362



Punta magnetica
per facilitare il lavoro
Magnetic tip

Acciaio al cromo molibdeno
Chromium-molybdenum alloy steel

Impugnatura anatomica bicomponente
resina + elastomero
Bi-component anatomic grip

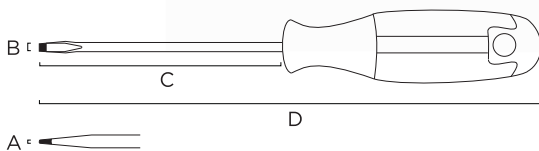

Protezione antiscivolo con superficie incavata
Non-slip protection with sunken surface

255001 GIRAVITI PER MECCANICI MECHANIC SCREWDRIVERS

Per viti con testa ad intaglio / For slotted screws

Codice	A X B mm	C mm	D mm	gr		Barcode
255001	0,5 x 3	75	156	45	12	8033116532723
255003	0,8 x 4	100	170	65	12	8033116533591
255006	1 x 5	125	215	75	12	8033116533621
255009	1,2 x 6	125	232	125	12	8033116533638
255011	1,6 x 8	150	275	210	12	8033116533676
255012	1,6 x 8	200	325	235	12	8033116533683



255201 GIRAVITI PER MECCANICI PUNTA LUNGA LONG TIP MECHANIC SCREWDRIVERS

Per viti con testa ad intaglio / For slotted screws

Codice	A X B mm	C mm	D mm	gr		Barcode
255201	0,5 x 2,5	75	156	30	12	8033116533690
255203	0,6 x 3	75	156	35	12	8033116532365
255204	0,6 x 3	100	156	40	12	8033116533706
255207	0,8 x 4	100	190	65	12	8033116533713
255208	0,8 x 4	150	190	70	12	8033116533720



255401 GIRAVITI PER MECCANICI MECHANIC SCREWDRIVERS

Per viti con impronta a croce "phillips" / For Phillips screws

Codice		PH x B mm	C mm	D mm	gr		Barcode
255401	PH0	0 x 3	60	141	40	12	8033116532341
255402	PH1	1 x 4,5	80	170	60	12	8033116532358
255403	PH1	1 x 4,5	100	195	70	12	8033116532716
255405	PH2	2 x 6	100	207	115	12	8033116532129
255408	PH3	3 x 8	150	275	205	12	8033183551351









255403L GIRAVITI PER MECCANICI TIPO LUNGO LONG MECHANIC SCREWDRIVERS

Per viti con impronta a croce "Phillips" / For Phillips screws

Codice		PH x B mm	C mm	D mm	gr		Barcode
255403L	PH1	1 x 4,5	250	350	220	12	8033183587046
255405L	PH2	2 x 6	250	350	260	12	8033183587053



104101 - 104102 SERIE GIRAVITI PER MECCANICI MECHANIC SCREWDRIVERS SET

Codice	Pezzi / pieces			Barcode
104101	5	1 x 255001 - 255003 - 255009 1 x 255403 - 255405	 	5 8033116534314
104102	7	1 x 255001 - 255003 - 255006 - 255009 1 x 255402 - 255405 1 x 255203	  	5 8033116534321







255523 GIRAVITI PER MECCANICI MECHANIC SCREWDRIVERS

Per viti con impronta a croce "Pozidriv" / For Pozidriv screws

Codice		PZ x B mm	C mm	D mm	gr		Barcode
255523	PZ0	0 x 3	60	140	40	12	8033183552730
255520	PZ1	1 x 4,5	80	170	60	12	8033116533751
255521	PZ2	2 x 6	100	207	115	12	8033116533768
255522	PZ3	3 x 8	150	275	205	12	8033116533775



255601 - 255701 GIRAVITI PER MECCANICI TIPO NANO MINI MECHANIC SCREWDRIVERS

Codice		PH/A x B mm	C mm	D mm	gr		Barcode
255601		0,6 x 4	30	80	30	12	8033116532235
255603		1 x 6	40	90	35	12	8033116533782
255701		1 x 4,5	30	80	32	12	8033116532211
255703		2 x 6	40	90	35	12	8033116532228



2565F06 GIRAVITI PER MECCANICI MECHANIC SCREWDRIVERS

Per viti con impronta a croce "Torx" con foro
for Torx screws with hole



Codice	TX	c mm	D mm	gr	📦	Barcode
2565F06	TX 6	60	130	35	12	8033183569226
2565F07	TX 7	60	130	35	12	8033183569233
2565F08	TX 8	60	130	35	12	8033183568410
2565F09	TX 9	70	140	40	12	8033183569240
2565F10	TX 10	85	155	40	12	8033116533911
2565F15	TX 15	95	165	40	12	8033116533928
2565F20	TX 20	120	190	65	12	8033116533935
2565F25	TX 25	120	190	70	12	8033116533942
2565F27	TX 27	135	205	75	12	8033116533959
2565F30	TX 30	155	225	120	12	8033116533966
2565F40	TX 40	170	240	130	12	8033116533973
2565F45	TX 45	180	250	210	12	8033183569257

257502V ESPOSITORE 60 GIRAVITI PER MECCANICI EXHIBITOR 60 MECHANIC SCREWDRIVERS



Codice		📦	Barcode
257502V	10 x 255201 - 255204	⊖	1 8033183590220
	10 x 255004 - 255006	⊖	
	10 x 255521	⊕	
	10 x 255402	⊕	

257506 ESPOSITORE 168 GIRAVITI PER MECCANICI EXHIBITOR 168 MECHANIC SCREWDRIVERS



Codice		📦	Barcode
257506	12 x 255001 - 03 - 06 - 09 - 12	⊖	1 8033116534536
	12 x 255201 - 03 - 07	⊖	
	12 x 255401 - 02 - 05 - 08	⊕	
	12 x 255601	⊖	
	12 x 255701	⊕	

104201 - 104202 - 104203 SERIE GIRAVITI PER MECCANICI MECHANIC SCREWDRIVERS SET



- ◆ Acciaio al cromo molibdeno
Chromium-molybdenum alloy steel
- ◆ Lame temperate a induzione con durezza 58-61 HRC
Induction hardened blades with hardness 58-61 HRC
- ◆ Impugnatura anatomica bicomponente con protezione antiscivolo
Bi-component anatomic non-slip grip
- ◆ Punta magnetica per facilitare il lavoro
Magnetic tip for easier work



Codice	Pezzi / Pieces		📦	Barcode
104201	5	1 x 245303 - 245306 - 245313	⊖	5 8033183555403
		1 x 245413 - 245415	⊕	
104202	7	1 x 245303 - 245306 - 245310 - 245313	⊖	5 8033183555410
		1 x 245412 - 245413 - 245415	⊕	
		1 x 245303 - 245306 - 245308	⊖	
104203	6	1 x 245412 - 245413 - 245415	⊕	5 8033183556233
			⊖	

244700N GIRAVITI PER MICRO - ELETTRONICA
 MICRO ELECTRIC SCREWDRIVER

Per viti con testa ad intaglio / For slotted screws

- Lame cromate con punte brunate per prevenire la corrosione
 Chrome blades with burnished tips to prevent corrosion
- Impugnatura ergonomica con protezione in gomma antiscivolo
 Ergonomic handle with non-slip rubber protection

Codice	A x B mm	C mm	D mm	gr		Barcode
244700N	0,2 x 1,5	50	148	45	12	8033116533980
244701N	0,3 x 1	50	148	65	12	8033183562302
244702N	0,4 x 2,5	50	148	80	12	8033116533997
244703N	0,5 x 3	50	148	130	12	8033116534000
244705N	0,5 x 3,5	50	148	235	12	8033116534024

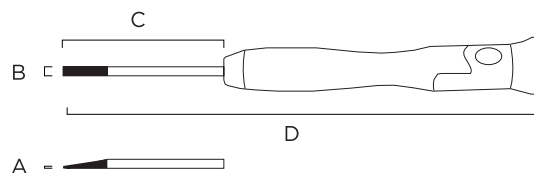

2448P000 GIRAVITI PER MICRO - ELETTRONICA
 MICRO ELECTRIC SCREWDRIVER

Per viti con impronta a croce "phillips" / For Phillips screws

- Lame cromate con punte brunate per prevenire la corrosione
 Chrome blades with burnished tips to prevent corrosion
- Impugnatura ergonomica con protezione in gomma antiscivolo
 Ergonomic handle with non-slip rubber protection

Codice	A x B mm	C mm	D mm	gr		Barcode
2448P000	0,2 x 1,5	50	148	45	12	8033183551894
2448P00	0,3 x 1	50	148	65	12	8033183551900
2448P0	0,4 x 2,5	50	148	80	12	8033116534062
2448P1	0,5 x 3	50	148	130	12	8033116534079



244901 ESPOSITORE GIRAVITI PER MICRO - ELETTRONICA
 EXHIBITOR MICRO ELECTRIC SCREWDRIVER

Codice		Barcode
244901	6 x 244700N - 244701N - 244702N 244703N - 244705N	8033116534116
	6 x 2448P00 - 2448P0 - 2448P1	



244901 ESPOSITORE GIRAVITI PER MICRO - ELETTRONICA
 SET OF 6 MICRO ELECTRIC SCREWDRIVER

Lama in acciaio al cromo e manico in plastica TRP nera
 Chrome-plated blade - black trp plastic



Codice	Pezzi / Pieces		Barcode
242101	6	12	8033116534390
			1 x 1,4 - 2,0 - 2 - 4 1 x PH00 - PH0 - PH1
242101E	12	1	8033183557605
			Espositore / Set: 242101

255400 GIRAVITI DOPPIO USO
DOUBLE USE SCREWDRIVERS

Per viti con testa ad intaglio + croce / For slotted + cross-head screws

Codice	Pezzi / pieces		mm	gr		Barcode
255400			210	97	12	8033183552099
255400B	12	Espositore / Set			1	8033183552129



255000 GIRAVITI DOPPIO USO TIPO NANO
MINI DOUBLE USE SCREWDRIVERS

Per viti con testa ad intaglio + croce / For slotted + cross-head screws

Codice	Pezzi / pieces		mm	gr		Barcode
255000			100	57	12	8033183552112
255000B	12	Espositore / Set			1	8033183551931



Giraviti cercafase
Phase finder screwdrivers

- 1** Lampadina al neon interna al manico con resistenza elettrica ad alto valore + molla di collegamento.
Neon bulb inside the handle with electric resistance high value + connecting spring.

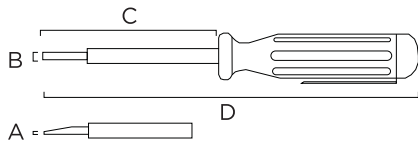

244211 CERCAFASE BICOMPONENTE TASCABILE
POCKET PHASE FINDER BI-COMPONENT SCREWDRIVERS

- Impugnatura in bicomponente con clip di aggancio
Bi-component handle with hooking clip
- Rileva la presenza di tensione elettrica: 220V - 250V
It detects the presence of electrical voltage: 220V - 250V

Codice	A x B mm	C mm	D mm	gr		Barcode
244211	0,5 x 3	64	140	30	12	8033153568489



244212 CERCAFASE BICOMPONENTE
PHASE FINDER BI-COMPONENT SCREWDRIVERS

- Impugnatura in bicomponente con clip di aggancio
Bi-component handle with hooking clip
- Rileva la presenza di tensione elettrica: 220V - 250V
It detects the presence of electrical voltage: 220V - 250V

Codice	A x B mm	C mm	D mm	gr		Barcode
244212	0,5 x 33	94	180	40	12	8033183569219



244001 CERCAFASE TASCABILE
POCKET PHASE FINDER SCREWDRIVERS

- Impugnatura in plastica trasparente isolante con clip di aggancio
Transparent plastic insulated handle with hooking clip
- Rileva la presenza di tensione elettrica: 220V - 250V
It detects the presence of electrical voltage: 220V - 250V



Codice	A x B mm	C mm	D mm	gr		Barcode
244001	0,5 x 3	60	140	12	12	8033116534123



244201 CERCAFASE
PHASE FINDER SCREWDRIVERS

- Impugnatura in plastica trasparente isolante con clip di aggancio
Transparent plastic insulated handle with hooking clip
- Rileva la presenza di tensione elettrica: 220V - 250V
It detects the presence of electrical voltage: 220V - 250V



Codice	A x B mm	C mm	D mm	gr		Barcode
244201	0,8 x 4	95	190	35	12	8033116534130



244010 CERCAFASE TONDO
ROUND PHASE FINDER SCREWDRIVERS

- Impugnatura ABS con paramano e clip di aggancio
ABS handle with hand guard and hooking clip
- Rileva la presenza di tensione elettrica: 150V - 250V
It detects the presence of electrical voltage: 150V - 250V



Codice	A x B mm	C mm	D mm	gr		Barcode
244010	0,5 x 3	55	140	30	12	8033116534147



244210 CERCAFASE SQUADRATO
SQUARE BODY PHASE FINDER SCREWDRIVERS

- Impugnatura ABS con paramano e clip di aggancio
ABS handle with hand guard and hooking clip
- Rileva la presenza di tensione elettrica: 150V - 250V
It detects the presence of electrical voltage: 150V - 250V



Codice	A x B mm	C mm	D mm	gr		Barcode
244210	0,8 x 4	105	190	34	12	8033116531146



Giraviti 1000V

1000V screwdrivers

La finitura nera conserva l'integrità della punta evitando i fenomeni dell'ossidazione

The black finish preserves the integrity of the tip

Isolamento protettivo secondo le norme ISO per lavorare in modo sicuro su impianti elettrici con tensione fino a 1000 volt

Protective insulation according to ISO standard to work in a security way on electrical systems

Impugnatura anatomica tricomponente antiscivolo con fermo poggiadito garantisce un elevato comfort in caso di utilizzo prolungato

Three-component anatomic grip non-slip with finger rest

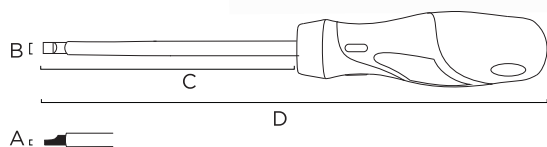

045020 GIRAVITI PROFESSIONALI PER ELETTRICISTI 1000V
PROFESSIONAL 1000V SCREWDRIVERS
Per viti con testa ad intaglio / For slotted screws

Codice	A x B mm	C mm	D mm	gr		Barcode
045020	0,5 x 3	100	185	45	12	8033183834539
045021	0,8 x 4	125	185	65	12	8033183834546
045022	1 x 5,5	125	225	80	12	8033183834553
045024	1,2 x 6,5	150	260	143	12	8033183834560
045026	1,2 x 8	175	280	150	12	8033183834577



045420 GIRAVITI PROFESSIONALI PER ELETTRICISTI 1000V
PROFESSIONAL 1000V SCREWDRIVERS
Per viti con impronta a croce "Phillips" / For Phillips screws

Codice	PH x B mm	C mm	D mm	gr		Barcode	
045420	PH0	0 x 3	60	145	40	12	8033116533270
045421	PH1	1 x 4,5	80	180	60	12	8033116531139
045422	PH2	2 x 6	100	210	115	12	8033116533287
045423	PH3	3 x 8	150	270	210	12	8033183551399



045520 GIRAVITI PROFESSIONALI PER ELETTRICISTI 1000V
PROFESSIONAL 1000V SCREWDRIVERS
Per viti con impronta a croce "Pozidriv" / For Pozidriv screws

Codice	PZ x B mm	C mm	D mm	gr		Barcode	
045520	PZ0	1 x 3	60	145	40	12	8033116533324
045521	PZ1	2 x 4,5	80	180	60	12	8033116533331
045522	PZ2	3 x 6	100	210	115	12	8033116530132
045523	PZ3	4 x 8	150	270	210	12	8033116530149



1045027 - 045028 SERIE GIRAVITI PROFESSIONALI 1000V
PROFESSIONAL 1000V SCREWDRIVERS SET

Codice	Pezzi / pieces		Barcode	
045027	5	1 x 045020 - 045021 - 045022	1	8033183836236
		1 x 045420 - 045421		
045028	6	1 x 045020 - 045021 - 045022	1	8033183839183
		1 x 045420 - 045421 - 045422		



045029 ESPOSITORE 92 GIRAVITI PROFESSIONALI 1000V
EXHIBITOR 92 PROFESSIONAL 1000V SCREWDRIVERS

Codice			Barcode
045029	8 x 045020 - 045021 - 045022	1	8033183843050
	6 x 045026 - 045024		
	8 x 045420 - 045421		
	8 x 045422 - 045423		
	8 x 045520 - 045521		
	6 x 045522 - 045523		



Isolamento protettivo secondo le norme ISO
per lavorare in modo sicuro su impianti elettrici con
tensione fino a 1000 volt

*Protective insulation according to ISO standard to work
in a security way on electrical systems*



**Lama in acciaio al cromo
vanadio molibdeno con finitura nera**

*Chrome steel blade molybdenum
vanadium with black finish*

Protezione antiscivolo
Non-slip protection

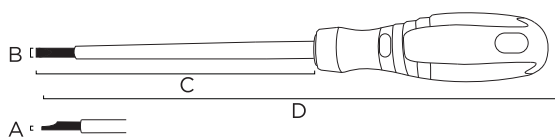

053001 GIRAVITI PER ELETTRICISTI 1000V
1000V SCREWDRIVERS

Per viti con testa ad intaglio / For slotted screws

Codice	A x B mm	C mm	D mm	gr		Barcode
053001	0,6 x 2,5	80	154	23	12	8033116531726
053002	0,8 x 3	100	174	25	12	8033116537018
053003	1,2 x 4	100	192	24	12	8033116537025
053004	1,6 x 5,5	125	217	50	12	8033116531702
053005	1,6 x 6,5	150	260	74	12	8033116537032
053006	1,8 x 8	175	293	161	12	8033116537049



045001 GIRAVITI PER ELETTRICISTI 1000V
1000V SCREWDRIVERS

Per viti con impronta a croce "Phillips" / For Phillips screws

Codice	PH X B mm	C mm	D mm	gr		Barcode	
054001	PH0	0 x 3	75	149	24	12	8033116537063
054002	PH1	1 x 5	100	192	34	12	8033116537070
054003	PH2	2 x 6	100	210	74	12	8033116537087
054004	PH3	3 x 8	150	268	161	12	8033116537094





054501 GIRAVITI PER ELETTRICISTI 1000V
1000V SCREWDRIVERS

Per viti con impronta a croce "Pozidriv" / For Pozidriv screws

Codice	PH X B mm	C mm	D mm	gr		Barcode	
054501	PZ0	0 x 3	75	149	24	12	8033116537100
054502	PZ1	1 x 5	100	192	34	12	8033116537117
054503	PZ2	2 x 6	100	210	74	12	8033116537124
054504	PZ3	3 x 8	150	268	161	12	8033116537131



094025 SERIE GIRAVITI PER ELETTRICISTI 1000V
1000V SCREWDRIVERS SET

Codice	Pezzi / pieces			Barcode	
094025	6	1 x 053001 - 053002 - 053003	 	5	8033116537940
		1 x 054001 - 054002 - 054003			

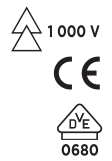

MASSIMA RESA MINIMO SFORZO

MAXIMUM YIELD WITH
MINIMUM EFFORT

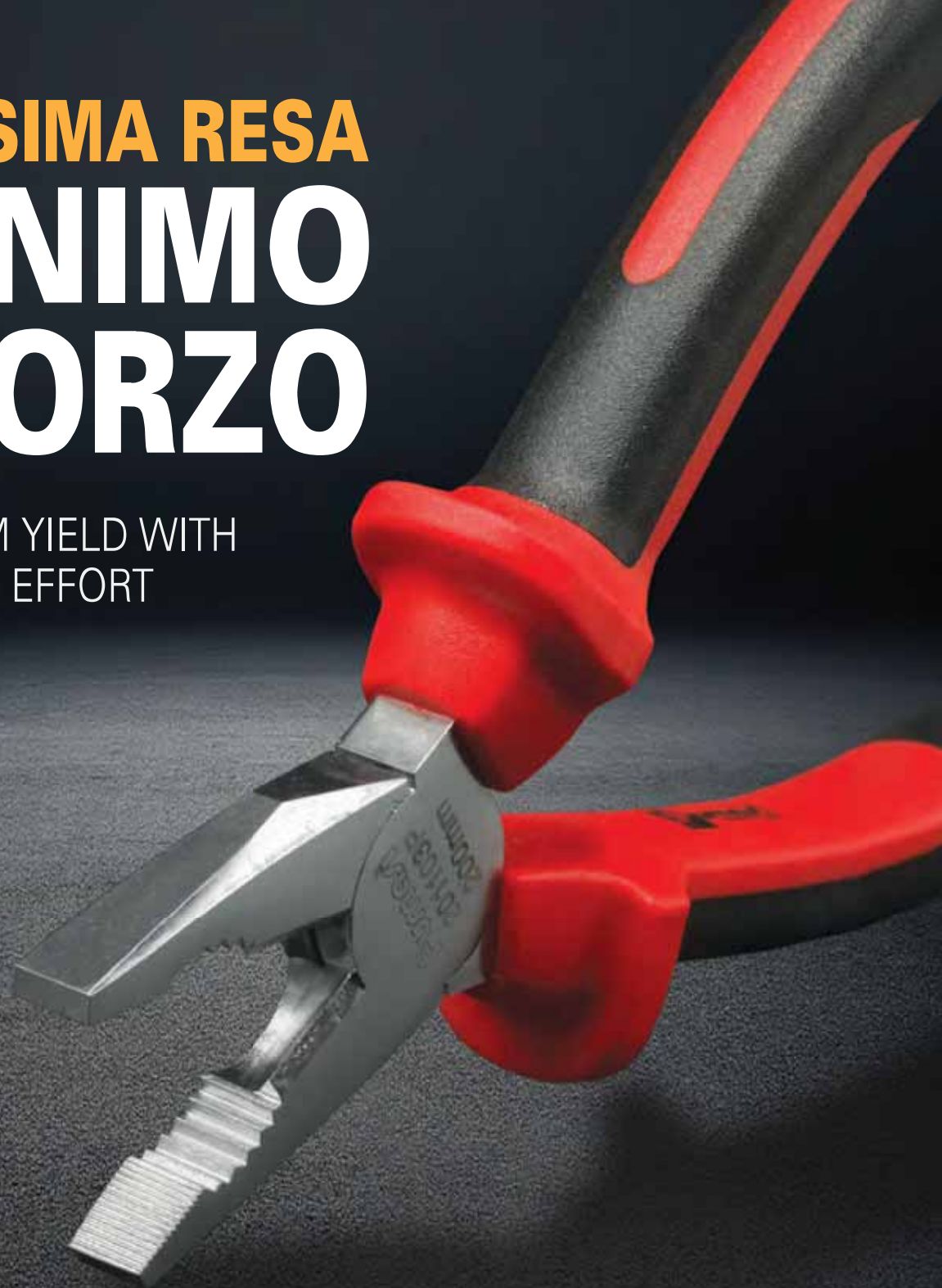

LINEA PRO
PRO LINE



ISOLATO PER TENSIONE 1000V
INSULATED FOR 1000V VOLTAGE



CONFORME AGLI STANDARD EUROPEI
COMPLIES WITH EUROPEAN STANDARDSMENTS



CONFORME ALLE NORME DVE
COMPLIES WITH DVE STANDARDS



PINZA PER ANELLI ESTERNI
PLIER FOR EXTERNAL RINGS



PINZA PER ANELLI INTERNI
PLIER FOR INTERNAL RINGS



FILO DI MEDIA RESISTENZA
MEDIUM RESISTANCE WIRE



FILO AD ALTA RESISTENZA
HIGH RESISTANCE WIRE

- 54 Pinze universali
Universal pliers
- 58 Sezione 1000 VOLT
1000 VOLT section
- 65 Pinze di precisione
Precision pliers
- 69 Pinze regolabili
Adjustable pliers
- 73 Pinze rivettatrici
Riveting pliers

Pinze universali

Universal pliers

► Linea PRO

PRO line

Le pinze della linea PRO sono la sintesi di un perfetto connubio tra la qualità dei materiali maneggevoli, utilizzati nell'impugnatura e nella testa, e la praticità delle forme snelle e comode, che si adattano a qualsiasi tipo di lavoro.

The PRO line pliers are the synthesis of a perfect combination of the quality of the manageable materials, used in the handle and head, and the practicality of the slim and comfortable shapes, which adapt to any type of work.



- 1** **Struttura in acciaio al Cromo Vanadio che permette una maggior durata della pinza nel tempo.**
Chrome Vanadium steel structure that allows a longer life of the pliers over time.
- 2** **Tagliante a induzione in acciaio temperato e AFFILATO A MANO.**
Induction cutting edge in hardened steel and HAND SHARPENED.
- 3** **Impugnatura spessa in bicomponente per un massimo comfort; Maniglie ergonomiche con protezioni per le dita.**
Thick two-component handle for maximum comfort; Ergonomic handles with finger guards.

201102P PINZE UNIVERSALI PROFESSIONALI PROFESSIONAL UNIVERSAL PLIERS

- Consentono di tagliare fili duri applicando il minimo sforzo
Allows you to cut hard wires with minimal effort
- Le ganasce seghettate migliorano la presa
Serrated jaws improve grip

Codice	mm	gr		Barcode
201101P	160	214	6	8033183586414
201102P	180	273	6	8033183586421
201103P	200	351	6	8033183586438



Fumori
PRO

208102P TRONCHESE UNIVERSALE PROFESSIONALE PROFESSIONAL UNIVERSAL CUTTERS

- Tagliente su tutta la lama, realizzato con il miglior acciaio per resistente al taglio di materiali duri
Cutting edge on the whole blade made with the best steel resistant in cutting hard materials

Codice	mm	gr		Barcode
208101P	140	150	6	8033183586445
208102P	160	214	6	8033183586452



Fumori
PRO

207201P PINZE PROFESSIONALI BECCHI LUNGHI LONG NOSE PROFESSIONAL PLIERS

- Punta zigrinata per una migliore presa anche su pezzi molto piccoli
Knurled tips for a better grip even on very small pieces
- Per lavori di presa e taglio nella meccanica di precisione
For gripping and cutting work in precision mechanics
- Consentono di realizzare opere raffinate e tagliare fili di ferro
It allows you to create refined works and cut iron wires

Codice	mm	gr		Barcode
207201P	160	240	6	8033183586469
207202P	200	360	6	8033183586476



Fumori
PRO

207401P PINZE PROFESSIONALI BECCHI LUNGHI PIEGATI LONG BENT NOSE PROFESSIONAL PLIERS

- Becchi mezzitondi angolati a 40°
Half-round jaws angled at 40°
- Punta zigrinata per una migliore presa anche su pezzi molto piccoli
Knurled tips for a better grip even on very small pieces
- Per lavori di presa e taglio nella meccanica di precisione
For gripping and cutting work in precision mechanics
- Consentono di tagliare fili duri applicando il minimo sforzo
Allows you to cut hard wires with minimal effort

Codice	mm	gr		Barcode
207401P	160	240	6	8033183586483
207402P	200	360	6	8033183586490



Fumori
PRO

► Linea classica

Classic line

Le classiche che non deludono mai!
Modello leggero, particolarmente indicate per
usi comuni come lavori di manutenzione.

*The classics that never disappoint!
Lightweight model, particularly suitable for
common uses such as maintenance work.*



- 1** **Struttura in acciaio con superficie cromata.**
Steel structure with chromed surface.
- 2** **Impugnatura in PVC bicolore con superficie antiscivo e protezioni per le dita.**
Bi-color PVC handle with non-slip surface and finger guards.

201101 PINZE UNIVERSALI UNIVERSAL PLIERS

- ♦ Consentono di tagliare fili duri applicando il minimo sforzo
Allows you to cut hard wires with minimal effort
- ♦ Le ganasce seghettate migliorano la presa
Serrated jaws improve grip

Codice	mm	gr		Barcode
201101	160	230	6	8033116532136
201102	180	310	6	8033116531177
201103	200	400	6	8033116531641



208101 TRONCHESE UNIVERSALE UNIVERSAL CUTTERS

- ♦ Tagliente su tutta la lama, realizzato con il miglior acciaio
per resistente al taglio di materiali duri
*Cutting edge on the whole blade made with the best steel
resistant in cutting hard materials*

Codice	mm	gr		Barcode
208101	140	165	6	8033116535793
208102	160	225	6	8033116532280



207201 PINZE BECCHI LUNGHI LONG NOSE PLIERS

- ♦ **Punte zigrinate per una migliore presa anche su pezzi molto piccoli**
Knurled tips for a better grip even on very small pieces
- ♦ **Per lavori di presa e taglio nella meccanica di precisione**
For gripping and cutting work in precision mechanics
- ♦ **Consentono di realizzare opere raffinate e tagliare fili di ferro**
It allows you to create refined works and cut iron wires



Codice	mm	gr		Barcode
207201	160	180	6	8033116535113
207202	200	200	6	8033116535120

207401 PINZE BECCHI LUNGHI PIEGATI LONG BENT NOSE PLIERS

- ♦ **Becchi mezzitondi angolati a 40°**
Half-round jaws angled at 40 °
- ♦ **Punte zigrinate per una migliore presa anche su pezzi molto piccoli**
Knurled tips for a better grip even on very small pieces
- ♦ **Per lavori di presa e taglio nella meccanica di precisione**
For gripping and cutting work in precision mechanics
- ♦ **Consentono di tagliare fili duri applicando il minimo sforzo**
Allows you to cut hard wires with minimal effort



Codice	mm	gr		Barcode
207401	160	180	6	8033116535144
207402	200	200	6	8033116535151

Pinze 1000V

1000V pliers



- 1** **Struttura in acciaio al Cromo Molibdeno con finitura satinata.**
Structure in chromium molybdenum steel with satin finish.
- 2** **Lame con fresatura interna super affilata e tagliente a induzione ad alta resistenza.**
Super sharp internal milling blades and high strength induction cutting edge.
- 3** **Impugnatura spessa in bicomponente, antiscivolo, morbida e confortevole, testata e garantita 1000 Volt.**
La maniglia vede la presenza del paramano per garantire la massima sicurezza durante l'uso.
Thick bi-component handle, non-slip, soft and comfortable, tested and guaranteed 1000 Volt.
The handle sees the presence of the handle to ensure maximum safety during use.

001101 PINZE UNIVERSALI PROFESSIONALI 1000V

PROFESSIONAL UNIVERSAL PLIERS 1000V

- ♦ Consentono di tagliare fili duri applicando il minimo sforzo
Allows you to cut hard wires with minimal effort
- ♦ Le ganasce seghettate migliorano la presa
Serrated jaws improve grip

Codice	mm	gr	📦	Barcode
001101	160	215	6	8033116531412
001102	180	260	6	8033116531405
001103	200	375	6	8033116531429



003301 PINZE BECCHI LUNGI 1000V

1000V LONG NOSE PLIERS

- ♦ Punta zigrinata per una migliore presa anche su pezzi molto piccoli
Knurled tips for a better grip even on very small pieces
- ♦ Per lavori di presa e taglio nella meccanica di precisione
For gripping and cutting work in precision mechanics
- ♦ Consentono di realizzare opere raffinate e tagliare fili di ferro
It allows you to create refined works and cut iron wires

Codice	mm	gr	📦	Barcode
003301	160	185	6	8033116531474
003302	200	290	6	8033116531481



003201 PINZE BECCHI LUNGI PIEGATI 1000V
1000V LONG BENT NOSE PLIERS

- Becchi mezzitondi angolati a 40°
Half-round jaws angled at 40°
- Punte zigrinate per una migliore presa anche su pezzi molto piccoli
Knurled tips for a better grip even on very small pieces
- Per lavori di presa e taglio nella meccanica di precisione
For gripping and cutting work in precision mechanics
- Consentono di tagliare fili duri applicando il minimo sforzo
Allows you to cut hard wires with minimal effort

Codice	mm	gr		Barcode
003201	160	185	6	8033116531450
003202	200	290	6	8033116531467



002011 PINZE BECCHI LUNGI PIATTI 1000V
1000V LONG FLAT NOSE PLIERS

- Punte zigrinate per una migliore presa anche su pezzi molto piccoli
Knurled tips for a better grip even on very small pieces
- Per lavori di presa e taglio nella meccanica di precisione
For gripping and cutting work in precision mechanics
- Consentono di tagliare fili duri applicando il minimo sforzo
Allows you to cut hard wires with minimal effort

Codice	mm	gr		Barcode
002011	160	200	6	8033116531436



002111 PINZE BECCHI LUNGI TONDI 1000V
1000V LONG ROUND NOSE PLIERS

- Impiegate nella curvatura degli occhielli
Used in the curvature of the eyelets

Codice	mm	gr		Barcode
002111	160	170	6	8033116531443



031001 PINZE SPELACAVI 1000V
1000V CABLE STRIPPER

- Registro a vite per regolazione a mano dello spessore
Screw register for manual thickness adjustment
- Per spelare fili da mm² 0,5÷6
To strip wires from 0.5 to 6 mm²

Codice	mm	gr		Barcode
031001	160	190	6	8033116531559



021101 TAGLIACAVI 1000V 1000V CABLE CUTTERS

- Testa di lavoro ovale di forma compatta
Compact oval work head
- 2 Scanalature per cavi sottili e spessi
2 Grooves for thin and thick cables
- Adatto per cavi in alluminio e rame
Suitable for aluminum and copper cables

Codice	mm	gr		Barcode
021101	160	180	6	8033116531528
021102	200	300	6	8033116531535



021103 TAGLIACAVI CON DOPPIO TAGLIENTE 1000V 1000V CABLE CUTTERS WITH DOUBLE EDGE

- Sforzo minimo grazie all'ottimo rapporto di trasmissione e alla geometria speciale dei taglienti
Minimum effort thanks to the excellent transmission ratio and geometry special of the cutting edges
- Affilatura di precisione offre un taglio uniforme e non appiattisce il filo
Precision sharpening offers an even cut and does not flatten the line
- Tagliente dotato di due onde di taglio per lavorare con cavi di diversi diametri contemporaneamente
Cutting edge equipped with two cutting waves to work with different cables diameters at the same time

Codice	cavi Ø mm	mm	gr		Barcode
021103	fino a 25	200	320	6	8033116531542



016102 TRONCHESE LATERALE 1000V 1000V SIDE CUTTER

- Testa stretta per l'impiego in luoghi di difficile accesso
Narrow head to use in places difficult to access
- Taglienti di precisione per filo metallico a bassa e alta resistenza
Precision cutting edges for low and high strength wire
- Taglio pulito sulle punte dei taglienti
Clean cut at the tips of the cutting edges

Codice	mm	gr		Barcode
016102	160	141	6	8033116531511



011101 TRONCHESE LATERALE 1000V 1000V SIDE CUTTER

- Esecuzione bonderizzata nera
Black bonded execution
- Elevata capacità di carico a lunga durata senza sforzo
High load capacity long life without effort
- Ideale per tutti i tipi di filo metallico incluso filo armonico
Ideal for all types of metal wire including harmonic wire

Codice	mm	gr		Barcode
011101	180	255	6	8033116531498
011102	200	290	6	8033116531504



016103 TRONCHESE LATERALE 1000V
1000V SIDE CUTTER

- Profilo della lama studiato per migliorare la qualità di taglio
Blade profile designed to improve cutting quality
- Spellatura per conduttori a uno o più fili con 1,5 mm² e 2,5 mm²
Stripping for single and multi-core conductors with 1.5 mm² and 2.5 mm²
- 4 funzioni: tagliare, spellare, pressare, piegare
4 functions: cutting, stripping, pressing, folding

Codice	mm	gr		Barcode
016103	190	290	6	8033116531399



032101 PINZE REGOLABILI A CERNIERA CHIUSA 1000V
1000V CLOSED HINGE ADJUSTABLE CLAMP

- Pinze regolabili tramite pressione diretta sul pezzo
Adjustable gripper by direct pressure on the piece
- 7 posizioni di regolazione
7 adjustment positions
- Zigrinatura sulla lama per evitare scivolamento del pezzo
Knurling on the blade to avoid slipping of the piece

Codice	Ø tubi mm	mm	gr		Barcode
032101	50	160	190	6	8033116531566



033001 PINZE PRENSILI 1000V
1000V GRIPPER

- Pinze in resina sintetica a forte spessore
Strong thickness synthetic resin pliers
- Isolamento completo per evitare cortocircuiti
Full insulation to avoid short circuits
- Per il montaggio e la sigillatura dei contatori
For mounting and sealing of meters

Codice	mm	gr		Barcode
033001	200	75	6	8033116536899



093202 ESPOSITORE 12 UTENSILI 1000V
SET OF 12 1000V TOOLS

Codice			Barcode
093202	12 x 001102	1	8033183568557
093210	6 x 001102; 6 x 003301	1	8033183568564
093220	6 x 001102; 6 x 016102	1	803318356871
093201	4 x 021102; 4 x 031001; 4 x 003201	1	803318537933



Set di utensili 1000V

1000V tool set

► Per specifiche sui portautensili vedi pag. 286 "BORSE E CONTENITORI"
For specifics on tool holders see p. 286 "BAGS AND CONTAINERS"

100001 ASSORTIMENTO 14 UTENSILI 1000V

ASSORTMENT OF 14 1000V TOOLS

- ♦ **Pinze isolate:** Pinza universale: cod. 001102
Pinza becchi lunghi mezzitondi: cod. 003202
Pinza becchi lunghi mezzi, piegati: cod. 003302
Pinza becchi lunghi piatti: cod. 002011
Pinza spelacavi: cod. 031001
Insulated pliers: 001102 - 003202 - 003302 - 002011 - 031001
- ♦ **Tronchese laterale isolato:** cod. 016102
Insulated side cutter: cod. 016102
- ♦ **Giraviti a intaglio isolati:** cod. 045020; 045021; 045022; 045024 ⚡
Insulated slotted screwdrivers: cod. 045020; 045021; 045022; 045024
- ♦ **Giraviti a croce PH isolati:** cod. 045420; 045421; 045422 ⚡
PH insulated cross screwdrivers: cod. 045420; 045421; 045422
- ♦ **Mazzuola con tasselli:** cod. 150001
Mallet with dowels: cod. 150001

Borsa in tessuto tecnico: cod. 100425
Technical fabric bag: cod. 100425



Codice	Quantità	Barcode
100001	1	8033116538015

100003 ASSORTIMENTO 12 UTENSILI 1000V

ASSORTMENT OF 12 1000V TOOLS

- ♦ **Pinze isolate:** Pinza universale: cod. 001102
Pinza becchi lunghi mezzitondi: cod. 003201
*Insulated pliers: Universal pliers: cod. 001102
Long half-round nose pliers: cod. 003201*
- ♦ **Tronchese laterale isolato:** cod. 016102
Insulated side cutter: cod. 016102
- ♦ **Chiave a rullino isolata:** cod. 039001
Insulated roller wrench: cod. 039001
- ♦ **Chiave a forchetta isolata:** cod. 080517
Insulated open-end wrench: cod. 080517
- ♦ **Coltello lama dritta isolato:** cod. 033501
Insulated straight blade knife: cod. 033501
- ♦ **Impugnatura porta inserti 1/4":** cod. 076001
1/4" bit holder handle: cod. 076001
- ♦ **Giraviti a intaglio isolati:** cod. 045020; 045021; 045022; ⚡
Insulated slotted screwdrivers: cod. 045020; 045021; 045022;
- ♦ **Giraviti a croce PH isolati:** cod. 045422; 045423 ⚡
PH insulated cross screwdrivers: cod. 045422; 045423

Borsa in tessuto tecnico: cod. 100424
Technical fabric bag: cod. 100424



Codice	Quantità	Barcode
100003	1	8033183590381

100722E ASSORTIMENTO 14 UTENSILI 1000V
ASSORTMENT OF 14 1000V TOOLS



- **Pinze isolate:** Pinza universale: cod. 001102
Pinza becchi lunghi mezzitondi: cod. 003202
Pinza becchi lunghi mezzi, piegati: cod. 003302
Pinza becchi lunghi piatti: cod. 002011
Pinza spelacavi: cod. 031001
Insulated pliers: Universal pliers: cod. 001102
Long half-round nose pliers: cod. 003202
Medium long nose pliers, folded: cod. 003302
Long flat nose pliers: cod. 002011
Cable stripping pliers: cod. 031001
- **Tronchese laterale isolato:** cod. 016102
Insulated side cutter: cod. 016102
- **Giraviti a intaglio isolati:** cod. 045020; 045021; 045022; 045024 ●
Insulated slotted screwdrivers: cod. 045020; 045021; 045022; 045024
- **Giraviti a croce PH isolati:** cod. 045420; 045421; 045422 ◐
PH insulated cross screwdrivers: cod. 045420; 045421; 045422
- **Mazzuola antirimbalo:** cod. 150202
Anti-rebound mallet: cod. 150202



Valigia in alluminio: cod. 100722
Aluminum case: cod. 100722

Codice		Barcode
100722E	1	8033183568588

094080 ASSORTIMENTO 9 UTENSILI 1000V
ASSORTMENT OF 9 1000V TOOLS





- **Pinze universali isolate:** cod. 001102
Universal insulated pliers: cod. 001102
- **Tronchese laterale isolato:** cod. 016102
Insulated side cutter: cod. 016102
- **Giraviti a intaglio isolati:** cod. 045021; 045022 ●
Insulated slotted screwdrivers: cod. 045021; 045022
- **Giraviti a croce PH isolati:** cod. 045421; 045422 ◐
PH insulated cross screwdrivers: cod. 045421; 045422
- **Giravite cercafase tascabile:** cod. 244001
Pocket phase finder screwdriver: cod. 244001
- **Forbici professionali isolate:** cod. 230845
Professional insulated scissors: cod. 230845
- **Flessometro magnetico 5x19:** cod. 601007
Magnetic measuring tape 5x19: cod. 601007

Tasca tessuto tecnico completa di cintura per agganciare alla vita: cod. 100424C
Technical fabric pocket with belt to attach to the waist: cod. 100424C



Codice		Barcode
094080	1	8033183554000

094085 ASSORTIMENTO 11 UTENSILI 1000V ASSORTMENT OF 11 1000V TOOLS

- Pinze universali isolate: cod. 001102
Pinze becchi lunghi mezzitondi: cod. 003201
Universal insulated pliers: cod. 001102
Long half-round nose pliers: cod. 003201
- Tronchese laterale isolato: cod. 016102
Insulated side cutter: cod. 016102
- Giraviti a intaglio isolati: cod. 045021; 045022 
Insulated slotted screwdrivers: cod. 045021; 045022
- Giraviti a croce PH isolati: cod. 045421; 045422 
PH insulated cross screwdrivers: cod. 045421; 045422
- Giraviti a croce PZ isolati: cod. 045521 
Insulated PZ cross screwdrivers: cod. 045521
- Giravite cercafase tascabile: cod. 244001
Pocket phase finder screwdriver: cod. 244001
- Forbici professionali isolate: cod. 230845
Professional insulated scissors: cod. 230845
- Flessometro magnetico 5x19: cod. 601007
Magnetic measuring tape 5x19: cod. 601007



Borsa compact in tessuto completa di tracolla: cod. 100422
Compact fabric bag complete with shoulder strap: cod. 100422



03

Codice		Barcode
094085	1	8033183554192

045001 SET 4 UTENSILI 1000V SET OF 4 1000V TOOLS

- Pinze universali isolata: cod. 001101
Universal insulated pliers: cod. 001101
- Giravite a intaglio isolato: cod. 045021 
Insulated slotted screwdriver: cod. 045021
- Giravite a croce PH isolato: cod. 045421 
PH insulated cross screwdriver: cod. 045421
- Forbici professionali isolate: cod. 230845
Professional insulated scissors: cod. 230845

Busta in cordura con bottone a pressione: cod. 100450V
Cordura pouch with snap button: cod. 100450V



Codice		Barcode
045001	1	8033183551252

Pinze di precisione

Precision pliers

- 1 Impugnatura rivestita in morbida gomma** per migliorare l'attrito con la mano.
Handle covered in soft rubber to improve friction with the hand.
- 2 Due tensioni a molla** che permettono di applicare una corretta pressione sull'oggetto lavorato.
Two spring tensions that allow you to apply correct pressure on the machined object.
- 3 L'acciaio ad alto tenore di carbonio C50** rende le pinze resistenti e robuste garantendone una lunga durata
C50 high carbon steel makes the pliers strong and sturdy ensuring a long life

991 TRONCHESE TAGLIO FRONTALE

FRONTAL CUT CUTTER

- ◆ Per tagliare fili di ferro o di rame
For cutting iron or copper wire

Codice	mm	gr		Barcode
991	95	60	12	8033183835413

992 TRONCHESE TAGLIO DIAGONALE

DIAGONAL CUT CUTTER

- ◆ Per tagliare fili di ferro o di rame
For cutting iron or copper wire

Codice	mm	gr		Barcode
992	105	60	12	8033183842893

993 PINZE BECCHI LUNGHI

LONG NOSE PLIER

- ◆ Impiegate per prese in punti difficili da raggiungere
Used for taking in hard-to-reach places

Codice	mm	gr		Barcode
993	120	60	12	8033183835437



994 PINZE BECCHI LUNGI PIEGATI
LONG FOLDED NOSE PLIER

- Impiegate per prese estreme in punti difficili da raggiungere
Used for extreme grips in hard to reach places

Codice	mm	gr		Barcode
994	120	60	12	8033183835444



995 PINZE BECCHI PIATTE
FLAT NOSE PLIER

- Per sorreggere o creare
To support or create

Codice	mm	gr		Barcode
995	120	60	12	8033183835451



996 PINZE BECCHI TONDI
ROUND NOSE PLIER

- Ganasce arrotondate che diventano gradualmente più sottili
Rounded jaws that gradually become thinner

Codice	mm	gr		Barcode
996	120	60	12	8033183835468



207502 PINZE PER AGHI
NEEDLES PLIER

- Becchi piatti con finitura liscia e nichelata
Smooth and nickel-plated finish flat jaws
- Becchi stretti che permettono un lavoro preciso
Narrow jaws that allow precise work
- Impugnatura ergonomica in plastica antiscivolo
Ergonomic non-slip plastic handle

Codice	mm	gr		Barcode
207502	180	200	6	8033183554079



221316 PINZE PER VETRAI
GLASS CLAMP

- Testa in acciaio speciale forgiato
Special forged steel head
- Becchi dritti bonderizzati
Bonderized straight nose
- Impugnatura rivestita in resina sintetica
Handle covered in synthetic resin

Codice	mm	gr		Barcode
221316	160	200	6	8033183553553
221320	200	310	6	8033183553560



1124N TRONCHESE PER ORAFI PIEGATO 30° CUTTERS FOR GOLDSMITHS 30 ° FOLDED



- Corpo in acciaio speciale altamente legato
Body in highly alloyed special steel
- Becchi arrotondati
Rounded beaks
- Tagliente diagonale a taglio raso
Diagonal cutting edge
- Manici rivestiti con guaina in PVC
Handles lined with PVC sheath

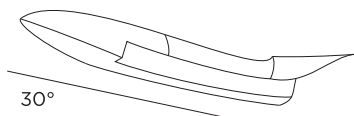

Codice	Capacità taglio oro / Gold cutting capacity Ø mm	mm	gr		Barcode
1124N	2,5	180	75	1	8033183568595

125801 TRONCHESE SGRAPPOLATORE PER ORAFI GRAPPLE CUTTER FOR GOLDSMITHS



- Testa lucida
Polished head
- Tagliente diagonale per fili d'oro
Diagonal cutting edge for gold threads
- Manici in lamiera d'acciaio temperati rivestiti con guaina in PVC
Tempered steel sheet handles coated with PVC sheath



Codice	Capacità taglio oro / Gold cutting capacity Ø mm	mm	gr		Barcode
125801	5	240	320	1	8033183568618

Pinze seeger Seeger pliers

153514 PINZE PER ANELLI SEEGER ESTERNI PLIERS FOR EXTERNAL RETAINING RINGS



- Corpo in acciaio legato con becchi conici bruniti
Alloy steel body with burnished conical jaws
- Becchi dritti per allargare anelli elastici Seeger
Straight jaws to widen Seeger elastic rings
- Impugnatura in PVC
PVC handle
- Con molla di richiamo
With return spring



Codice	Capacità /capacity mm	mm	gr		Barcode
1535T0	3 - 10	140	90	6	8033116535359
153514	10 - 25	140	90	6	8033116535205
153518	19 - 26	180	145	6	8033116534093
153522	40 - 100	225	235	6	8033116535212
153531	85 - 250	310	440	6	8033116535229





153613 PINZE PER ANELLI SEEGER ESTERNI PLIERS FOR EXTERNAL RETAINING RINGS

- Corpo in acciaio legato con becchi conici bruniti
Alloy steel body with burnished conical jaws
- Becchi piegati a 90°
Noses bent at 90°
- Impugnatura in PVC
PVC handle
- Con molla di richiamo
With return spring

Codice	Capacità /capacity mm	mm	gr		Barcode
1536T0	3 - 10	130	90	6	8033116535403
153613	10 - 25	130	90	6	8033116535236
153617	19 - 26	170	145	6	8033116535243
153621	40 - 100	219	235	6	8033116535250
153630	85 - 250	300	440	6	8033116535267



03

153714 PINZE PER ANELLI SEEGER INTERNI PLIERS FOR INTERNAL RETAINING RINGS

- Corpo in acciaio legato con becchi conici bruniti
Alloy steel body with burnished conical jaws
- Becchi dritti per allargare anelli elastici Seeger
Straight jaws to widen Seeger elastic rings
- Impugnatura in PVC
PVC handle
- Con molla di richiamo
With return spring

Codice	Capacità /capacity mm	mm	gr		Barcode
1537T0	8 - 25	140	90	6	8033116535458
153714	8 - 25	140	85	6	8033116535274
153718	19 - 26	180	145	6	8033116535281
153722	40 - 100	225	235	6	8033116535298
153731	85 - 250	310	415	6	8033116535304



153813 PINZE PER ANELLI SEEGER INTERNI PLIERS FOR INTERNAL RETAINING RINGS

- Corpo in acciaio legato con becchi conici bruniti
Alloy steel body with burnished conical jaws
- Becchi piegati a 90°
Noses bent at 90°
- Impugnatura in PVC
PVC handle
- Con molla di richiamo
With return spring

Codice	Capacità /capacity mm	mm	gr		Barcode
1538T0	8 - 25	130	85	6	8033116535502
153813	8 - 25	130	85	6	8033116535311
153817	19 - 26	170	145	6	8033116535328
153821	40 - 100	219	235	6	8033116535335
153830	85 - 250	300	415	6	8033116535342



Pinze regolabili

Adjustable pliers

167350 PINZE REGOLABILI A CERNIERA CHIUSA

CLOSED HINGE ADJUSTABLE CLAMPS



- ♦ Corpo in acciaio al cromo vanadio con finitura brunita
Chrome vanadium steel body with burnished finish
- ♦ Impugnatura rivestita in plastica
Plastic coated handle
- ♦ Regolazione a pulsante a 23 posizioni
Button adjustment with 23 positions
- ♦ Massima apertura becchi 38 mm
Maximum mouth opening 38 mm



Codice	Pezzi / Pieces	Min	Max	mm	gr	📦	Barcode
167350		1/8"	1" - 1/4"	180	190	6	8033116547789
167351		1/8"	1" - 5/8"	240	300	6	8033116547796
167352		1/8"	2"	300	530	6	8033116547802
167350E	12	Espositore / Exhibitor 12 x 167351				1	8033183562104
167351E	12	Espositore / Exhibitor 6 x 167350; 6 x 167351				1	8033183568755

167505 PINZE REGOLABILI A CERNIERA CHIUSA

CLOSED HINGE ADJUSTABLE CLAMPS



- ♦ Corpo in acciaio al cromo vanadio con finitura brunita
Chrome vanadium steel body with burnished finish
- ♦ Impugnatura rivestita in plastica
Plastic coated handle
- ♦ Massima apertura becchi 41 mm
Maximum mouth opening 41 mm



Codice	Pezzi / Pieces	mm	gr	📦	Barcode	
167504		175	155	6	8033183554826	
167505		250	330	6	8033116536080	
167506		300	530	6	8033183586643	
224645	12	Espositore / Exhibitor 12 x 167505			1	8033116536387

167200 PINZE REGOLABILI A CERNIERA CHIUSA

CLOSED HINGE ADJUSTABLE CLAMPS

- ♦ Corpo in acciaio completamente verniciato
Fully painted steel body



Codice	Pezzi / Pieces	mm	gr	📦	Barcode	
167200		175	174	6	8033116536059	
167201		240	310	6	8033116536066	
167202		300	550	6	8033116532624	
224204	25	Espositore / Exhibitor 5 x 167200 - 167202 15 x 167201			1	8033116536431

- 1** Ganasce in acciaio al cromo vanadio.
Jaws in chrome vanadium steel.
- 2** Impugnatura in lamiera di acciaio interamente cromata.
Fully chromed steel sheet handle.
- 3** Molla ad alta resistenza per ridurre la fatica durante il lavoro.
High strength spring to reduce fatigue during work.
- 4** Leva interna a scatto per la manovra di serraggio sul pezzo.
Internal snap lever for tightening on the piece.



Vite rotante per regolare le dimensioni dell'apertura
Rotating screw to adjust the size of the opening



163000 PINZE REGOLABILI AUTOBLOCCANTI SELF-LOCKING ADJUSTABLE PLIERS

- ♦ Ganasce simmetriche concave
Concave symmetrical jaws

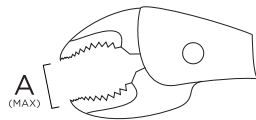

Codice	A (MAX) mm	mm	gr		Barcode
163000B	18	140	174	6	8033116535564
163000	28	170	370	6	8033116535571
163001	42	240	530	6	8033116535588
163002	65	300	860	6	8033116535595

163100 PINZE REGOLABILI AUTOBLOCCANTI GANASCE LUNGHE SELF-LOCKING ADJUSTABLE PLIERS LONG JAWS

- ♦ Ganasce simmetriche lunghe e sottili
Long and thin symmetrical jaws

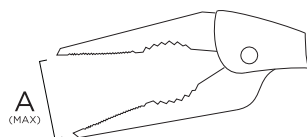

Codice	A (MAX) mm	mm	gr		Barcode
163100	25	170	189	6	8033116535601
163101	30	240	386	6	8033116535618

163201 PINZE REGOLABILI AUTOBLOCCANTI A SCATTO
ADJUSTABLE SELF-LOCKING SNAP CALIPER

- Ganasce simmetriche dritte
Straight symmetrical jaws

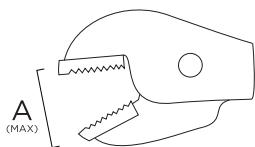

Codice	A (MAX) mm	mm	gr		Barcode
163201	30	240	492	6	8033116535625

163210 PINZE REGOLABILI AUTOBLOCCANTI GANASCIA SNODATA
ADJUSTABLE SELF-LOCKING GRIPPER ARTICULATED JAW

- Ganasce asimmetriche con parte inferiore snodata
Asymmetrical jaws with articulated lower part

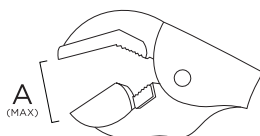

Codice	A (MAX) mm	mm	gr		Barcode
163210	60	240	530	6	8033116535632

163290 PINZE REGOLABILI AUTOBLOCCANTE A CATENA
ADJUSTABLE SELF-LOCKING CHAIN CALIPER

- Facilita la sostituzione del filtro dell'olio
Facilitates the replacement of the oil filter

Codice	Ø Serraggio / Clamping mm	mm	gr		Barcode
163290	25 - 160	240	700	2	8033116535649



163501 PINZE REGOLABILI AUTOBLOCCANTI SPECIALI
ADJUSTABLE SELF-LOCKING CHAIN CALIPER

- Ganasce piane a paletta
Flat paddle jaws
- Per il bloccaggio di particolari piani
For locking flat parts

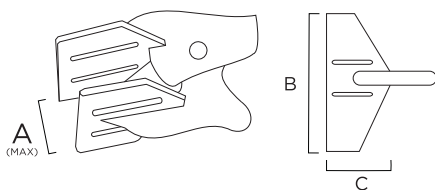

Codice	A (MAX) mm	B x C	mm	gr		Barcode
163501	25	80 x 45	280	730	2	8033183552587

163601 PINZE REGOLABILI AUTOBLOCCANTI SPECIALI
ADJUSTABLE SELF-LOCKING CHAIN CALIPER

- Ganasce a forcella per la saldatura di tubi
Fork jaws for pipe welding

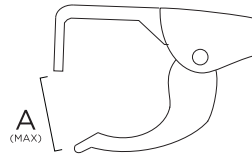

Codice	A (MAX) mm	mm	gr		Barcode
163601	75	280	730	2	8033116535663

163400 PINZE REGOLABILI AUTOBLOCCANTI A MORSETTO
ADJUSTABLE SELF-LOCKING CHAIN CALIPER

- Ganasce a collo di cigno
Gooseneck jaws

Codice	mm	gr		Barcode
163400	170	200	2	8033116531740
163401	240	650	2	8033116535656



163701 PINZE REGOLABILI AUTOBLOCCANTI A MORSETTO
ADJUSTABLE SELF-LOCKING CHAIN CALIPER

- Ganasce a collo di cigno
Gooseneck jaws
- Pattini girevoli per la presa di superfici irregolari
Revolving skids for gripping uneven surfaces

Codice	mm	gr		Barcode
163701	270	750	2	8033183552273



163801 PINZE REGOLABILI AUTOBLOCCANTI GANASCE LUNGHE
ADJUSTABLE SELF-LOCKING GRIPPER LONG JAWS

- Ganasce lunghe a collo di cigno
Long gooseneck jaws
- Per bloccaggi in profondità
For deep locking

Codice	mm	gr		Barcode
163801	460	1140	2	8033116535670
163802	600	1300	2	8033116535687



Pinze rivettatrici

Riveting pliers

165601 RIVETTATRICE MANUALE MANUAL RIVETER

- Corpo in alluminio
Aluminum body
- Impugnatura rivestita per una presa salda, completa di paramano
Covered handle for a firm grip complete with handguard
- Per rivetti da 2,4 a 4,8 mm (4,8 solo in alluminio)
For rivets from 2.4 to 4.8 mm (4.8 only in aluminum)
- Con molla di ritorno
With return spring
- Completa di 4 testine
With 4 heads



Codice	Ø mm				mm	gr		Barcode	
165601					260	510	1	8033183557568	
		Alluminio / Alluminium	Acciaio / Steel	Rame / Copper					Inox
	2,4	•		•					
	3-3,2	•	•	•					•
	4	•	•	•					
4,8	•								

165602 RIVETTATRICE MANUALE MANUAL RIVETER

- Corpo in alluminio
Aluminum body
- Impugnatura rivestita per una presa salda, completa di paramano
Covered handle for a firm grip complete with handguard
- Per rivetti da 2,4 a 4,8 mm (4,8 solo in alluminio)
For rivets from 2.4 to 4.8 mm (4.8 only in aluminum)
- Con molla di ritorno
With return spring
- Completa di 4 testine
With 4 heads



Codice	Ø mm				mm	gr		Barcode	
165602					255	570	1	8033183558343	
		Alluminio / Alluminium	Acciaio / Steel	Rame / Copper					Inox
	2,4	•		•					
	3-3,2	•	•	•					•
	4	•	•	•					•
4,8	•								



165603 RIVETTATRICE MANUALE SUPER MANUAL RIVETER SUPER

- Corpo in alluminio
Aluminum body
- Impugnatura rivestita per una presa salda
Coated handle for a firm grip
- Per rivetti da 2,4 a 4,8 mm
For rivets from 2.4 to 4.8 mm (4.8 only in aluminum)
- Completa di 4 testine
With 4 heads



Codice	Ø mm				mm	gr		Barcode
165603					240	800	1	8033183557230
		Alluminio / Alluminium	Acciaio / Steel	Rame / Copper	Inox			
	2,4	•		•				
	3 -3,2	•	•	•	•			
	4	•	•	•	•			
4,8	•	•	•	•				

165604 RIVETTATRICE DI POTENZA POWER RIVETER

- Corpo in alluminio
Aluminum body
- Impugnatura rivestita per una presa salda
Coated handle for a firm grip
- Per rivetti a stappo da 3 a 6,4 mm
For open rivets from 3 to 6.4 mm
- Completa di 5 testine
With 5 heads



Codice	Ø mm				mm	gr		Barcode
165604					530	1800	1	8033183557247
		Alluminio / Alluminium	Acciaio / Steel	Rame / Copper	Inox			
	3 -3,2	•	•	•	•			
	4	•	•	•	•			
	4,8	•	•	•	•			
	6	•	•	•	•			
6,4	•	•	•	•				

165605 RIVETTATRICE MANUALE A LEVE CORTE SHORT LEVER MANUAL RIVETING MACHINE

- Corpo in alluminio
Aluminum body
- Impugnatura rivestita per una presa salda
Coated handle for a firm grip
- Per rivetti a stappo da 3 a 6,4 mm
For open rivets from 3 to 6.4 mm
- Completa di 5 testine
With 5 heads



Codice	Ø mm			mm	gr		Barcode
165605				385	1350	1	8033183590350
		Alluminio / Alluminium	Acciaio / Steel	Inox			
	3 -3,2	•	•	•			
	4	•	•	•			
	4,8	•	•	•			
	6	•					
6,4	•						

185040 PINZE PERFORTRICI PER LAMIERA
PERFORATING PLIERS FOR METAL SHEET



- Corpo in pressofusione con finitura verniciata
Die-cast body with painted finish

Codice	Ø mm	gr		Barcode
185040	4	330	2	8033183568793
185050	5	333	2	8033183568465
185060	6	333	2	8033183556165
185080	8	342	2	8033183556172



165501 PINZA FUSTELLATRICE PER OCCHIELLI
EYELET DIE CUTTER

- Corpo in lamiera
Sheet metal body
- Impugnatura plastificata
Plasticized handle
- Testa rotante a 6 fori tondi intercambiabili
Rotating head with 6 interchangeable round holes
- Gancio di arresto
Stop hook

Codice	mm	gr		Barcode
165501	240	250	5	8033116535694



165501P PINZA FUSTELLATRICE PER OCCHIELLI PROFESSIONALE
PROFESSIONAL EYELET DIE CUTTER

- Corpo in acciaio
Steel body
- Testa rotante a 6 fori tondi intercambiabili
Rotating head with 6 interchangeable round holes
- Gancio di arresto
Stop hook
- Modello pesante
Heavy model

Codice	mm		Barcode
165501P	240	5	8033183562678



TAGLIO EFFICIENTE PER UN USO PROLUNGATO

03

EFFICIENT CUT FOR PROLONGED USE



LINEA PRO
PRO LINE

- 77** Tenaglie prolungate
Prolonged tongs
- 78** Tenaglie standard
Standard tongs

Tenaglie

Nippers

1 Durezza taglienti 61 HRC
Stripping function



2 Manici prolungati
Extended handles



222643 TENAGLIE PROLUNGATE PER CEMENTISTI E MURATORI EXTENDED TONGS FOR CEMENTISTS AND MASONRY

- ♦ In acciaio al carbonio C45
C45 carbon steel
- ♦ Taglienti ulteriormente temperati con durezza di 61 HRC
Cutting edges further tempered; hardness 61 HRC
- ♦ Manici più lunghi permettono una buona leva per tagli senza sforzo
Longer handles allow good leverage for effortless cuts



Codice	∅ mm	∅ mm	C mm	gr	📦	Barcode
222643	2,5	1,6	190	190	12	8033183842152
222644	3,2	1,8	220	330	12	8033183842169
222645	3,5	2,0	250	430	12	8033183842176
222646	3,5	2,2	280	530	12	8033183842183
222647			300	650	12	8033183842190

222643P TENAGLIE PROLUNGATE PER CEMENTISTI E MURATORI EXTENDED TONGS FOR CEMENTISTS AND MASONRY

- ♦ In acciaio al carbonio C45
C45 carbon steel
- ♦ Taglienti ulteriormente temperati con durezza di 61 HRC
Cutting edges further tempered; hardness 61 HRC
- ♦ Manici più lunghi rivestiti in materiale plastico antiscivolo
Longer handles covered in non-slip plastic material



Codice	∅ mm	∅ mm	C mm	gr	📦	Barcode
222643P	2,5	1,6	175	195	12	8033183844569
222644P	3,2	1,8	220	345	12	8033183844576
222645P	3,5	2,0	250	445	12	8033183844583
222646P	3,5	2,2	280	550	12	8033183844590
222647P			300	680	12	8033183844606



222648 TENAGLIE STANDARD PER CEMENTISTI E MURATORI STANDARD TONGS FOR CEMENTISTS AND MASONRY

- Corpo in acciaio legato
Alloy steel body
- Esecuzione verniciata nera
Black painted execution
- Taglienti ulteriormente temperati con durezza di 61 HRC
Cutting edges further tempered; hardness 61 HRC

Codice	Pezzi / Pieces		mm	gr		Barcode
222648			190	350	12	8033183568892
222649			220	380	12	8033183562319
222650			250	420	12	8033183555588
224210	12	Espositore / Exhibitor 12 x 222650			1	8033183561107
224211	12	Espositore / Exhibitor 12 x 222649			1	8033183568977
224213	12	Espositore / Exhibitor 4 x 222648 - 49 - 50			1	8033183567031



222648P TENAGLIE STANDARD PER CEMENTISTI E MURATORI STANDARD TONGS FOR CEMENTISTS AND MASONRY WITH PLASTICATED HANDLES

- Corpo in acciaio legato
Alloy steel body
- Taglienti ulteriormente temperati con durezza di 61 HRC
Cutting edges further tempered; hardness 61 HRC
- Manici rivestiti in materiale plastico antiscivolo
Non-slip plastic handle

Codice	Pezzi / Pieces		mm	gr		Barcode
222648P			190	350	12	8033183568908
222649P			220	380	12	8033183568915
222650P			250	420	12	8033183568922
224210P	12	Espositore / Exhibitor 12 x 222650P			1	8033183568960
224211P	12	Espositore / Exhibitor 12 x 222649P			1	8033183568984
224212P	12	Espositore / Exhibitor 4 x 222648P - 49P - 50P			1	8033183568991



222602 TENAGLIE PER CEMENTISTI E MURATORI VERNICIATE PAINTED TONGS FOR CEMENTISTS AND MASONRY

- Corpo in acciaio legato
Alloy steel body
- Esecuzione verniciata rossa
Red painted execution
- Taglienti ulteriormente temperati con durezza di 61 HRC
Cutting edges further tempered; hardness 61 HRC

Codice	Pezzi / Pieces		mm	gr		Barcode
222602			220	380	12	8033116532174
222603			250	420	12	8033116532167
224203	25	Espositore / Exhibitor 15 x 222602; 10 x 222603			1	8033116536424



STRUMENTI PER CONNESSIONI PERFETTE

TOOLS FOR PERFECT CONNECTIONS



LINEA PRO
PRO LINE



ISOLATO PER TENSIONE 1000V
INSULATED FOR 1000V VOLTAGE



CONFORME AGLI STANDARD EUROPEI
COMPLIES WITH EUROPEAN STANDARDS



CONFORME ALLE NORME DVE
COMPLIES WITH DVE STANDARDS

80 Pinze per fili e cavi
Pliers for wires and cables

84 Pinze per crimpare
Crimping pliers

87 Pinze per capicorda
Crimping pliers

209101 PINZE SPELAFILI AUTOMATICHE

AUTOMATIC STRIPPING PLIER

- ♦ Lame in acciaio ad alta resistenza
High strength steel blades
- ♦ Modello frontale autoregolabile, con dispositivo di taglio integrato
Self-adjusting front model, with integrated cutting device
- ♦ Ghiera di regolazione della pressione delle lame
Blade pressure adjustment ring
- ♦ Molla di ritorno
Return spring
- ♦ Con funzione tagliacavi
With cable cutter function

Codice	Capacità / Capacity Ø mm	mm	gr		Barcode
209101	0,2 - 6	170	140	1	8033116530255



208701 PINZE SPELAFILI AUTOMATICHE

AUTOMATIC STRIPPING PLIERS

- ♦ Corpo in acciaio con finitura verniciata
Steel body with painted finish
- ♦ Lunghie impugnature antiscivolo in plastica
Long non-slip plastic handles
- ♦ Molla di ritorno
Return spring
- ♦ Con funzione tagliacavi
With cable cutter function

Codice	Capacità / Capacity Ø mm	mm	gr		Barcode
208701	0,5 - 2	170	370	3	8033116539333
208702	1,3 - 2	170	370	3	8033116539340



209001 PINZE SPELAFILI AUTOMATICHE

AUTOMATIC STRIPPING PLIER

- ♦ Corpo in acciaio con finitura verniciata
Steel body with painted finish
- ♦ Manici rivestiti in gomma antiscivolo
Non-slip rubber handles
- ♦ Con funzione tagliacavi
With cable cutter function

Codice	Capacità / Capacity Ø mm	mm	gr		Barcode
209001	0,13 - 6	205	245	1	8033116532310



208601 PINZE SPELAFILI A MOLLA SPRING STRIPPERS

- ◆ Pinze in acciaio per molle
Spring steel pliers
- ◆ Impugnatura in resina sintetica
Synthetic resin grip

Codice	Capacità / Capacity Ø mm	mm	gr		Barcode
208601	0,5	125	30	6	8033116539258
208602	0,6	125	30	6	8033116539265
208603	0,8	125	30	6	8033116539272
208604	1	125	30	6	8033116539289



Codice			Barcode
208601A	Lama ricambio / Spare blade	10	8033116539296
208602A	Lama ricambio / Spare blade	10	8033116539302
208603A	Lama ricambio / Spare blade	10	8033116539319
208604A	Lama ricambio / Spare blade	10	8033116539326

209201 PINZE SGUAINACAVI PER CAVI COASSIALI CABLE STRIPPING PLIERS FOR COAXIAL CABLES

- ◆ Corpo in materiale plastico
Plastic body
- ◆ Per cavi coassiali RG56, RG62, RG6
For RG56, RG62, RG6 coaxial cables

Codice		mm	gr		Barcode
209201	2 lame / With 2 blades	105	42	2	8033116539371
209202	3 lame / With 3 blades	107	52	2	8033116539388



233401 SGUAINACAVI CABLE DRAWER

- ◆ Lama orientabile mediante pulsante a molla
Adjustable blade by means of a spring button
- ◆ Corpo in resina sintetica antiurto
Shockproof synthetic resin body
- ◆ Profondità di taglio regolabile a vite
Adjustable cutting depth by screw
- ◆ Per cavi a sezione tonda in PVC
For PVC round section cables

Codice	Capacità / Capacity Ø mm	mm		Barcode
233401	4,5 - 25	135	2	8033116539944
233401A	Lama ricambio / Spare blade		2	8033183556486

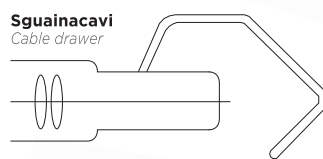

233101 SGUAINACAVI CABLE DRAWER

- ◆ Lama interna regolabile in acciaio
Adjustable internal steel blade
- ◆ Dotato all'interno di lama di ricambio
Equipped with a spare blade

Codice	Capacità / Capacity Ø mm	mm	gr		Barcode
233101	4 - 16	140	70	6	8033116539883
233102	8 - 28	140	70	6	8033116539890
233103	28 - 35	150	73	6	8033116539906
233104	35 - 50	150	73	6	8033116539913

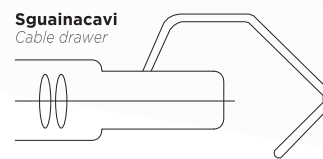

233201 SGUAINACAVI CABLE DRAWER

- Lama interna regolabile in acciaio
Adjustable internal steel blade
- Impugnatura in ABS
ABS handle
- Dotato all'interno di lama di ricambio
Equipped with a spare blade
- Coltello esterno ad un taglio con gancio
External single cut knife with hook

Codice	Capacità / Capacity Ø mm	mm	gr		Barcode
233201	8 - 28	177	80	6	8033116539920

233301 SGUAINACAVI CABLE DRAWER

- Lama interna regolabile in acciaio
Adjustable internal steel blade
- Impugnatura in ABS
ABS handle
- Dotato all'interno di lama di ricambio
Equipped with a spare blade
- Coltello esterno ad un taglio
External single cut knife

Codice	Capacità / Capacity Ø mm	mm	gr		Barcode
233301	8 - 28	190	80	6	8033116539937

023501 COLTELLO SGUAINACAVI CABLE KNIFE

- Lama curva in acciaio INOX
Curved stainless steel blade
- Finitura satinata
Satin finish
- Manico in nylon con paramano
Nylon handle with hand guard
- Adatto a togliere la guaina dei cavi elettrici
Suitable for removing the sheath of electric cables

Codice	Lama mm	mm		Barcode
023501	30	130	6	8033183553010

033501 COLTELLO PER ELETTRICISTI 1000 VOLT KNIFE FOR ELECTRICIANS 1000 VOLT

- Lama fissa in acciaio INOX
Fixed stainless steel blade
- Certificato per l'uso su componenti di tensione fino a 1000 V
Certified for use on voltage components up to 1000 V
- Impugnatura ergonomica in plastica isolata con paramano
Ergonomic insulated plastic handle with handguard
- Con tappo coprilama
With blade cover cap

Codice	Lama mm	mm		Barcode
033501	50	180	6	8033116536905



Coltello esterno
External knife

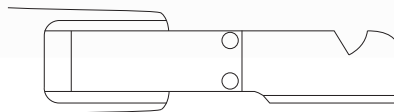

Coltello esterno
External knife

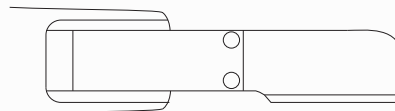

230901 TAGLIACAVI PROFESSIONALE PROFESSIONAL CABLE CUTTERS

- ♦ Corpo in acciaio speciale con esecuzione cromata
Body in special steel with chromed finish
- ♦ Impugnatura con rivestimento in PVC
PVC coating handle
- ♦ Grande capacità di taglio con molla di richiamo
Great cutting capacity with return spring



Codice	Capacità / Capacity Ø mm	mm	gr		Barcode
230901	10	170	235	3	8033116539746
230902	16	230	440	3	8033116539753

231101 TAGLIACAVI CABLE CUTTERS

- ♦ Corpo in acciaio speciale
Special steel body
- ♦ Testa brunita
Burnished head
- ♦ Impugnatura isolata bicomponente con maniglie rivestite
Bi-component insulated handle with coated grip
- ♦ Impugnatura più lunga per ridurre la fatica
Longer handle to reduce fatigue
- ♦ Azionamento meccanico a due mani
Two-hand mechanical operation



Codice	Capacità / Capacity Ø mm	mm	gr		Barcode
231101	12	600	250	1	8033116539784
231102	24	900	490	1	8033116539791

Codice		Barcode
231101L	Lama ricambio / spare blade	1 8033116539807
231102L	Lama ricambio / spare blade	1 8033116539814

231301 TAGLIACAVI A CREMAGLIERA RACK CABLE CUTTERS

- ♦ Corpo in acciaio al cromo vanadio
Chrome vanadium steel body
- ♦ Testa brunita
Burnished head
- ♦ Taglio temprato con affilatura di precisione
Hardened cut with precision sharpening
- ♦ Principio del cricchetto per tagliare i cavi con minimo sforzo
Ratchet principle for cutting cables with minimum effort
- ♦ Impugnatura in lamiera plastificata con paramano
Plastic coated sheet handle with hand guard



Codice	Capacità / Capacity Ø mm	mm	gr		Barcode
231301	32	250	590	1	8033116531290
231302	52	280	810	1	8033116532198

6000153 TAGLIACAVI TESTA BRUNITA CABLE CUTTERS

- ♦ Testa brunita e impugnatura plastificata
Burnished head and plasticized handle



Codice	Capacità / Capacity Ø mm	mm	gr		Barcode
6000153	50	170	210	5	8033183570963

Pinze per crimpare

Crimping pliers

209452 CRIMPATRICE CRIMPING MACHINE

- In acciaio a basso tenore di carbonio con finitura nera
Low carbon steel with black finish
- Impugnatura in TPR + PP bicolore ergonomica
Ergonomic bi-color TPR + PP handle
- Crimpa e taglia il filo esteso in un solo passaggio
Crimp and cut the extended wire in one step
- Per connettori RJ45 modulari non schermati e schermati
For unshielded and shielded modular RJ45 connectors

Codice	mm	gr		Barcode
209452	190	315	1	8033183845603



209453 CRIMPATRICE COMPATTA TIPO "WESTERN" "WESTERN" COMPACT CRIMPING MACHINE

- In acciaio a basso tenore di carbonio con finitura nera
Low carbon steel with black finish
- Impugnatura in TPR + PP bicolore ergonomica
Ergonomic bi-color TPR + PP handle
- Crimpatura parallela
Parallel crimp
- Per connettori RJ45 modulari non schermati
For unshielded modular RJ45 connectors
- Funzione di taglio per cavi circolari CAT6 - CAT5e
Cutting function for CAT6 - CAT5e circular cables

Codice	mm	gr		Barcode
209453	RJ45 (8 posiz. 8 cont.)	160	215	1 8033183845610



209749 CRIMPATRICE TIPO "WESTERN" "WESTERN" CRIMPING MACHINE

- Testa brunita
Burnished head
- Crimpaggio parallelo di precisione
Precision parallel crimping
- Tagliacavi e gli spelacavi integrati per cavi piatti non schermati
Integrated cable cutters and strippers for unshielded flat cables
- Per connettori a 6 e 8 poli tipo RJ11/12 e RJ45
For 6 and 8-pole connectors type RJ 11/12 and RJ45
- Funzione supplementare di spelatura per cavi a sezione tonda
Additional stripping function for round section cables

Codice	mm	gr		Barcode
209749	RJ11 (6 posiz. 4 cont.) RJ12(6 posiz. 6 cont.) RJ45 (8 posiz. 8 cont.)	185	300	1 8033183556813



209751 CRIMPATRICE TIPO "WESTERN" "WESTERN" CRIMPING MACHINE



- Testa brunita
Burnished head
- Manici rivestiti in materiale bicomponente
Bi-component material handles
- Tagliacavi e gli spelacavi integrati per cavi piatti non schermati
Integrated cable cutters and strippers for unshielded flat cables
- Per connettori PLUG 4, 6 e 8 poli RJ10 - RJ11 e RJ45
For PLUG connectors 4, 6 and 8 poles RJ10 - RJ11 and RJ45
- Compreso di cacciavite per sbloccare il cricchetto in caso di necessità
Including screwdriver to release the ratchet in case of need



Codice		mm	gr		Barcode
209751	RJ10 (4 posiz. 4/2 cont.) RJ11 (6 posiz. 4 cont.) RJ45 (8 posiz. 8 cont.)	203	550	1	8033183560773

209435 CRIMPATRICE PER CONNETTORI SOLAR CRIMPING MACHINE SOLAR CONNECTORS

- Testa brunita
Burnished head
- Manici rivestiti in plastica e gomma antiscivolo
Plastic and non-slip rubber handles
- Per la crimpatura e la spelatura di connettori per pannelli solari
For crimping and stripping connectors for solar panels
- Lo stampo di aggraffatura di bloccaggio accurato e completo assicura un'elevata qualità di crimpatura
The accurate and complete locking crimping mold ensures high crimping quality
- Alta trasmissione della forza per facilitarne l'uso
High force transmission to facilitate use



PROCEDURA DI CRIMPAGGIO E INSTALLAZIONE DEI CONNETTORI SOLARI CRIMPING PROCEDURE INSTALLING SOLAR CONNECTORS

- 1 - Inserire il cavo spellato all'interno del contatto da crimpare e premere con decisione.
Insert the stripped cable inside the contact to be crimped e press firmly.
- 2 - Inserire il cavo completo di contatto all'interno del connettore e spingere in modo energico.
Insert the complete contact cable inside the connector e push vigorously
- 3 - Avvitare la ghiera pressacavo manualmente.
Screw the cable gland nut manually



Codice	Capacità / Capacity Ø mm ²	mm		Barcode
209435	1,5 - 2,5 / 4 - 6 / 3	245	1	8033183556981
209435M	Matrice ricambio / Spare matrix		1	8033183558954

- 1** In lamiera per terminali con ganasce in acciaio bonificato con esecuzione brunita.
Sheet metal for terminals with tempered steel jaws with burnished execution.
- 2** Impugnatura in resina sintetica.
Synthetic resin handle.
- 3** Design ergonomico che la rende più facile da impugnare con comoda maniglia per un facile lavoro.
Ergonomic design that makes it easier to hold with comfortable handle for easy work.
- 4** Adattamento automatico alle dimensioni dei terminali a bussola.
Automatic adaptation to the size of the sleeve terminals
- 5** Struttura a cricchetto regolabile.
Adjustable ratchet structure.

209721N CRIMPATRICE PER TERMINALI A BUSSOLA
TERMINAL CRIMPING MACHINE

- **AWG 28 - 10**
28 - 10 AWG
- Pressatura a sezione esagonale **capacità da 0,08 fino a 6 mm²**
Hex free pressing capacity from 0.08 up to 6 mm²
- Pressatura a sezione esagonale per zone di difficile accesso
Pressing with hexagonal section for areas that are difficult to access

Codice	mm	gr		Barcode
209721N	180	380	1	8033183556998



209722 CRIMPATRICE PER TERMINALI A BUSSOLA
TERMINAL CRIMPING MACHINE

- **AWG 28 - 7**
28 - 7 AWG
- Pressatura a sezione quadra **capacità da 0,08 fino a 10 mm²**
Square section pressing capacity from 0.08 to 10 mm²
- Pressatura a sezione quadra per superfici ottimali
Square section pressing for optimal surfaces

Codice	mm	gr		Barcode
209722	180	380	1	8033183561374



209723 CRIMPATRICE PER TERMINALI A BUSSOLA
CRIMPING TOOL FOR SOCKET TERMINALS

- Inserimento frontale dei terminali a bussola nell'utensile
Square section pressing for optimal surfaces

Codice		mm	gr		Barcode	
209723	AWG 28 - 7	0,08 - 10 mm ²	180	380	1	8033183564443
209724	AWG 28 - 5	0,08 - 16 mm ²	180	380	1	8033183557001



Pinze per capicorda

Crimping pliers

- 1 **Corpo in lamiera con ganasce in acciaio microfuso ed esecuzione brunita.**
Sheet metal body with steel jaws.
- 2 **Design ergonomic dell'impugnatura rivestita in materiale antiscivolo.**
Ergonomic handle design covered in non-slip material.
- 3 **Forza di crimpatura regolabile grazie alla ruota dentata.**
Crimping force adjustable thanks to the toothed wheel.

209301 CRIMPATRICE A CRICCHETTO PER CAPICORDA TERMINALS RATCHET CRIMP

- Applicazione: **capicorda isolati**
Application: insulated terminals
- Pressatura con **capacità da 0,5 a 6 mm²**
Pressing capacity from 0.5 to 6 mm²

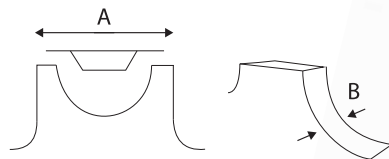

Codice		mm	gr		Barcode
209301	AWG 20 - 10	250	550	1	8033116532143
	A mm ²	●	●	●	
	B mm	11	14		

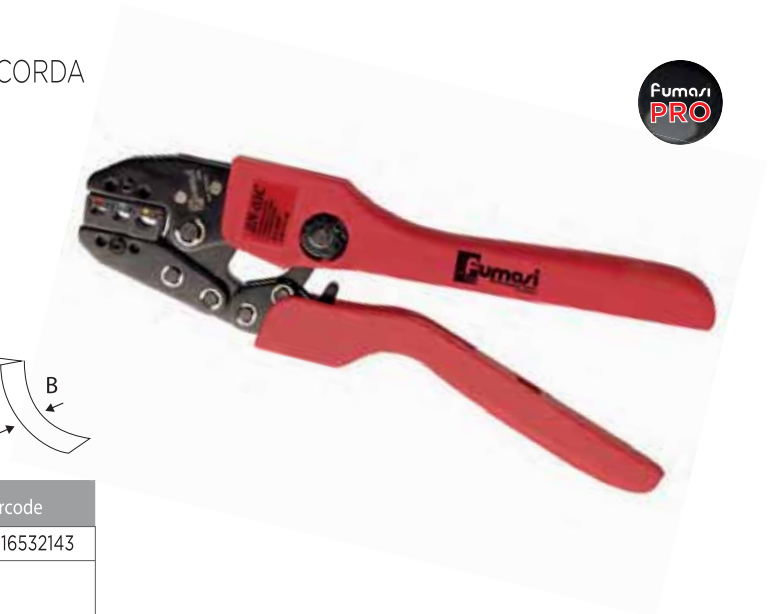

209401 CRIMPATRICE A CRICCHETTO PER CAPICORDA TERMINALS RATCHET CRIMP

- Applicazione: **capicorda non isolati**
Application: non-insulated terminals
- Pressatura con **capacità da 1 a 16 mm²**
Pressing capacity from 1 to 16 mm²

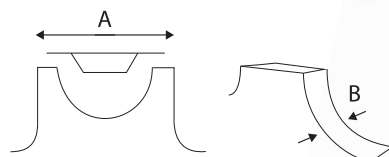

Codice		mm	gr		Barcode
209401	AWG 16 - 8	250	550	1	8033116532150
	A mm ²	1	2	4	6 - 10
	B mm	3	3,5	4	
209402	AWG 14 - 16	250	550	1	8033116539395
	A mm ²	1,5 - 2,5	4 - 6	10	16
	B mm	4			





209449 SET CRIMPATRICE + MATRICI CRIMP + DIES SET

- Pratica e versatile: diversi stampi per soddisfare le diverse applicazioni
Practical and versatile: different molds to suit different applications
- 5 matrici intercambiabili
5 interchangeable matrices

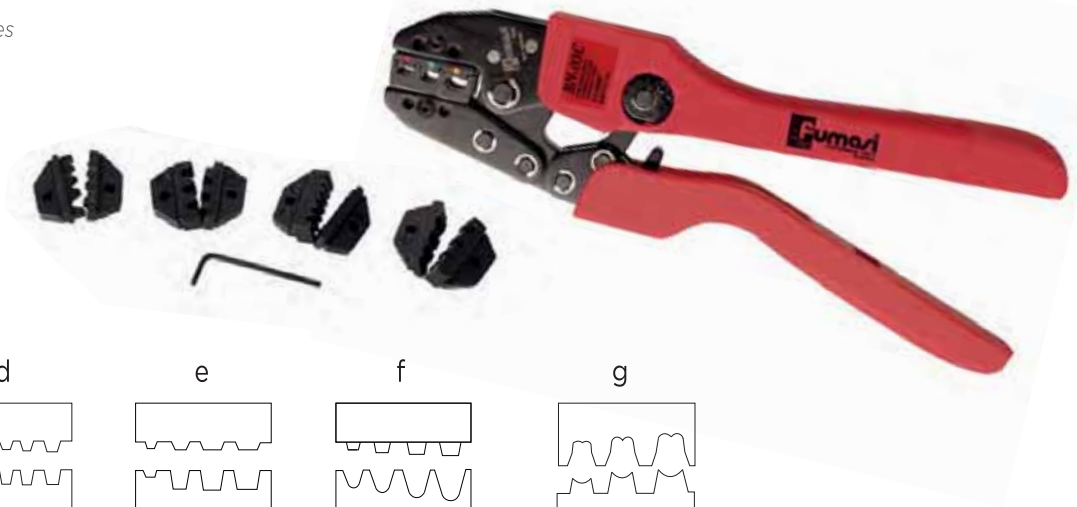

c	d	e	f	g
Capicorda preisolati <i>Pre-insulated terminals</i> AWG 22 - 10	Terminali a bussola <i>Socket terminals</i> AWG 22 - 12	Terminali a bussola <i>Socket terminals</i> AWG 10 - 6	Capicorda non isolati <i>Non-insulated terminals</i> AWG 20 - 7	Capicorda aperti in ottone <i>Open brass terminals</i> AWG 20 - 10

Codice												Barcode	
209449	Pinza 209301 + 4 matrici / 209301 Plier + 4 matrices										1	8033183556974	
	A mm ²	0,25	0,5	0,75	1	1,5	2	2,5	4	5	6	10	16
	c	•	•	•	•	•	•	•	•	•	•		
	d		•	•	•	•	•	•					
	e										•	•	•
	f		•	•	•	•	•	•	•	•	•	•	
g		•	•	•	•	•	•	•	•	•			

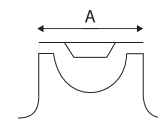

209403 PINZE INDUSTRIALI PER CAPICORDA INDUSTRIAL TERMINALS PLIERS

- Corpo in lamiera e ganasce in acciaio
Practical and versatile: different molds to suit different applications
- Pressatura con capacità da 16 a 50 mm²
Pressing capacity from 16 to 50 mm²

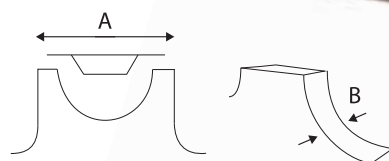

Codice					mm	gr	Barcode
209403					365	550	1
	A mm ²	16	25	50	35		
	B mm	4					



209434 PINZE PER CRIMPARE CRIMP SET FOR TERMINALS

- Corpo in acciaio temperato
Body in tempered steel
- Manico in plastica blu
Blue plastic handle
- Doppia crimpatura del conduttore e dell'isolamento
Double crimping of conductor and insulation

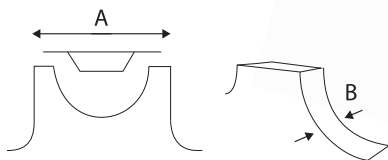

Codice		mm	gr		Barcode		
209434B	Cap. preisolati / Pre-insulated ter.	250	550	1	8033183568847		
	A mm ²	●	●	●			
	B mm						
209434C	Cap. non isolati / Not insulated ter.	250	550	1	8033183568854		
	A mm ²	0,14	1	2,5	4	6	10
	B mm						
209434D	Cap. in ottone / Brass terminals	250	550	1	8033183568861		
	A mm ²	0,5-1	1,5-2,5	4-6			
	B mm						

209433 SET CRIMPATRICE + MATRICI CRIMP + DIES SET

- Pratica e versatile: diversi stampi per soddisfare le diverse applicazioni
Practical and versatile: different molds to suit different applications
- 3 matrici intercambiabili
3 interchangeable matrices

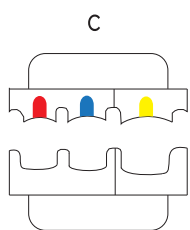

Capicorda preisolati
Pre-insulated terminals

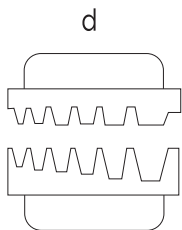

Capicorda non isolati
Non-insulated terminals

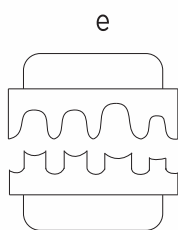

Capicorda in ottone
Brass terminals

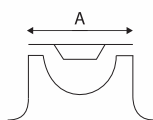

Codice			Barcode										
209433	Pinza + 3 matrici / Plier + 3 matrices	1	8033183568823										
	A mm ²	0,14	0,25	0,5	0,75	1	1,5	2	2,5	4	5	6	10
	c			●	●	●	●	●	●	●	●	●	
	d	●	●	●	●	●	●	●	●	●	●	●	●
	e			●	●	●	●	●	●	●	●	●	

209501 PINZE PER CAPICORDA FASTON FASTON TERMINALS PLIER

♦ Testa brunita
Burnished head

♦ Diverse funzioni:

Tronchese per bulloni (M2,6 - M5): avvitare il bullone nel foro e stringere l'impugnatura

Spelafili: inserire il filo, stringere e far scorrere la guaina esterna

Crimpaggio di terminali tramite l'unione di un filo e una terminazione per compressione

Several functions:

Bolt cutter (M2.6 - M5): Screw the bolt into the hole and tighten the handle

Wire stripper: insert the wire, tighten and slide the outer sheath

Crimping of terminals by joining a wire and a termination by compression

♦ Applicazione: **capicorda isolati**

Application: insulated cable lugs

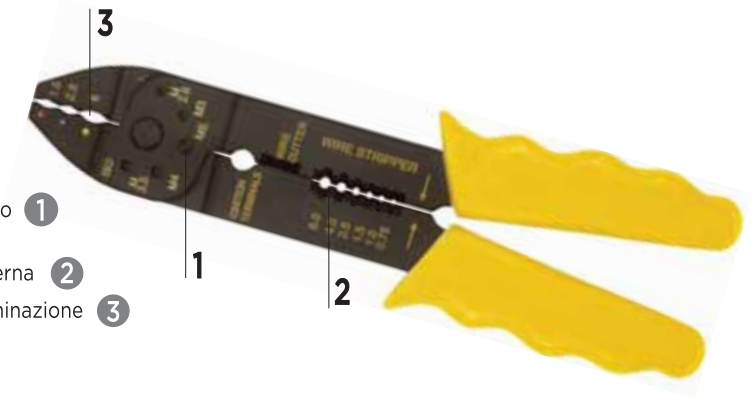
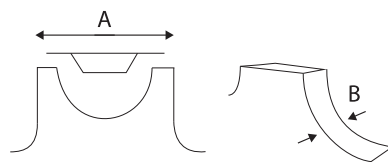

Codice	mm			gr		Barcode
209501		215	200	5		8033116539401
	A mm ²	1,5	2,5	6		
	B mm	3				

209601 PINZE PER CAPICORDA TERMINALS PLIER

♦ Testa brunita
Burnished head

♦ Diverse funzioni:

Tronchese per bulloni (M2,6 - M5): avvitare il bullone nel foro e stringere l'impugnatura

Spelafili: inserire il filo, stringere e far scorrere la guaina esterna

Crimpaggio di terminali tramite l'unione di un filo e una terminazione per compressione

Several functions:

Bolt cutter (M2.6 - M5): Screw the bolt into the hole and tighten the handle

Wire stripper: insert the wire, tighten and slide the outer sheath

Crimping of terminals by joining a wire and a termination by compression

♦ Applicazione: **capicorda non isolati**

Application: non-insulated cable terminals

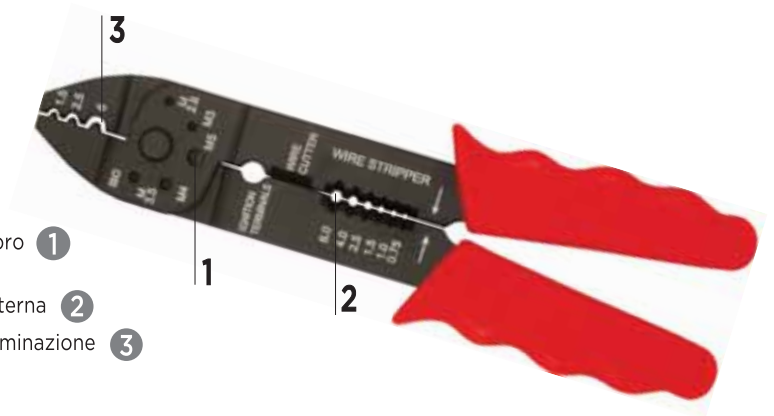
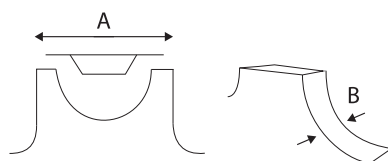

Codice	mm			gr		Barcode
209601		215	200	5		8033116530262
	A mm ²	1,5	2,5	6		
	B mm	3				

209801 SET PINZA PER CAPICORDA FASTON
PLIER SET FOR FASTON TERMINALS

✚ valigetta in plastica trasparente
In transparent plastic case

54 capicorda assortiti + pinza per capicorda
54 assorted terminals + crimping pliers

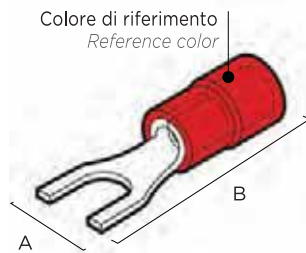

Codice						Barcode
209801						1 8033116539449
		Ø foro mm	A mm	B mm	Qty.	
	●●		6	20	6x	
	●	M5	8	20	6	
	●	M5	9	22	6	
	●●		6	21	6x	
	●●		7	20	6x	
	●	3		25	6	
	●	4		25	6	
Pinza capicorda / Crimping tool				230	1	

209901 SET CAPICORDA FASTON
SET FASTON TERMINALS

✚ valigetta in plastica trasparente
In transparent plastic case

160 capicorda assortiti
160 assorted terminals

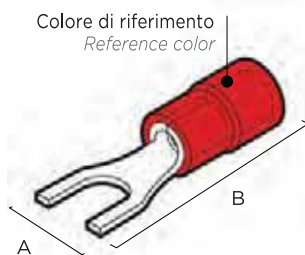

Codice						Barcode
209901						1 8033116530279
		Ø foro mm	A mm	B mm	Qty.	
	●		6	20	10	
	●		7	20	10	
	●		7	20	10	
	●		8	21	7	
	●	M3	5	16	20	
	●	M4	8	20	10	
	●	M3	6	17	10	
	●	M4	8	21	10	
	●	M5	9	22	10	
	●	M5	9	25	5	
	●	M6	12	29	4	
	●		6	21	7x	
	●●		7	20	7x	
	●	3		25	10	
	●	4		25	10	
	●	6		25	5	



UTENSILI MANUALI PER ELETTRICISTI

HAND TOOLS FOR ELECTRICIANS

- 93** Saldatori elettrici
Electric welders
- 95** Articoli per cablaggio
Articles for wiring
- 97** Set di utensili per elettricisti
Electricians tool set

Saldatori e articoli per cablaggio

Welders and items for wiring

615203 SALDATORE ELETTRICO 220V ELECTRIC WELDER 220V

- Corredato di una punta curva ed una diritta
Equipped with a curved and a straight tip
- Manico ergonomico con presa isolata antiscivolo
Ergonomic handle with non-slip insulated grip
- Raggiunge velocemente la sua temperatura d'esercizio
It quickly reaches its operating temperature
- Funziona con corrente di rete 220V
Works with 220V mains current

Codice	mm	mm	mm	Barcode
615203	40W	230	5	8033116538978
615204	60W	240	5	8033183840264

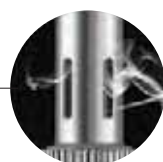

Fori di dissipazione del calore
heat dissipation holes



615206 KIT SALDATORE ELETTRICO PROFESSIONALE 220V PROFESSIONAL ELECTRIC WELDER 220V

- Range di temperatura: da 200° a 450°C con una potenza di 60W
Temperature range: from 200 ° to 450 ° C with a power of 60W
- Supporto a spirale e spugna per la pulizia della punta ①
Spiral holder and sponge for cleaning the tip
- Pompetta dissaldante ②
Desoldering pump
- Rotolo di stagno per saldare Ø 1 mm ③
Roll of tin for soldering Ø 1 mm
- Le 5 punte intercambiabili sono da: 0,2mm, 2mm, 3mm, 4mm e 5mm. ④
The 5 interchangeable tips are: 0.2mm, 2mm, 3mm, 4mm and 5mm.
- Pinzetta antistatica ⑤
Antistatic tweezers



Codice	mm	mm	Barcode
615206	60W - 240mm	1	8033183840202



610001 SALDATORE ELETTRICO A PISTOLA 230V
ELECTRIC GUN WELDER 230V

- ♦ Lampadina integrata che offre una buona guida per la saldatura
Built-in bulb that offers good welding guidance
- ♦ Temperatura di punta di 450 °C
Peak temperature of 450 °C

Codice	gr		Barcode
610001	560	1	8033116539050



611001 POMPETTA PER DISSALDARE MANUALE
PUMP FOR MANUAL DEWELDING

- ♦ Corpo principale in metallo
Main body in metal
- ♦ Impugnatura con superficie in rilievo zigrinata
Handle with knurled relief surface
- ♦ Ugello in gomma silconica, flessibile
Flexible silicone rubber nozzle
- ♦ Fornisce un'efficiente rimozione della saldatura e il relativo smontaggio
Provides efficient weld removal and disassembly

Codice	mm		Barcode
611001	190	1	8033116539067



612002 STAGNO PER SALDARE
TIN FOR WELDING

- ♦ 50% stagno - 50% piombo
50% tin - 50% lead

Codice	Ø mm	gr		Barcode
612002	1,5	100	10	8033116539203
612003	1,5	500	5	8033116539210



612006 STAGNO PER SALDARE SN/99-CU1
TIN FOR WELDING SN / 99-CU1

- ♦ 99% stagno - 0,3% argento - 0,7% rame
99% tin - 0.3% silver - 0.7% copper
- ♦ Senza piombo
Lead-free

Codice	Ø mm	gr		Barcode
612006	1	100	10	8033183556684
612008	1	500	5	8033183556707



614001 PASTA DIOSSIDANTE PER SALDATURE
DIOXIDANT PASTE FOR WELDING

Codice	gr		Barcode
614001	75	10	8033116539227
614002	200	10	8033116539234
614003	400	5	8033116539241



18025F FASCETTE DI CABLAGGIO WIRING CLAMPS

- In nylon di massima qualità
Made of top quality nylon
- Scorrimento veloce della cremagliera nel serraggio grazie al basso coefficiente d'attrito del materiale. Non sganciabili
Fast sliding of the rack when clamping thanks to the bottom coefficient of friction of the material. Not releasable
- Gli spigoli sono arrotondati per non danneggiare i cavi
The edges are rounded to avoid damaging the cables

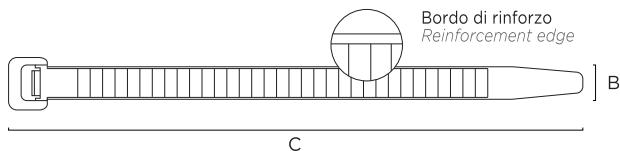

Codice		C x B mm	Set pz./pcs		Barcode
18025FB	Naturale / Natural	80 x 2,5	100	5	8033183575272
18025FN	Nero / Black	80 x 2,5	100	5	8033183575265
10025FB	Naturale / Natural	100 x 2,5	100	5	8033183575296
10025FN	Nero / Black	100 x 2,5	100	5	8033183575289
14025FB	Naturale / Natural	140 x 2,5	100	5	8033183575302
14025FN	Nero / Black	140 x 2,5	100	5	8033183575319
16025FB	Naturale / Natural	160 x 2,5	100	5	8033183575333
16025FN	Nero / Black	160 x 2,5	100	5	8033183575326
20025FB	Naturale / Natural	200 x 2,5	100	5	8033183575357
20025FN	Nero / Black	200 x 2,5	100	5	8033183575340
14036FB	Naturale / Natural	140 x 3,6	100	5	8033183575371
14036FN	Nero / Black	140 x 3,6	100	5	8033183575364
20036FB	Naturale / Natural	200 x 3,6	100	5	8033183575395
20036FN	Nero / Black	200 x 3,6	100	5	8033183575388
37006FB	Naturale / Natural	300 x 3,6	100	5	8033183575401
37006FN	Nero / Black	300 x 3,6	100	5	8033183575418
37036FB	Naturale / Natural	360 x 3,6	100	5	8033183575425
37036FN	Nero / Black	360 x 3,6	100	5	8033183575432
20048FB	Naturale / Natural	200 x 4,8	100	5	8033183575456
20048FN	Nero / Black	200 x 4,8	100	5	8033183575449
30048FB	Naturale / Natural	290 x 4,8	100	5	8033183575463
30048FN	Nero / Black	290 x 4,8	100	5	8033183575470

Codice		C x B mm	Set pz./pcs		Barcode
37048FB	Naturale / Natural	360 x 4,8	100	5	8033183575487
37048FN	Nero / Black	360 x 4,8	100	5	8033183575494
43048FB	Naturale / Natural	430 x 4,8	100	5	8033183575517
43048FN	Nero / Black	430 x 4,8	100	5	8033183575500
53048FB	Naturale / Natural	530 x 4,8	100	5	8033183575524
53048FN	Nero / Black	530 x 4,8	100	5	8033183575531
20076FB	Naturale / Natural	200 x 7,6	100	5	8033183575555
20076FN	Nero / Black	200 x 7,6	100	5	8033183575548
24076FB	Naturale / Natural	240 x 7,6	100	5	8033183575562
24076FN	Nero / Black	240 x 7,6	100	5	8033183575579
30076FB	Naturale / Natural	290 x 7,6	100	5	8033183575593
30076FN	Nero / Black	290 x 7,6	100	5	8033183575586
37076FB	Naturale / Natural	360 x 7,6	100	5	8033183575616
37076FN	Nero / Black	360 x 7,6	100	5	8033183575609
45076FB	Naturale / Natural	450 x 7,6	100	5	8033183575630
45076FN	Nero / Black	450 x 7,6	100	5	8033183575623
57076FB	Naturale / Natural	540 x 7,6	100	5	8033183575647
57076FN	Nero / Black	540 x 7,6	100	5	8033183575654
75076FB	Naturale / Natural	750 x 7,6	100	5	8033183575678
75076FN	Nero / Black	750 x 7,6	100	5	8033183575661

100805 PINZE TIRAFASCETTE PROFESSIONALE PROFESSIONAL CLAMP PULLER

- Corpo in metallo
Metal body
- La leva di taglio consente di tagliare la fascetta in eccesso per un facile utilizzo
The cutting lever allows you to cut off the excess tie for easy use
- Lo sforzo di serraggio viene regolato manualmente
The clamping force is adjusted manually
- Per fascette di larghezza massima di 9,5mm
For cable ties with a maximum width of 9.5mm



Codice		mm	gr		Barcode
100805		194	320	5	8033183552433

100806 PISTOLA TIRAFASCETTE CLAMP PISTOL GUN

- Il design compatto e confortevole garantisce facilità d'uso e sicurezza
The compact and comfortable design ensures ease of use and safety
- Corpo in acciaio legato verniciato e maniglia rivestita in plastica
Painted alloy steel body and plastic-coated handle
- Regolazione semplice della tensione con manopola girevole
Simple tension adjustment with rotary knob
- Taglio automatico della coda della fascetta (da: 2,2 - 4,8 mm x 1,6 mm)
Automatic cable tie tail cut (from: 2.2 - 4.8mm x 1.6mm)

Codice	mm	gr	📦	Barcode
100806	156 x 128	340	5	8033183845627



614008 CONFEZIONE 10 PZ. NASTRO ISOLANTE ADESIVO PACKAGE 10 PCS. ADHESIVE INSULATING TAPE

- Nastri in PVC
PVC tapes
- Evata elasticità e resistenza ad agenti atmosferici, umidità, olio, acidi, alcali e agenti corrosivi
High elasticity and resistance to a weathering, humidity, oil, acids, alkalies, corrosive chemicals



Codice		mm	mt	📦	Barcode
614008	Nero / Black	19	25	10	8033183568496
614009	Blu / Blue	19	25	10	8033183568502
614010	Giallo/verde / yellow/green	19	25	10	8033183568519
614011	Bianco / White	19	25	10	8033183568526
614012	Grigio / Grey	19	25	10	8033183575760

Codice		mm	mt	📦	Barcode
614013	Marrone / Brown	19	25	10	8033183575777
614014	Rosso / Red	19	25	10	8033183575784
614108	Nero / Black	25	25	8	8033183575746
614111	Bianco / White	25	25	8	8033183575753

625001 SONDA TIRAFILO CON TERMINALE THREAD PULL PROBE WITH TERMINAL

Codice		Ø mm	mt	📦	Barcode
625001		4	5	5	8033116531078
625002		4	10	5	8033116531085
625003		4	20	5	8033116531092
625004		4	15	5	8033183561688
625005		4	25	5	8033183571083
625006		4	30	5	8033183571090



605001 LIQUIDO LUBRIFICANTE PER CAVI LUBRICANT FLUID FOR CABLES

- Lubrificante a base d'acqua con un aspetto lattiginoso a Ph7 neutro
Water-based lubricant with a milky appearance at neutral Ph7
- Riduce del 90% l'attrito generato dall'inserimento / rimozione di cavi
Reduces the friction generated by inserting / removing cables by 90%
- Mantiene l'effetto lubrificante anche se usato in presenza di acqua
Maintains the lubricating effect even when used in the presence of water

Codice	Capacità / Capacity L	gr	📦	Barcode
605001	1	1000	10	8033183550606
605002	0,5	500	10	8033183550613



Set di utensili da elettricista

Electrician tools set

► Per specifiche sui portautensili vedi pag. 286 "BORSE E CONTENITORI"
 For specifics on tool holders see p. 286 "BAGS AND CONTAINERS"

100201 ASSORTIMENTO 31 UTENSILI PER ELETTRICISTA ASSORTMENT OF 31 TOOLS FOR ELECTRICIANS

- ♦ **Pinze:** 001102; 003201; 207402; 209101; 209501; 167201
Pliers: 001102; 003201; 207402; 209101; 209501; 167201
- ♦ **Giraviti:** Giraviti a intaglio: cod. 255009; 255201; 255202; ●
 255203; 255601; 255212; 244001; 244201; 045021
 Giraviti a croce PH: cod. 255401; 255405; 255701; 045421 ◀
*Screwdrivers: Slotted screwdrivers: cod. 255009; 255201; 255202;
 255203; 255601; 255212; 244001; 244201; 045021
 PH cross screwdrivers: cod. 255401; 255405; 255701; 045421*
- ♦ **Tronchese diagonale:** cod. 208102
Diagonal nippers: cod. 208102
- ♦ **Sguainacavi:** cod. 209201
Cable strippers: cod. 209201
- ♦ **Forbici per elettricista:** cod. 230836
Electrician's scissors: cod. 230836
- ♦ **Martello per meccanici:** cod. 148002
Mechanics hammer: cod. 148002
- ♦ **Serie di chiavi maschio in anello:** cod. 240801
Set of male ring keys: cod. 240801
- ♦ **Doppio metro:** cod. 600001
Double meter: cod. 600001
- ♦ **Livella hobby:** cod. 603003
Hobby level: cod. 603003
- ♦ **Cazzuola:** cod. 237412
Trowel: cod. 237412
- ♦ **Sonde tirafilo:** cod. 625002
Wire-pulling probes: cod. 625002
- ♦ **Flessometro 5m x 19 mm:** cod. 601007
5m x 19 mm measuring tape: cod. 601007
- ♦ **Scalpelli per muratore:** cod. 236525; 236625
Chisels for mason: cod. 236525; 236625



Borsa in tessuto tecnico: cod. 100425
 Technical fabric bag: cod. 100425

Codice		Barcode
100201	1	8033183551191

100002 ASSORTIMENTO 14 UTENSILI PER ELETTRICISTI ASSORTMENT OF 14 ELECTRICIANS TOOLS

- ♦ **Pinze:** Pinza universale: cod. 201102
Pinza becchi lunghi mezzitondi: cod. 207202
Pinza becchi lunghi mezzi, piegati: cod. 207402
Insulated pliers: 201102 - 207202 - 207402
- ♦ **Tronchese diagonale:** cod. 208102
Diagonal nippers: cod. 208102
- ♦ **Pinza spelafili:** cod. 209101
Stripping pliers: cod. 209101
- ♦ **Giraviti a intaglio isolati:** cod. 053001; 053002; 053003
Insulated slotted screwdrivers: cod. 053001; 053002; 053003
- ♦ **Giraviti a croce PH isolati:** cod. 054001; 054002; 054003
PH insulated cross screwdrivers: cod. 054001; 054002; 054003
- ♦ **Martello per meccanici:** cod. 148102
Mechanics hammer: cod. 148102
- ♦ **Cutter:** cod. 232101
Cutter: cod. 232101
- ♦ **Forbici per elettricista:** cod. 230836
Electrician's scissors: cod. 230836

Borsa in tessuto tecnico: cod. 100424
Technical fabric bag: cod. 100424



Codice		Barcode
100002	1	8033183590367

100722P ASSORTIMENTO 14 UTENSILI PER ELETTRICISTI ASSORTMENT OF 14 TOOLS FOR ELECTRICIANS



- ♦ **Pinze:** Pinza universale: cod. 201102
Pinza becchi lunghi mezzitondi: cod. 207202
Insulated pliers: 201102 - 207202
- ♦ **Tronchese diagonale:** cod. 208102
Diagonal nippers: cod. 208102
- ♦ **Assortimento 6pz. giraviti 1000V:** cod. 045028
Assortment 6pcs. 1000V screwdrivers: cod. 045028
- ♦ **Livella mini:** cod. 603000
Mini spirit level: cod. 603000
- ♦ **Pinza regolabile:** cod. 167201
Adjustable pliers: cod. 167201
- ♦ **Seghetto:** cod. 181501
Saw: cod. 181501
- ♦ **Flessometro 5m x 19 mm:** cod. 601007
5m x 19 mm measuring tape: cod. 601007
- ♦ **Scalpelli per elettricista:** cod. 236002; 236102
Chisels for electrician: cod. 236002; 236102
- ♦ **Martello per meccanici:** cod. 148003
Mechanics hammer: cod. 148003
- ♦ **Cutter:** cod. 232101
Cutter: cod. 232101
- ♦ **Forbici per elettricista:** cod. 230836
Electrician's scissors: cod. 230836
- ♦ **Guanto in fiore in pelle bovina:** cod. 609001
Cowhide grain glove: cod. 609001

Valigia in alluminio: cod. 100722
Aluminum case: cod. 100722



Codice		Barcode
100722P	1	8033183556028

102600 TROUSSE ASSISTENZA 9 UTENSILI PER ELETTRICISTI ASSISTANCE TROUSSE FOR ELECTRICIANS

- Tronchese diagonale: cod. 208102
Diagonal nippers: cod. 208102
- Giraviti a intaglio: cod. 2454N01 
Slotted screwdrivers: cod. 2454N01
- Giraviti a croce PH: cod. 2452N01 
PH cross screwdrivers: cod. 2452N01
- Martello per meccanici: cod. 148001
Mechanics hammer: cod. 148001
- Cutter: cod. 232101
Cutter: cod. 232101
- Flessometro magnetico 3mt x 16mm: cod. 601006
Magnetic tape measure 3m x 16mm: cod. 601006
- Nastro isolante nero: cod. 614008
Black insulating tape: cod. 614008
- Giravite cercafase: cod. 244001
Phase testing screwdriver: cod. 244001
- Forbici per elettricista: cod. 230835
Electrician's scissors: cod. 230835

Trousse in nylon: cod. 102600V
Nylon cosmetic bag: cod. 102600V



Codice		Barcode
102600	1	80331835855752

100457 SET 2 UTENSILI 2 TOOLS SET

- Forbici elettricista: cod. 230835
Electrician's scissors: cod. 230835
- Giravite cercafase : cod. 244001
Phase finder screwdriver: cod. 244001

Trousse in cordura: cod. 100457V
Cordura cosmetic bag: cod. 100457V

Codice	gr		Barcode
100457	94	5	8033183551276



100456 SET 3 UTENSILI 3 TOOLS SET



- Forbici per elettricista: cod. 230835
Electrician's scissors: cod. 230835
- Giraviti a intaglio isolati: cod. 053003 
Insulated slotted screwdrivers: cod. 053003
- Giraviti a croce PH isolati: cod. 054002 
PH insulated cross screwdrivers: cod. 054002

Trousse in cordura: cod. 100456V
Cordura cosmetic bag: cod. 100456V

Codice	gr		Barcode
100456	172	5	8033183551283



100449 SET 4 UTENSILI 4 TOOLS SET

- ♦ Pinza universale: cod. 210901
Universal pliers: cod. 201101
- ♦ Forbici per elettricista: cod. 230835
Electrician's scissors: cod. 230835
- ♦ Giraviti a intaglio isolati: cod. 053003 
Insulated slotted screwdrivers: cod. 053003
- ♦ Giraviti a croce PH isolati: cod. 054002 
PH insulated cross screwdrivers: cod. 054002

Trousse in cordura (nera) : cod. 100450V
Cordura bag: cod. 100450V

Trousse in nylon (rossa) : cod. 100470V
Nylon bag: cod. 100456V



Codice				Barcode
100449	Nera / Black	100450V	5	8033183575722
100471	Rossa / Red	100470V	5	8033183568243

100450 SET 4 UTENSILI 4 TOOLS SET

- ♦ Pinza universale: cod. 210901
Universal pliers: cod. 201101
- ♦ Forbici per elettricista: cod. 230835
Electrician's scissors: cod. 230835
- ♦ Giraviti a intaglio: cod. 2454N01 
Slotted screwdrivers: cod. 2454N01
- ♦ Giraviti a croce PH: cod. 2452N01 
PH cross screwdrivers: cod. 2452N01

Trousse in cordura (nera) : cod. 100450V
Cordura bag: cod. 100450V

Trousse in nylon (rossa) : cod. 100470V
Nylon bag: cod. 100456V



Codice			gr		Barcode
100450	Nera / Black	100450V	500	5	8033116532730
100470	Rossa / Red	100470V	500	5	8033183551269

ALTA RESISTENZA E PRECISIONE OPERATIVA

HIGH RESISTENCE & OPERATIONAL PRECISION



LINEA PRO
PRO LINE



ISOLATO PER TENSIONE 1000V
INSULATED FOR 1000V VOLTAGE



CONFORME AGLI STANDARD EUROPEI
COMPLIES WITH EUROPEAN STANDARDS



CONFORME ALLE NORME DVE
COMPLIES WITH DVE STANDARDS



IMPRONTA TORX CON FORO
TORX IMPRINT WITH HOLE



IMPRONTA TORX
TORX IMPRINT



IMPRONTA POLIGONALE
POLYGONAL IMPRINT



IMPRONTA ESAGONALE
HEXAGONAL IMPRINT



IMPRONTA SFERICA
SPHERICAL IMPRINT



UTILIZZO TRAMITE MARTELLLO
USE BY HAMMER

- 102** Chiavi universali
Universal keys
- 112** Chiavi maschio
Male keys
- 117** Chiavi a "T"
"T" Keys
- 122** Chiavi a tubo
Pipe wrenches
- 126** Chiavi a bussola
Socket wrenches
- 131** Chiavi 1000 VOLT
1000 VOLT Keys

Chiavi a forchetta

Double fork wrenches

- 1** Corpo in acciaio al cromo vanadio di alta qualità.
High quality chrome vanadium steel body.
- 2** Esecuzione a finitura cromata lucida per resistere alla corrosione e agli agenti atmosferici.
Polished chrome finish execution to resist corrosion and atmospheric agents.

310001 CHIAVI A FORCHETTA DOPPIE DOUBLE FORK WRENCHES

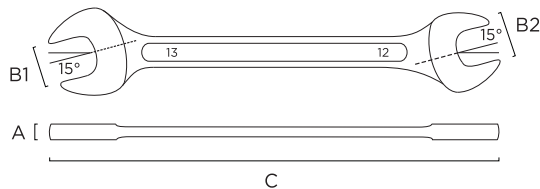

Codice	B2 X B1 mm	A ≈ mm	C mm	gr		Barcode
310001	6 x 7	3,2	120	20	10	8033116530309
310002	8 x 9	4,0	135	30	10	8033116530316
310004	10 x 11	4,3	150	50	10	8033116530323
310006	12 x 13	5,0	165	70	10	8033116530330
310007	14 x 15	5,2	180	95	10	8033116530347
310009	16 x 17	5,3	195	125	10	8033116530354
310011	18 x 19	6,5	210	160	10	8033116530361
310013	20 x 22	7,0	225	195	10	8033116530378
310014	21 x 23	7,6	240	220	5	8033116530385
310015	24 x 26	8,0	260	300	5	8033116530392
310016	24 x 27	8,0	260	300	5	8033116539951
310017	25 x 28	8,6	280	350	5	8033116539968
310018	27 x 29	8,8	280	355	5	8033116539975
310019	30 x 32	9,0	300	450	5	8033116531160
310020	36 x 41	13,0	350	800	5	8033116539982



310801 SERIE CHIAVI A FORCHETTA DOPPIE
SET OF DOUBLE FORK WRENCHES

Scatola / Box

Codice	Pezzi / Pieces		gr		Barcode
310801	8	310001 - 02 - 04 - 06 - 07 - 09 - 11 - 13	900	1	8033116539999
311201	12	310001 - 02 - 04 - 06 - 07 - 09 - 11 - 13 - 14 - 16 - 17 - 19	2300	1	8033116540018
311301	13	310001 - 02 - 04 - 06 - 07 - 09 - 11 - 13 - 14 - 16 - 17 - 18 - 19	2500	1	8033116540025



312001 SERIE CHIAVI A FORCHETTA DOPPIE
SET OF DOUBLE FORK WRENCHES

Tasca similpelle / Leatherette pocket

Codice	Pezzi / Pieces		gr		Barcode
312001	8	310001 - 02 - 04 - 06 - 07 - 09 - 11 - 13	900	1	8033116540032
312002	12	310001 - 02 - 04 - 06 - 07 - 09 - 11 - 13 - 14 - 16 - 17 - 19	2300	1	8033116540049



313001 SERIE CHIAVI A FORCHETTA DOPPIE
SET OF DOUBLE FORK WRENCHES

Supporto in lamiera / Sheet metal support

Codice	Pezzi / Pieces		gr		Barcode
313001	12	310001 - 02 - 04 - 06 - 07 - 09 - 11 - 13 - 14 - 16 - 17 - 19	2640	1	8033116540056



316001P SERIE CHIAVI A FORCHETTA DOPPIE
SET OF DOUBLE FORK WRENCHES

Codice	Pezzi / Pieces	Confezione / Packaging		gr		Barcode
316001P	8		310001 - 02 - 04 06 - 07 - 09 - 11 - 13	1800	1	8033183592460
316001	8		310001 - 02 - 04 06 - 07 - 09 - 11 - 13	780	1	8033116540063



415001 CHIAVI A FORCHETTA DOPPIE MOD. LEGGERO DOUBLE FORK WRENCHES MOD. LIGHT

♦ In acciaio zincato
In galvanized steel

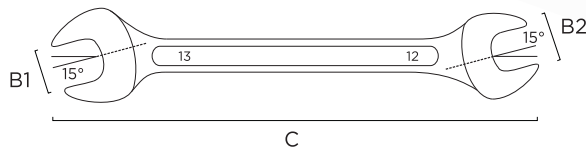

Codice	B2 x B1 mm	C mm	gr		Barcode
415001	6 x 7	90	18	1	8033183565006
415002	8 x 9	105	22	1	8033183565013
415003	8 x 10	110	25	1	8033183572165
415004	10 x 11	120	40	1	8033116542838
415005	10 x 12	125	45	1	8033183560759
415006	10 x 13	130	46	1	8033183560766
415007	11 x 13	135	49	1	8033183565037
415008	12 x 13	137	54	1	8033183572172
415009	12 x 14	140	55	1	8033183565044
415010	13 x 14	146	56	1	8033116542876
415011	13 x 15	153	70	1	8033183565051
415012	13 x 17	158	75	1	8033183564368
415013	14 x 15	158	80	1	8033183565068
415014	14 x 17	160	85	1	8033183565075
415015	16 x 17	174	100	1	8033183565082
415016	17 x 19	192	130	1	8033183565099
415017	18 x 19	192	140	1	8033183565105
415018	19 x 22	200	165	1	8033183564641
415019	19 x 24	224	220	1	8033183565112

Codice	B2 x B1 mm	C mm	gr		Barcode
415020	20 x 22	210	185	1	8033183565129
415021	21 x 23	223	200	1	8033183562500
415022	22 x 24	230	240	1	8033183565136
415023	24 x 26	240	275	1	8033183565143
415024	24 x 27	240	280	1	8033183565150
415025	24 x 30	264	330	1	8033183565167
415026	25 x 28	252	400	1	8033183565174
415027	27 x 30	268	420	1	8033183565181
415028	27 x 32	268	420	1	8033183565198
415029	30 x 32	282	430	1	8033183565204
415030	30 x 36	305	505	1	8033183565211
415031	32 x 36	324	640	1	8033183562494
415032	34 x 38	326	720	1	8033183562739
415033	36 x 41	350	850	1	8033183565228
415034	41 x 46	390	1150	1	8033183564276
415035	46 x 50	420	1340	1	8033183650230
415036	50 x 55	460	2100	1	8033183565235
415037	55 x 60	500	2260	1	8033183564283

414001 CHIAVI A FORCHETTA SEMPLICI MOD. LEGGERO SIMPLE FORK WRENCHES MOD. LIGHT

♦ In acciaio zincato
In galvanized steel

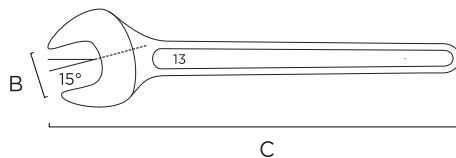

Codice	B mm	C mm	gr		Barcode
414001	6	75	10	1	8033183570246
414002	7	80	10	1	8033183570253
414003	8	90	18	1	8033183570260
414004	9	100	20	1	8033183570277
414005	10	110	23	1	8033183561237
414006	11	120	40	1	8033183570284
414007	12	125	40	1	8033183570291
414008	13	130	45	1	8033183561220
414009	14	140	45	1	8033183570307
414010	15	150	65	1	8033183570314
414011	16	160	70	1	8033183570321
414012	17	160	70	1	8033183558671
414013	18	170	95	1	8033183570338
414014	19	180	100	1	8033183558688
414015	22	200	150	1	8033183559234
414016	24	220	180	1	8033183559241
414017	27	240	235	1	8033183562715
414018	30	260	315	1	8033183559203
414019	32	280	340	1	8033183559210
414020	34	290	340	1	8033183559258
414021	36	320	455	1	8033183558695

Codice	B mm	C mm	gr		Barcode
414022	38	330	540	1	8033183559227
414023	41	350	580	1	8033183557933
414024	42	350	580	1	8033183560247
414025	46	380	750	1	8033183558657
414026	50	420	950	1	8033183559272
414027	55	460	1160	1	8033183558701
414028	60	500	1625	1	8033183561404
414029	65	540	1705	1	8033183561947
414030	70	540	2500	1	8033183570345
414031	75	580	3500	1	8033183560322
414032	80	620	3500	1	8033183570352
414033	85	670	4780	1	8033183560711
414034	90	700	5450	1	8033183570369
414035	95	730	5950	1	8033183570376
414036	100	760	7800	1	8033183570383
414037	105	1000	8000	1	8033183560674
414038	110	1000	8230	1	8033183570390
414039	115	1000	8230	1	8033183570406
414040	120	1000	8240	1	8033183570413
414042	130	1000	8240	1	8033183570437

415301 CHIAVI A FORCHETTA SEMPLICI A PERCUSSIONE SIMPLE FORK WRENCHES WITH IMPACT

- ◆ In acciaio al cromo vanadio
In chrome vanadium steel
- ◆ Finitura nera brunita con trattamento anticorrosione
Black finish with anti-corrosion treatment



Codice	B mm	A ≈ mm	C mm	gr		Barcode
415301	24	16	160	300	1	8033183557032
415302	27	17	180	360	1	8033183557056
415303	30	17	190	550	1	8033183557063
415304	32	17	195	550	1	8033183557070
415305	36	18	210	850	1	8033183557087
415306	41	19	230	1040	1	8033183557094
415307	46	20	250	1390	1	8033183557100

Codice	B mm	A ≈ mm	C mm	gr		Barcode
415308	50	21	275	1640	1	8033183557117
415309	55	24	305	2250	1	8033183557124
415310	60	24	315	2540	1	8033183557131
415311	65	28	345	3640	1	8033183557148
415312	70	30	370	4000	1	8033183557155
415313	75	30	385	5000	1	8033183557162

Chiavi combinate

Combined keys

- 1** Corpo in acciaio al cromo vanadio di alta qualità.
High quality chrome vanadium steel body.
- 2** Esecuzione a finitura cromata lucida per resistere alla corrosione.
Polished chrome finish execution to resist corrosion.

330001 CHIAVI COMBinate STANDARD STANDARD COMBINATION WRENCHES

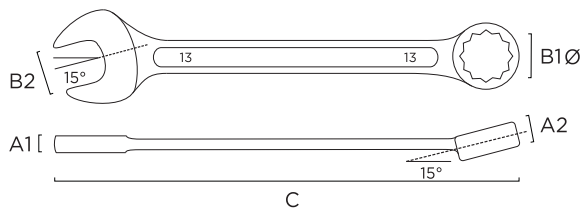

Codice	B2 X B1 mm	A1 ≈ mm	A2 ≈ mm	C mm	gr		Barcode
330001	6 x 6	4,0	5,0	105	15	10	8033116530408
330002	7 x 7	4,0	5,2	110	19	10	8033116530415
330003	8 x 8	4,1	5,7	120	25	10	8033116530422
330004	9 x 9	4,2	6,2	125	30	10	8033116530439
330005	10 x 10	4,3	7,3	135	40	10	8033116530446
330006	11 x 11	5,0	8,2	145	45	10	8033116530460
330007	12 x 12	6,5	8,9	155	58	10	8033116530477
330008	13 x 13	7,0	9,0	165	75	10	8033116530484
330009	14 x 14	7,0	9,2	175	85	10	8033116530491
330010	15 x 15	7,0	9,4	185	100	10	8033116530507
330011	16 x 16	7,1	9,9	185	100	10	8033116530507
330012	17 x 17	7,1	11,0	205	125	10	8033116530514
330013	18 x 18	7,2	11,1	205	125	10	8033116530521
330014	19 x 19	7,2	11,2	230	160	10	8033116530538

Codice	B2 X B1 mm	A1 ≈ mm	A2 ≈ mm	C mm	gr		Barcode
330015	20 x 20	7,3	12,0	230	160	10	8033116530545
330016	21 x 21	7,9	12,2	250	195	10	8033116540148
330017	22 x 22	8,3	12,3	250	195	10	8033116540155
330018	23 x 23	8,3	13,0	270	275	5	8033116540162
330019	24 x 24	8,6	14,0	270	275	5	8033116531610
330020	25 x 25	8,6	14,5	290	275	5	8033116540179
330021	26 x 26	8,6	15,0	290	350	5	8033116540186
330022	27 x 27	9,1	15,0	310	420	5	8033116540193
330023	28 x 28	9,1	15,5	310	420	5	8033116540209
330024	29 x 29	9,1	15,7	330	495	5	8033116540216
330025	30 x 30	10,0	16,0	330	495	5	8033116540223
330026	32 x 32	10,5	16,5	360	575	5	8033116540230
330027	34 x 34	10,5	16,5	380	600	5	8033116540247
330028	36 x 36	10,5	17,0	400	650	5	8033116540254

330801 SERIE CHIAVI COMBinate
COMBINATION WRENCH SERIES

Scatola / Box

Codice	Pezzi / Pieces		gr		Barcode
330801	8	330002 - 03 - 05 - 06 - 08 - 12 - 14 - 17	760	1	8033116540261
331701	17	330001 - 02 - 03 - 04 - 05 - 06 - 07 - 08 - 09 - 10 - 11 - 12 - 13 - 14 - 15 - 16 - 17	1630	1	8033116531337
332601	26	330001 - 02 - 03 - 04 - 05 - 06 - 07 - 08 - 09 - 10 - 11 - 12 - 13 - 14 - 15 - 16 - 17 - 18 - 19 - 20 - 21 - 22 - 23 - 24 - 25 - 26	5010	1	8033116540278



05

333001 SERIE CHIAVI COMBinate
COMBINATION WRENCH SERIES

Tasca in PVC / PVC pocket

Codice	Pezzi / Pieces		gr		Barcode
333001	8	330002 - 03 - 05 - 06 - 08 - 12 - 14 - 17	845	5	8033116531344
333002	12	330001 - 02 - 03 - 04 - 05 - 06 - 07 - 08 - 09 - 12 - 14 - 17	1100	5	8033116540285
333001E	25	da 6 mm a 32 mm	7600	5	8033183553737



334001 SERIE CHIAVI COMBinate
COMBINATION WRENCH SERIES

Supporto in lamiera / Sheet metal support

Codice	Pezzi / Pieces		gr		Barcode
334001	17	330001 - 02 - 03 - 04 - 05 - 06 - 07 - 08 - 09 - 10 - 11 - 12 - 13 - 14 - 15 - 16 - 17	2160	1	8033116540292
334002	26	330001 - 02 - 03 - 04 - 05 - 06 - 07 - 08 - 09 - 10 - 11 - 12 - 13 - 14 - 15 - 16 - 17 - 18 - 19 - 20 - 21 - 22 - 23 - 24 - 25 - 26	5150	1	8033183558909



336001P SERIE CHIAVI COMBinate
COMBINATION WRENCH SERIES

Codice	Pezzi / Pieces	Confezione / Packaging		gr		Barcode
336001P	8		330002 - 04 - 05 - 06 - 08 - 12 - 14 - 17	1780	1	8033183592477
336001	8		330002 - 04 - 05 - 06 - 08 - 12 - 14 - 17	760	1	8033116540308



335008 CHIAVI COMBinate A CRICCHETTO FISSE FIXED RATCHET COMBINATION WRENCHES



- Cricchetto fisso
Fixed ratchet
- Cricchetto reversibile a 72 denti
72 tooth reversible ratchet
- Leva di inversione integrata
Integrated reverse lever

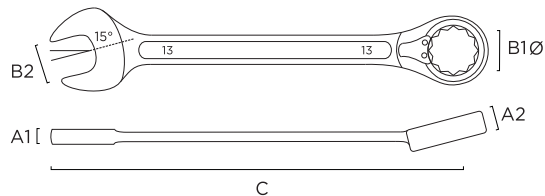

Codice	B2 X B1 mm	A1 ≈ mm	A2 ≈ mm	C mm	gr		Barcode
335008	8 x 8	4,6	7,0	135	112	5	8033116540315
335009	9 x 9	4,8	7,2	145	123	5	8033183551313
335010	10 x 10	5,0	7,6	155	160	5	8033116540322
335011	11 x 11	5,0	8,0	165	179	5	8033116540339
335012	12 x 12	5,4	8,4	170	210	5	8033116540346
335013	13 x 13	6,3	8,9	175	235	5	8033116540353
335014	14 x 14	6,6	9,3	190	290	5	8033116540360

Codice	B2 X B1 mm	A1 ≈ mm	A2 ≈ mm	C mm	gr		Barcode
335015	15 x 15	7,0	10,0	200	335	5	8033116540377
335016	16 x 16	7,5	10,5	210	385	5	8033116540384
335017	17 x 17	7,5	10,7	220	485	5	8033116540391
335018	18 x 18	7,7	11,6	235	535	5	8033116540407
335019	19 x 19	8,3	11,6	245	610	5	8033116540414
335021	21 x 21	10,0	13,4	285	885	5	8033183554710
335022	22 x 22	11,0	13,5	285	905	3	8033183554871

335108 SERIE CHIAVI A CRICCHETTO FISSE FIXED RATCHET WRENCH SET

Valigetta in plastica / *Plastic case*

Codice	Pezzi / Pieces	gr		Barcode	
335108	8	335008 - 10 - 11 - 12 - 13 - 14 - 17 - 19	150	1	8033116540544
335112	12	335008 - 9 - 10 - 11 - 12 - 13 - 14 - 15 - 16 - 17 - 18 - 19	200	1	8033116540551



335508 CHIAVI COMBinate A CRICCHETTO SNODATE COMBINATION WRENCHES WITH ARTICULATED RATCHET

- Cricchetto mobile a 180°
Mobile ratchet at 180°
- Cricchetto reversibile a 72 denti
72 tooth reversible ratchet
- Leva di inversione integrata
Integrated reverse lever

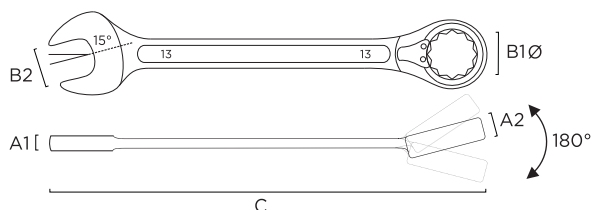

Codice	B2 X B1 mm	A1 ≈ mm	A2 ≈ mm	C mm	gr		Barcode
335508	8 x 8	4,0	7,8	130	140	5	8033116540421
335509	9 x 9	4,6	7,8	135	150	5	8033116540438
335510	10 x 10	4,7	8,5	145	195	5	8033116540445
335511	11 x 11	5,3	8,3	155	225	5	8033116540452
335512	12 x 12	5,8	8,6	165	270	5	8033116540469
335513	13 x 13	5,5	9,0	170	300	5	8033116540476
335514	14 x 14	6,2	9,6	185	360	5	8033116540483

Codice	B2 X B1 mm	A1 ≈ mm	A2 ≈ mm	C mm	gr		Barcode
335515	15 x 15	6,5	10,2	190	460	5	8033116540490
335516	16 x 16	6,5	10,7	205	560	5	8033116540506
335517	17 x 17	6,9	11,0	210	650	5	8033116540513
335518	18 x 18	7,6	11,2	230	765	5	8033116540520
335519	19 x 19	8,4	12,0	250	1090	5	8033116540537
335521	21 x 21	9,0	13,6	285	1115	5	8033183555014
335522	22 x 22	9,2	13,8	285	1235	3	8033183555021

335507 SERIE CHIAVI A CRICCHETTO SNODATE SET OF ARTICULATED RATCHET WRENCHES

Valigetta in plastica / Plastic case

Codice	Pezzi / Pieces		gr		Barcode
335507	7	335508 - 10 - 12 - 13 - 14 - 17 - 19	355	1	8033116540568
335502	12	335508 - 9 - 10 - 11 - 12 - 13 - 14 - 15 - 16 - 17 - 18 - 19	870	1	8033116540575



Chiavi poligonali

Polygonal keys

- 1** Corpo in acciaio al cromo vanadio di alta qualità.
High quality chrome vanadium steel body.
- 2** Esecuzione a finitura cromata lucida per resistere alla corrosione.
Polished chrome finish execution to resist corrosion.

320001 CHIAVI POLIGONALI DOPPIE DOUBLE POLYGONAL KEYS

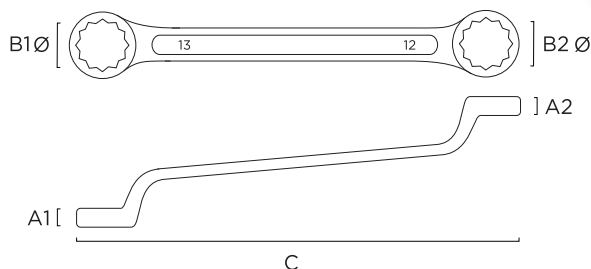

Codice	B2 X B1 mm	A1 ≈ mm	A2 ≈ mm	C mm	gr		Barcode
320001	6 x 7	5,6	5,0	165	45	10	8033116530552
320002	8 x 9	7,9	12,2	180	65	10	8033116530569
320003	10 x 11	8,3	12,3	190	85	10	8033116530576
320004	12 x 13	8,3	13,0	210	110	5	8033116530583
320005	14 x 15	8,6	14,0	225	145	5	8033116530590
320006	16 x 17	8,6	14,5	245	190	5	8033116530606

Codice	B2 X B1 mm	A1 ≈ mm	A2 ≈ mm	C mm	gr		Barcode
320007	18 x 19	8,6	15,0	265	250	5	8033116530613
320008	20 x 22	9,1	15,0	290	340	5	8033116530620
320009	21 x 23	9,1	15,5	305	380	5	8033116540070
320010	24 x 27	9,1	15,7	325	480	5	8033116540087
320011	25 x 28	10,0	16,0	335	550	5	8033116540094
320012	30 x 32	10,5	16,5	360	725	5	8033116540100

320801 SERIE CHIAVI POLIGONALI DOPPIE DOUBLE POLYGONAL KEYS SERIES

Scatola / Box

Codice	Pezzi / Pieces		gr		Barcode
320801	8	320001 - 02 - 03 - 04 - 05 - 06 - 07 - 08	1310	1	8033116540117
321201	12	320001 - 02 - 03 - 04 - 05 - 06 - 07 - 08 - 09 - 10 - 11 - 12	3210	1	8033116540124



323001 SERIE CHIAVI POLIGONALI DOPPIE
DOUBLE POLYGONAL KEYS SERIES

Supporto in lamiera / Sheet metal support

Codice	Pezzi / Pieces		gr		Barcode
323001	12	320001 - 02 - 03 - 04 - 05 - 06 - 07 - 08 - 09 - 10 - 11 - 12	3770	1	8033116540131



320022 CHIAVI POLIGONALI DOPPIE PER PONTEGGI
DOUBLE POLYGONAL KEYS FOR SCAFFOLDING

Codice	B2 X B1 mm	A1 ≈ mm	A2 ≈ mm	C mm	gr		Barcode
320022	21 x 22	13,0	13,0	290	340	10	8033116547031

416001 CHIAVI POLIGONALI SEMPLICI A PERCUSSIONE
SIMPLE POLYGONAL IMPACT WRENCHES

- In acciaio al cromo vanadio
In chrome vanadium steel
- Finitura nera con trattamento anticorrosione
Black finish with anti-corrosion treatment



Codice	B mm	A ≈ mm	C mm	gr		Barcode
416001	24	15	160	290	1	8033183562272
416002	27	16	175	320	1	8033183567536
416003	30	17	193	440	1	8033183560681
416004	32	17	193	470	1	8033183560698
416005	36	18	213	700	1	8033183559289
416006	41	20	213	790	1	8033183557902
416007	46	22	240	975	1	8033183560704

Codice	B mm	A ≈ mm	C mm	gr		Barcode
416008	50	24	245	980	1	8033183561015
416009	55	25	270	1600	1	8033183557919
416010	60	26	273	1750	1	8033183570444
416011	65	30	300	2180	1	8033183562470
416012	70	33	305	2400	1	8033183560742
416013	75	33	330	3000	1	8033183560148

317001 CHIAVI PER RACCORDI TUBI
PIPE FITTINGS WRENCHES

- Bocche aperte
Open mouths

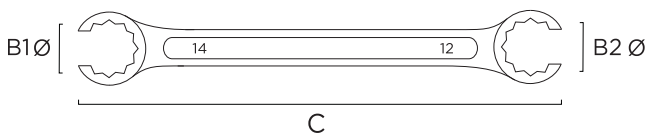

Codice	B2 X B1 mm	C mm	gr		Barcode
317001	8 x 10	130	30	1	8033183557773
317002	9 x 11	150	45	1	8033183567628
317003	10 x 11	150	50	1	8033183557780
317004	11 x 13	170	70	1	8033183557797
317005	12 x 14	170	80	1	8033183557803

Codice	B2 X B1 mm	C mm	gr		Barcode
317006	17 x 19	215	165	1	8033183556745
317007	19 x 22	230	240	1	8033183556622
317008	22 x 24	245	312	1	8033183556615
317009	24 x 27	260	342	1	8033183557698
317010	30 x 32	285	450	1	8033183557704

Chiavi a settore

Sector keys

441203 CHIAVI A SETTORE NASELLO QUADRO

SQUARE NOSE SECTOR KEYS

Disponibile su richiesta fino a 280 x 300mm
Available on request up to 280 x 300mm

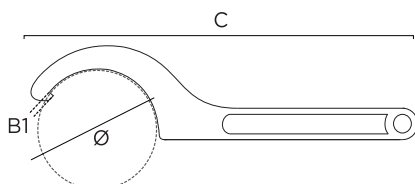

Codice	Ø mm	B1 mm	C mm	gr		Barcode
441203	25 x 28	1,8	136	50	5	8033183570468
441204	30 x 32	2,1	136	50	5	8033183570475
441205	34 x 36	2,4	170	95	5	8033183570499
441206	40 x 42	2,4	170	95	5	8033183562371
441207	45 x 50	2,5	205	150	5	8033183562388
441208	52 x 55	2,5	205	150	5	8033183562395
441209	58 x 62	2,5	240	220	5	8033183562401
441210	68 x 75	3,1	240	220	5	8033183557940
441211	80 x 90	3,8	280	370	3	8033183558664
441212	98 x 100	4,3	280	370	3	8033183562418
441213	110 x 115	4,4	320	740	2	8033183562364
441214	120 x 130	4,9	320	740	2	8033183557926

441403 CHIAVI A SETTORE NASELLO TONDO

ROUND NOSE SECTOR KEYS

Disponibile su richiesta fino a 180 x 195mm
Available on request up to 180 x 195mm

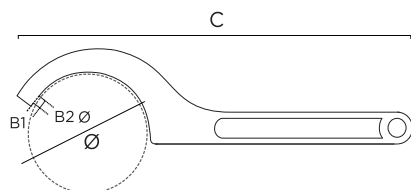

Codice	Ø mm	B1 mm	B2 mm	C mm	gr		Barcode
441403	25 x 28	3,0	3,0	136	50	5	8033183570505
441404	30 x 32	3,0	4,0	136	50	5	8033183559869
441405	34 x 36	3,5	4,0	170	95	5	8033183570512
441406	40 x 42	3,5	4,0	170	95	5	8033183559876
441407	45 x 50	4,0	5,0	205	150	5	8033183559883
441408	52 x 55	4,0	5,0	205	150	5	8033183559890
441409	58 x 62	5,0	5,0	240	220	5	8033183559906
441410	68 x 75	5,0	6,0	240	220	5	8033183559913
441411	80 x 90	6,0	6,0	280	370	3	8033183559920
441412	98 x 100	6,0	8,0	280	370	3	8033183559937
441413	110 x 115	8,0	8,0	320	740	2	8033183559944
441414	120 x 130	8,0	8,0	320	740	2	8033183559333

441501 CHIAVI A SETTORE SNODATE NASELLO QUADRO
 ARTICULATED SECTOR KEYS WITH SQUARE NOSE

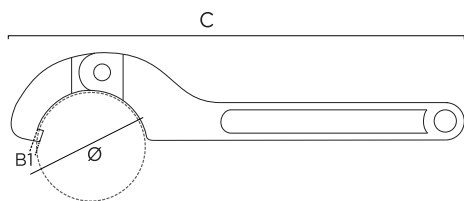

Codice	Ø mm	B1 mm	C mm		Barcode
441501	15 x 35	2,7	170	3	8033183558978
441502	35 x 50	3,5	210	3	8033183558985
441503	50 x 80	4,7	280	3	8033183558992
441504	80 x 120	6,2	345	2	8033183559005
441505	120 x 180	7,8	475	2	8033183559012

441601 CHIAVI A SETTORE SNODATE NASELLO TONDO
 ARTICULATED SECTOR KEYS ROUND NOSE

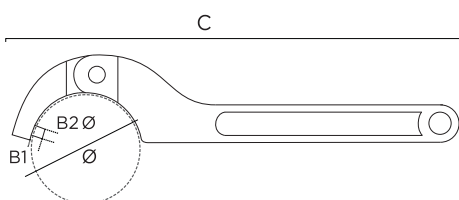

Codice	Ø mm	B1 mm	B2 mm	C mm		Barcode
441601	15 x 35	2,5	3,0	170	3	8033183568168
441602	35 x 50	3,5	4,0	210	3	8033183562784
441603	50 x 80	5,0	5,0	280	3	8033183561381
441604	80 x 120	7,0	6,0	345	2	8033183561398
441605	120 x 180	9,0	8,0	475	2	8033183570529

Chiavi maschio

Male keys

240001 CHIAVI MASCHIO ESAGONALI PIEGATE CORTE BENT MALE WRENCHES WITH HANDLE

- Impronta esagonale
Hexagonal footprint
- In acciaio al cromo vanadio con esecuzione nichelata
In chrome vanadium steel with nickel-plated execution



Codice	∅ mm	mm	gr		Barcode
240001	1,5	46	1	100	8033116540582
240002	2,0	51	2	100	8033116530637
240003	2,5	58	3	100	8033116530644
240004	3,0	65	5	100	8033116530651
240005	3,5	75	7	50	8033116530668
240006	4,0	72	11	50	8033116530675
240007	4,5	78	15	50	8033116530682
240008	5,0	84	20	50	8033116530699
240009	6,0	90	31	50	8033116530705
240010	7,0	100	45	50	8033116530712

Codice	∅ mm	mm	gr		Barcode
240011	8,0	107	63	50	8033116530729
240012	9,0	112	83	50	8033116530736
240013	10,0	120	111	50	8033116530743
240014	12,0	135	179	50	8033116540599
240015	13,0	143	230	50	8033116540605
240016	14,0	152	277	5	8033116540612
240017	17,0	173	462	5	8033116540629
240018	19,0	195	645	5	8033116540636
240019	22,0	210	953	5	8033116540643

240501 SERIE CHIAVI MASCHIO ESAGONALI PIEGATE CORTE SET OF HEXAGONAL MALE WRENCHES SHORT BENT

In busta di plastica / *In plastic bag*

Codice	Pezzi / Pieces		gr		Barcode
240501	8	240001 - 02 - 03 - 04 - 05 - 06 - 08 - 09	90	5	8033116540650
240601	12	240001 - 02 - 03 - 04 - 05 - 06 - 08 - 09 - 10 - 11 - 12 - 13	400	5	8033116531115



240801 SERIE CHIAVI MASCHIO ESAGONALI PIEGATE CORTE SET OF HEXAGONAL MALE WRENCHES SHORT BENT

In anello portachiaavi / *In key ring*

Codice	Pezzi / Pieces		gr		Barcode
240801	7	240002 - 04 - 06 - 08 - 09 - 11 - 13	260	5	8033116531771



240901 CHIAVI MASCHIO ESAGONALI PIEGATE LUNGHE LONG BENT HEXAGONAL MALE WRENCHES

- Impronta esagonale
Hexagonal print
- In acciaio con finitura brunita
Steel with burnished finish



Codice	Ø mm	mm	gr		Barcode
240901	2,0	90	3	20	8033116540667
240902	2,5	110	5	20	8033116540674
240903	3,0	125	9	20	8033116540681
240904	3,5	130	13	20	8033116540698
240905	4,0	150	18	20	8033116540704
240906	4,5	150	25	20	8033116540711
240907	5,0	150	32	20	8033116540728

Codice	Ø mm	mm	gr		Barcode
240908	6,0	200	55	10	8033116540735
240909	7,0	200	74	10	8033116540742
240910	8,0	200	102	10	8033116540759
240911	9,0	200	135	10	8033116540766
240912	10,0	200	180	10	8033116540773
240913	11,0	250	250	10	8033116540780

241001 SERIE CHIAVI MASCHIO ESAGONALI PIEGATE LUNGHE LONG BENT HEXAGONAL MALE WRENCHES SET

In busta di plastica / *In plastic bag*

Codice	Pezzi / Pieces	gr		Barcode	
241001	7	240901 - 02 - 03 - 05 - 07 - 08 - 10 - 12	460	1	8033116540797



241106 CHIAVI MASCHIO "TORX" PIEGATE BENT TORX MALE WRENCHES

- Impronta a croce "Torx"
"Torx" cross recess
- In acciaio con finitura brunita
Steel with burnished finish

Codice	Ø mm	mm	gr		Barcode
241106	TX 6	42	2	10	8033116540803
241107	TX 7	48	3	10	8033116540810
241108	TX 8	48	3	10	8033116540827
241109	TX 9	48	4	10	8033116540834
241110	TX 10	51	4	10	8033116540841
241115	TX 15	54	5	10	8033116540858
241120	TX 20	57	7	10	8033116540865
241125	TX 25	60	10	10	8033116540872
241127	TX 27	63	16	10	8033116540889
241130	TX 30	70	20	5	8033116540896
241140	TX 40	76	30	5	8033116540902
241145	TX 45	82	43	5	8033116540919



241301 SERIE CHIAVI MASCHIO "TORX" "TORX" MALE KEY SERIES

In busta di plastica / *In plastic bag*

Codice	Pezzi / Pieces	gr		Barcode	
241301	12	241106 - 07 - 08 - 09 - 10 - 15 20 - 25 - 27 - 30 - 40 - 45	200	5	8033116540988



241201 SERIE CHIAVI MASCHIO "TORX"
"TORX" MALE KEY SERIES

Codice	Pezzi / Pieces		gr		Barcode
241201	7	T40 - T30 - T27 - T25 - T20 T15 - T10	90	5	8033116540971



240301 CHIAVI MASCHIO PIEGATE COLORATE
COLORED FOLDED MALE KEYS

- ♦ Testa esagonagonale + estremità sferica
Hex head + ball end
- ♦ Impugnatura rivestita in materiale antiscivolo
Anti-slip handle
- ♦ L'impugnatura colorata identifica la misura
Color of the handle identifies the size
- ♦ L'estremità sferica consente di operare con un'inclinazione fino a 30°
The spherical end allows you to operate with an inclination of up to 30°

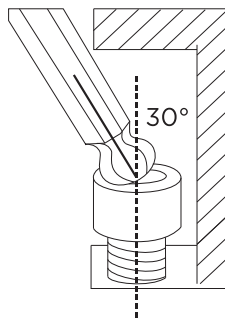





Codice		Ø mm	mm		Barcode
240301	Verde / Green	1,5	92	10	8033183560155
240302	Giallo / yellow	2,0	102	10	8033183560162
240303	Verde brillante / Bright green	2,5	115	10	8033183560179
240304	Blu brillante / Bright blue	3,0	129	10	8033183560186
240305	Viola / Purple	4,0	144	10	8033183560193
240306	Rosso / Red	5,0	165	10	8033183560209
240307	Arancio / Orange	6,0	186	10	8033183560216
240308	Blu / Blue	8,0	208	10	8033183562265
240309	Nero / Black	10,0	234	10	8033183562357



240401 SET CHIAVI MASCHIO PIEGATE COLORATE
COLORED FOLDED MALE KEYS SET

- ♦ Supporto in plastica con sistema di bloccaggio delle chiavi
Plastic holder with key locking system

Codice	Pezzi / Pieces	Ø mm			Barcode
240401	9	1,5 - 2 - 2,5 - 3 - 4 - 5 - 6 - 8 - 10		6	8033183559593
240402	9	1,5 - 2 - 2,5 - 3 - 4 - 5 - 6 - 8 - 10		6	8033183556882
240403	9	TX10 - TX15 - TX20 - TX25 - TX27 - TX30 - TX40 - TX45 - TX50		6	8033183556875
240404	9	TX10 - TX15 - TX20 - TX25 - TX27 - TX30 - TX40 - TX45 - TX50		6	8033183556851
240410	16	Espositore / Exhibitor 4 x 240401 - 02 - 03 - 04		1	8033183559074



241901 SET CHIAVI PIEGATE MASCHIO MALE FOLDED WRENCH SET

- In acciaio al cromo vanadio con esecuzione cromata sabbata
In chrome vanadium steel with sandblasted chrome finish
- Supporto in plastica con sistema di bloccaggio delle chiavi
Plastic holder with key locking system



Codice	Pezzi / Pieces	Ø mm			Barcode
241901	6	2 - 2,5 - 3 - 4 - 5 - 6	⊙	2	8033116540995
241912	8	2 - 2,5 - 3 - 4 - 5 - 6 - 8 - 10	⊙	2	8033116541008
241913	6	Extra long: 2 - 2,5 - 3 - 4 - 5 - 6	⊙	2	8033116541015
241914	8	Extra long: 2 - 2,5 - 3 - 4 - 5 - 6 - 8 - 10	⊙	2	8033116541022
241905	6	Long: TX10 - TX15 - TX20 - TX25 - TX30 - TX40	⊕	2	8033116541039
241906	6	Long: TX10 - TX15 - TX20 - TX25 - TX30 - TX40	⊕	2	8033116541046

241920 SET CHIAVI MASCHIO PIEGATE CON SUPPORTO SET MALE WRENCHES WITH SUPPORT

- In acciaio al cromo vanadio con esecuzione cromata sabbata
In chrome vanadium steel with sandblasted chrome finish
- Supporto tascabile in materiale plastico antiurto
Pocket support in shockproof plastic material



Codice	Pezzi / pieces	Ø mm			Barcode
241920	7	1,5 - 2 - 2,5 - 3 - 4 - 5 - 6	⊙	2	8033116541237
241921	7	1,5 - 2 - 2,5 - 3 - 4 - 5 - 6	⊕	2	8033116541244
241922	7	TX10 - TX15 - TX20 - TX25 - TX27 - TX30 - TX40	⊕	2	8033116541251
241923	7	TX10 - TX15 - TX20 - TX25 - TX27 - TX30 - TX40	⊕	2	8033116541268

241500 CHIAVI MASCHIO PIEGATE CON IMPUGNATURA BENT MALE WRENCHES WITH HANDLE

- Impronta esagonale
Hexagonal footprint
- In acciaio al cromo vanadio con esecuzione cromata sabbata
In chrome vanadium steel with sandblasted chrome finish
- Impugnatura ergonomica bimateriale con rivestimento antiscivolo
Pocket support in shockproof plastic material

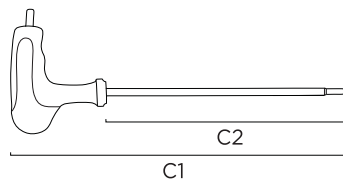

Codice	Ø mm	C1 mm	C2 mm	gr		Barcode
241500	2,0	140	100	18	5	8033183555199
241501	2,5	140	100	18	5	8033116530750
241502	3,0	140	100	18	5	8033116530767
241504	4,0	140	100	58	5	8033116530781
241505	4,5	190	150	62	5	8033116530798
241506	5,0	210	150	65	5	8033116530804
241507	6,0	210	150	110	5	8033116530811
241508	7,0	235	195	117	5	8033116530828
241509	8,0	260	200	125	5	8033116530835
241510	10,0	275	200	192	5	8033116530842



241720 CHIAVI MASCHIO PIEGATE CON IMPUGNATURA BENT MALE WRENCHES WITH HANDLE

- Testa a impronta esagonale + estremità lunga brunita sferica
Hex head + spherical long end
- In acciaio al cromo vanadio con esecuzione cromata sabbata
In chrome vanadium steel with sandblasted chrome finish
- Impugnatura ergonomica bimateriale con rivestimento antiscivolo
Pocket support in shockproof plastic material
- L'estremità sferica consente di operare con un'inclinazione fino a 30°
The spherical end allows you to operate with an inclination of up to 30°

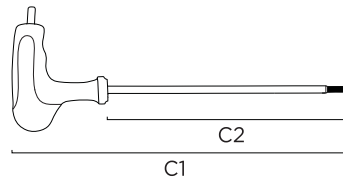
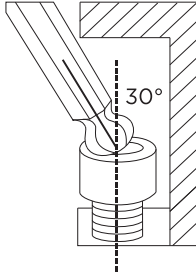

Codice	Ø mm	C1 mm	C2 mm	gr	📦	Barcode
241720	2,0	140	100	18	5	8033116541053
241725	2,5	140	100	18	5	8033116541060
241730	3,0	140	100	18	5	8033116541077
241740	4,0	190	200	34	5	8033116541084
241750	5,0	210	150	66	5	8033116541091
241760	6,0	230	170	78	5	8033116541107
241780	8,0	260	200	153	5	8033116541114
241710	10,0	275	200	271	5	8033116541121
241706	Set 6 pz. in valigetta / Case with 6 keys set 241725 - 30 - 40 - 50 - 60 - 80				1	8033183552402



05

241810 CHIAVI MASCHIO PIEGATE CON IMPUGNATURA BENT MALE WRENCHES WITH HANDLE

- Testa a impronta torx + estremità brunita torx con foro
Torx head + torx end with hole
- In acciaio al cromo vanadio con esecuzione cromata sabbata
In chrome vanadium steel with sandblasted chrome finish
- Impugnatura ergonomica bimateriale con rivestimento antiscivolo
Pocket support in shockproof plastic material

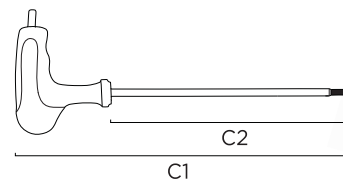

Codice	Ø mm	C1 mm	C2 mm	gr	📦	Barcode
241810	TX10	140	100	26	5	8033116541138
241815	TX15	140	100	26	5	8033116541145
241820	TX20	140	100	26	5	8033116541152
241825	TX25	205	150	79	5	8033116541169
241827	TX27	205	150	79	5	8033116541176
241830	TX30	205	150	79	5	8033116541183
241840	TX40	260	200	139	5	8033116541190
241845	TX45	260	200	139	5	8033116541206
241850	TX50	275	200	328	5	8033116541213
241806	Set 6 pz. in valigetta / Case with 6 keys set 241825 - 30 - 40 - 50 - 60 - 80				1	8033116541220



Chiavi a "T"

"T" keys

380001 CHIAVI A "T" CON MASCHIO ESAGONALE T-WRENCHES WITH HEXAGONAL MALE

- In acciaio al cromo vanadio con testa nera
Chrome vanadium steel with black head
- Asta di manovra fissa
Fixed operating rod

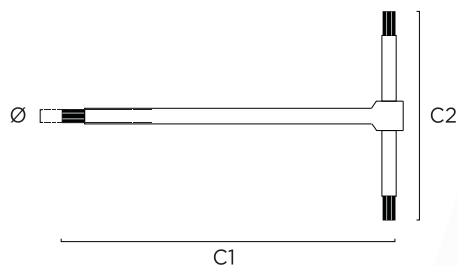

Codice		Ø mm	C1 mm	C2 mm		Barcode
380001	Testa nera / Black head	2,0	125	62	10	8033116542883
380002	Testa nera / Black head	2,5	125	62	10	8033116542890
380003	Testa nera / Black head	3	126	62	10	8033116542906
380004	Testa nera / Black head	3,5	127	64	10	8033116542913
380005	Testa nera / Black head	4,0	181	85	10	8033116542920
380006	Testa nera / Black head	4,5	185	90	10	8033116542937
380007	Testa nera / Black head	5,0	185	90	10	8033116542944
380008	Testa nera / Black head	6,0	210	100	10	8033116542951
380009	Testa nera / Black head	7,0	212	105	10	8033116542968
380010		8,0	252	125	10	8033116542975
380011		9,0	300	145	10	8033116542982
380012		10,0	302	150	10	8033116542999
380013		11,0	322	166	10	8033116543002
380014		12,0	344	172	10	8033116543019

380801 SERIE CHIAVI A "T" CON MASCHIO ESAGONALE SERIES "T" KEYS WITH HEXAGONAL MALE

Scatola / Box

Codice	Pezzi / Pieces			Barcode
380801	8	380001 - 02 - 03 - 04 - 05 - 07 - 08 - 10 - 12	1	8033116543026
381401	14	380001 - 02 - 03 - 04 - 05 - 06 - 07 - 08 - 09 - 10 - 11 - 12 - 13 - 14	1	8033116543033



380001S CHIAVI A "T" CON MASCHIO ESAGONALE T-WRENCHES WITH HEXAGONAL MALE

- ◆ In acciaio al cromo vanadio con testa nera
Chrome vanadium steel with black head
- ◆ Asta di manovra scorrevole
Sliding operating rod

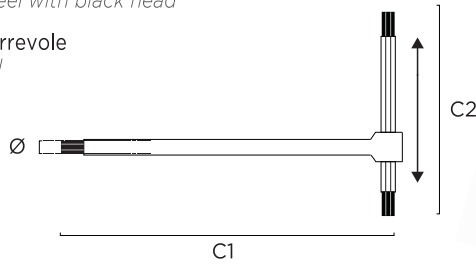

C2

C1



Codice		Ø mm	C1 mm	C2 mm		Barcode
380001S	Testa nera / Black head	2,0	125	62	10	8033183553904
380002S	Testa nera / Black head	2,5	125	62	10	8033183553911
380003S	Testa nera / Black head	3,0	126	62	10	8033183553881
380004S	Testa nera / Black head	3,5	127	64	10	8033183553959
380005S	Testa nera / Black head	4,0	181	85	10	8033183553928
380006S	Testa nera / Black head	4,5	185	90	10	8033183553966
380007S	Testa nera / Black head	5,0	185	90	10	8033183553935

Codice		Ø mm	C1 mm	C2 mm		Barcode
380008S	Testa nera / Black head	6,0	210	100	10	8033183553836
380009S	Testa nera / Black head	7,0	212	105	10	8033183554499
380010S		8,0	252	121	10	8033183553829
380012S		10,0	302	150	10	8033183553867
380013S		12,0	322	166	10	8033183553850
380014S		14,0	344	172	10	8033183553874

380801S SERIE CHIAVI A "T" CON MASCHIO ASTA SCORREVOLE SERIES "T" KEYS WITH MALE SLIDING ROD

Scatola / box

Codice	Pezzi / Pieces			Barcode
380801S	8	380001S - 02 - 03 - 04 - 05 - 07 - 08 - 10 - 12	1	8033183553942
381401A	13	380001S - 02 - 03 - 04 - 05 - 06 - 07 - 08 - 09 - 10 - 12 - 13 - 14	1	8033183561817



380108 CHIAVI A "T" MASCHIO "TORX" "TORX" MALE "T" WRENCHES

- ◆ In acciaio al cromo vanadio con testa nera
Chrome vanadium steel with black head
- ◆ Asta di manovra fissa
Fixed operating rod

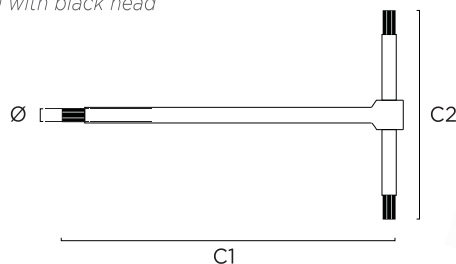

C2

C1



Codice		Ø mm	C1 mm	C2 mm		Barcode
380108	Testa nera / Black head	TX 8	127	65	3	8033116543163
380109	Testa nera / Black head	TX 9	125	65	3	8033116543170
380110	Testa nera / Black head	TX 10	127	65	3	8033116543187
380115	Testa nera / Black head	TX 15	127	65	3	8033116543194
380120	Testa nera / Black head	TX 20	127	65	3	8033116543200
380125	Testa nera / Black head	TX 25	185	90	3	8033116543217
380127	Testa nera / Black head	TX 27	185	90	3	8033116543224
380130	Testa nera / Black head	TX 30	185	90	3	8033116543231
380140		TX 40	213	105	2	8033116543248
380145		TX 45	212	107	2	8033116543255

380210 SERIE CHIAVI A "T" MASCHIO "TORX"
 "TORX" MALE "T" KEY SERIES

Scatola / Box

Codice	Pezzi / Pieces		Barcode
380210	10	380108 - 09 - 10 - 15 - 20 - 25 - 27 - 30 - 40 - 45	8033183561879



380109S CHIAVI A "T" MASCHIO "TORX"
 "TORX" MALE "T" WRENCHES

- In acciaio al cromo vanadio con testa nera
 Chrome vanadium steel with black head

- Asta di manovra scorrevole
 Sliding operating rod

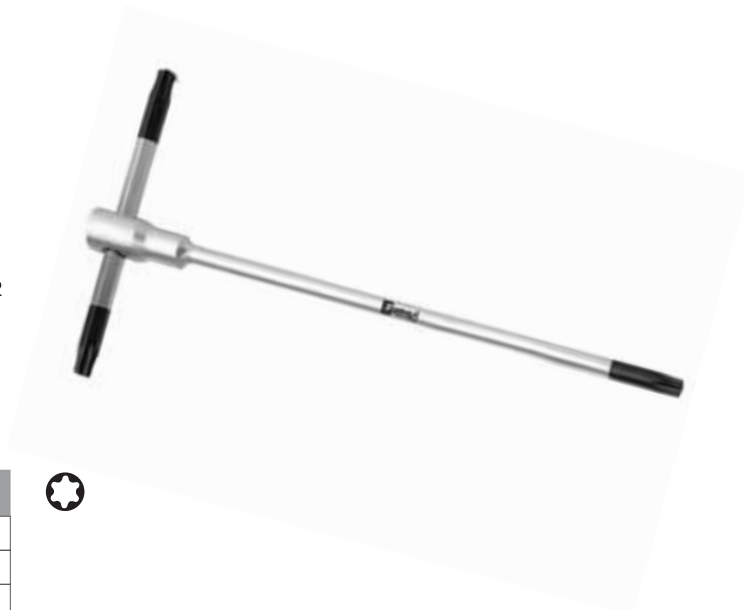
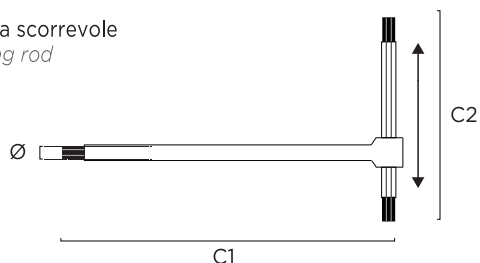

Codice		Ø mm	C1 mm	C2 mm		Barcode
380109S	Testa nera / Black head	TX 9	125	65	3	8033183556332
380110S	Testa nera / Black head	TX 10	127	65	3	8033183556363
380115S	Testa nera / Black head	TX 15	127	65	3	8033183556714
380120S	Testa nera / Black head	TX 20	127	65	3	8033183556325
380125S	Testa nera / Black head	TX 25	185	90	3	8033183554918
380127S	Testa nera / Black head	TX 27	185	90	3	8033183567024
380130S	Testa nera / Black head	TX 30	185	90	3	8033183556349
380140S		TX 40	213	105	2	8033183556356
380145S		TX 45	212	107	2	8033183567017

380809S SERIE CHIAVI A "T" MASCHIO "TORX" ASTA SCORREVOLE
 MALE "TORX" MALE T-SHAPED KEYS SLIDING ROD

Scatola / Box

Codice	Pezzi / Pieces		Barcode
380809S	9	380109S - 10S - 15S - 20S - 25S - 27S - 30S - 40S - 45S	8033183554574



400006 CHIAVI A "T" SEMPLICE ESAGONALE SIMPLE HEXAGONAL "T" WRENCHES

- In acciaio al cromo vanadio
Chrome vanadium steel
- Asta di manovra scorrevole ed estraibile
Sliding and removable operating rod

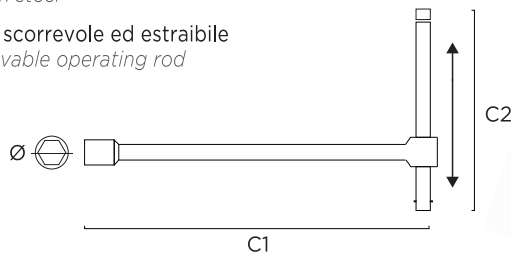

Codice	Ø mm	C1 mm	C2 mm		Barcode
400006	6,0	215	130	4	8033116530859
400007	7,0	215	145	4	8033116530866
400008	8,0	235	165	4	8033116530873
400010	10,0	240	180	4	8033116530897
400011	11,0	260	200	4	8033116530903
400012	12,0	260	200	4	8033116530910
400013	13,0	260	180	4	8033116530927
400014	14,0	270	220	4	8033116542456
400015	15,0	270	220	4	8033116542463
400016	16,0	270	220	4	8033116542470
400017	17,0	240	230	4	8033116542487

Codice	Ø mm	C1 mm	C2 mm		Barcode
400018	18,0	285	240	4	8033116542494
400019	19,0	300	240	4	8033116542500
400020	20,0	310	260	4	8033116542517
400021	21,0	310	260	4	8033116542524
400022	22,0	310	260	4	8033116542531
400023	23,0	310	260	1	8033116542548
400024	24,0	315	330	1	8033116542555
400025	25,0	315	330	1	8033116542562
400027	27,0	315	330	1	8033116542586
400030	30,0	320	455	1	8033116542609
400032	32,0	320	455	1	8033116542616

401701 SERIE CHIAVI A "T" SEMPLICE ESAGONALE SIMPLE HEXAGONAL "T" KEY SERIES

Scatola / Box

Codice	Pezzi / Pieces			Barcode
401701	16	400006 - 07 - 08 - 10 - 11 - 12 - 13 - 14 - 15 - 16 - 17 - 18 - 19 - 20 - 21 - 22	1	8033116542623
402601	22	400006 - 07 - 08 - 10 - 11 - 12 - 13 - 14 - 15 - 16 - 17 - 18 - 19 - 20 - 21 - 22 - 23 - 24 - 25 - 27 - 30 - 32	1	8033116542630



405006 CHIAVI A "T" SEMPLICE ESAGONALE CORTA SIMPLE HEXAGONAL "T" WRENCHES

- In acciaio al cromo vanadio
Chrome vanadium steel
- Asta di manovra scorrevole
Sliding operating rod

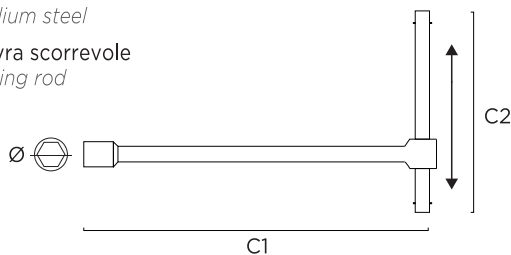



Codice	Ø mm	C1 mm	C2 mm		Barcode
405004	4,0	65	50	10	8033183561756
405005	5,0	70	60	10	8033183561763
405006	6,0	75	70	10	8033183556516
405007	7,0	80	80	10	8033183556523
405008	8,0	95	85	10	8033183556530
405009	9,0	105	90	10	8033183556769

Codice	Ø mm	C1 mm	C2 mm		Barcode
405010	10,0	115	105	10	8033183556547
405011	11,0	125	105	10	8033183556554
405012	12,0	135	120	10	8033183556509
405013	13,0	145	125	10	8033183556561
405014	14,0	170	155	10	8033183561770

410007 CHIAVI A "T" ESAGONALE A SNODO HEXAGONAL JOINT "T" WRENCHES

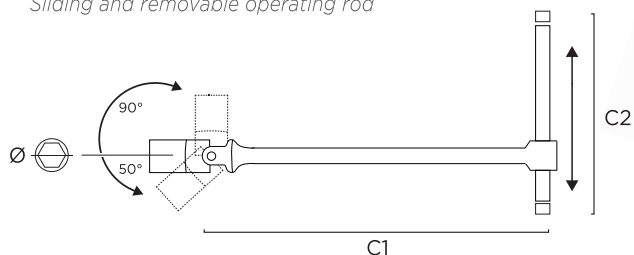
- In acciaio al cromo vanadio
Chrome vanadium steel
- Asta di manovra scorrevole ed estraibile
Sliding and removable operating rod



Codice	Ø mm	C1 mm	C2 mm		Barcode
410007	7,0	400	165	4	8033116542647
410008	8,0	470	180	4	8033116542654
410009	9,0	400	145	4	8033116542661
410010	10,0	450	180	4	8033116530934
410011	11,0	405	160	4	8033116542678
410012	12,0	495	200	4	8033116542685
410013	13,0	495	200	4	8033116530941
410014	14,0	505	200	4	8033116542692
410015	15,0	400	200	4	8033116542708
410016	16,0	445	200	4	8033116542715
410017	17,0	445	200	4	8033116542722
410018	18,0	450	200	4	8033116542739
410019	19,0	505	230	4	8033116542746
410020	20,0	505	230	4	8033116542753
410021	21,0	520	220	4	8033116542760
410022	22,0	510	220	4	8033116542777
410024	24,0	510	230	4	8033116542791

411701 SERIE CHIAVI A "T" A SNODO SWIVEL "T" WRENCH SERIES

Scatola / box

Codice	Pezzi / Pieces		Barcode
411701	7	400008 - 10 - 13 - 16 - 17 - 18 - 19	1 8033116542814
410701	17	400007 - 08 - 09 - 10 - 11 - 12 - 13 - 14 - 15 - 16 - 17 - 18 - 19 - 20 - 21 - 22 - 24	1 8033116542807





Chiavi a tubo

Pipe wrenches

430001 CHIAVI A TUBO DOPPIE PROFESSIONALI PROFESSIONAL DOUBLE SOCKET WRENCHES

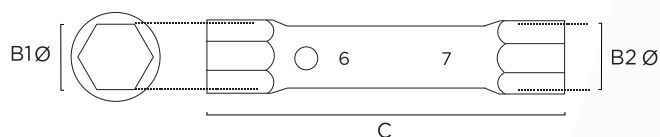
- In acciaio al cromo molibdeno con esecuzione cromata
In chromium molybdenum steel with chromed execution



Codice	B1 X B2 mm	C mm	gr		Barcode
430001	6 x 7	110	38	6	8033116541350
430002	8 x 9	110	42	6	8033116541367
430003	10 x 11	122	72	6	8033116541374
430004	12 x 13	140	93	6	8033116541381
430005	14 x 15	140	95	6	8033116541398
430006	16 x 17	152	124	6	8033116541404
430007	18 x 19	162	172	6	8033116541411
430008	20 x 22	172	253	6	8033116541428
430009	21 x 23	172	222	4	8033116541435
430010	24 x 26	195	407	4	8033116541442
430011	25 x 28	192	394	4	8033116541459
430012	27 x 29	200	414	4	8033116541466
430013	30 x 32	205	450	4	8033116541473



430801 SERIE CHIAVI A TUBO DOPPIE PROFESSIONALI PROFESSIONAL DOUBLE SOCKET WRENCH SERIES

Scatola / Box

Codice	Pezzi / Pieces	gr		Barcode	
430801	8	430001 - 02 - 03 - 04 - 05 - 06 07 - 08	900	1	8033116533645
431201	12	430001 - 02 - 03 - 04 - 05 - 06 07 - 08 - 09 - 10 - 11 - 13	2550	1	8033116541480
431301	13	430001 - 02 - 03 - 04 - 05 - 06 07 - 08 - 09 - 10 - 11 - 12 - 13	3050	1	8033116541497



431001 CHIAVI A TUBO DOPPIE DOUBLE SOCKET WRENCHES

- In acciaio al cromo molibdeno con esecuzione zincata
In chromium molybdenum steel with galvanized execution
- Modello leggero
Lightweight model

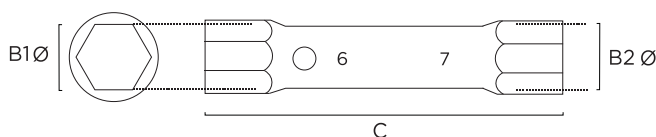

Codice	B1 X B2 mm	C mm	gr		Barcode
431001	6 x 7	95	35	10	8033183554086
431002	8 x 9	95	38	10	8033183554093
431003	10 x 11	105	45	10	8033183554109
431004	12 x 13	110	52	10	8033183554116
431005	14 x 15	115	72	10	8033183554895
431006	16 x 17	115	80	10	8033183555076
431007	18 x 19	130	96	10	8033183554666
431008	20 x 22	135	153	10	8033183555083
431009	21 x 23	140	170	10	8033183554659

Codice	B1 X B2 mm	C mm	gr		Barcode
431010	24 x 26	145	186	10	8033183556202
431011	25 x 28	160	249	10	8033183556219
431012	27 x 29	191	249	10	8033183557551
431013	30 x 32	165	320	10	8033183564931
431014	40 x 46	195	500	5	8033183554765
431015	46 x 50	200	600	5	8033183554772
431016	50 x 55	200	600	5	8033183554789
431017	55 x 60	210	600	5	8033183554796
431018	55 x 55	200	600	5	8033183554802

435001 CHIAVI A TUBO DOPPIE PESANTI HEAVY DOUBLE SOCKET WRENCHES

- In acciaio al cromo vanadio con esecuzione cromata
In chrome vanadium steel with chrome finish
- Modello pesante
Heavy model

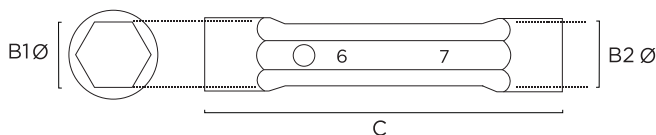

Codice	B1 X B2 mm	C mm	gr		Barcode
435001	6 x 7	105	41	6	8033116541794
435002	8 x 9	110	54	6	8033116541800
435003	10 x 11	120	75	6	8033116541817
435004	12 x 13	135	102	6	8033116541824
435005	14 x 15	145	150	6	8033116541831
435006	16 x 17	155	184	6	8033116541848
435007	18 x 19	165	266	6	8033116541855

Codice	B1 X B2 mm	C mm	gr		Barcode
435008	20 x 22	175	322	6	8033116541862
435009	21 x 23	183	358	4	8033116541879
435010	24 x 26	193	438	4	8033116541886
435011	25 x 28	203	535	4	8033116541893
435012	27 x 29	205	592	4	8033116541909
435013	30 x 32	208	737	4	8033116541916

435101 SERIE CHIAVI A TUBO DOPPIE PESANTI HEAVY DOUBLE TUBE WRENCHES SERIES

Scatola / Box

Codice	Pezzi / Pieces	gr		Barcode
435101	8	435001 - 02 - 03 - 04 - 05 - 06 07 - 08	1	8033116541923
435301	13	435001 - 02 - 03 - 04 - 05 - 06 07 - 08 - 09 - 10 - 11 - 12 - 13	1	8033116541947



435303 SERIE CHIAVI A TUBO DOPPIE PESANTI HEAVY DOUBLE TUBE WRENCHES SERIES

Supporto in lamiera / Sheet metal support

Codice	Pezzi / pieces		gr		Barcode
435303	13	435001 - 02 - 03 - 04 - 05 - 06 07 - 08 - 09 - 10 - 11 - 12 - 13	4800	1	8033183570451



44401 SPINA DI MANOVRA PER CHIAVE A TUBO MANEUVER PIN FOR TUBE WRENCH

- ◆ In acciaio al cromo vanadio con esecuzione cromata
In chrome vanadium steel with chrome finish
- ◆ I gradini consentono di usare una sola spina per chiavi a tubo di varie misure
The steps allow you to use a single pin for socket wrenches of various sizes

Codice	mm	gr		Barcode
444001	6 - 23	80	1	8033116541770
444002	24 - 32	280	1	8033116541787

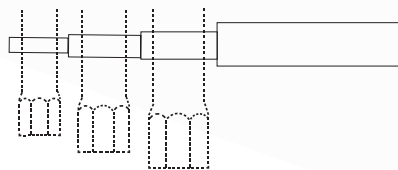

441006 CHIAVI A TUBO A PIPA PIPE WRENCHES

- ◆ In acciaio al cromo vanadio con esecuzione zincata
Chrome vanadium steel with galvanized finish
- ◆ Modello leggero
Lightweight model

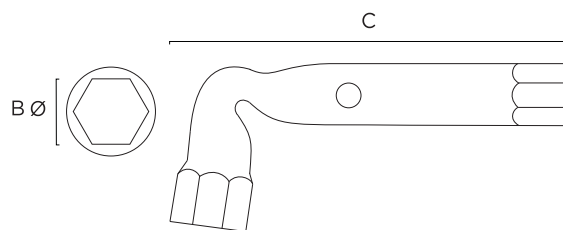



Codice	Ø mm	C mm	gr		Barcode
441006	6,0	80	29	10	8033183559692
441007	7,0	80	32	10	8033183560612
441008	8,0	85	42	10	8033183556158
441009	9,0	90	44	10	8033183560575
441010	10,0	90	50	10	8033183556431
441011	11,0	95	90	10	8033183559647
441012	12,0	100	108	10	8033183553621
441013	13,0	100	108	10	8033183556424
441014	14,0	105	108	10	8033183559685

Codice	Ø mm	C mm	gr		Barcode
441015	15,0	110	108	10	8033183559678
441016	16,0	120	126	10	8033183560629
441017	17,0	125	130	10	8033183556592
441018	18,0	125	152	10	8033183559661
441019	19,0	140	152	10	8033183560636
441020	20,0	140	205	10	8033183560643
441021	21,0	145	205	10	8033183559654
441022	22,0	145	240	10	8033183560650

445006 CHIAVI A TUBO A PIPA PROFESSIONALI PROFESSIONAL PIPE WRENCHES

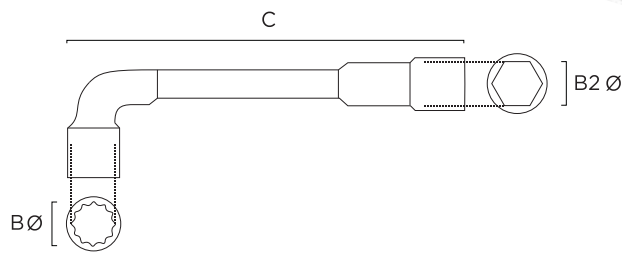
- In acciaio al cromo vanadio con esecuzione cromata
Chrome vanadium steel with chrome finish
- Modello pesante
Heavy model



Codice	B1 X B2 mm	C mm	gr		Barcode
445006	6 x 6	95	30	6	8033116541954
445007	7 x 7	95	40	6	8033116541961
445008	8 x 8	110	50	6	8033116541978
445009	9 x 9	115	70	6	8033116541985
445010	10 x 10	130	80	6	8033116541992
445011	11 x 11	130	110	6	8033116542005
445012	12 x 12	145	155	6	8033116542012
445013	13 x 13	150	175	6	8033116542029
445014	14 x 14	170	200	6	8033116542036
445015	15 x 15	180	225	6	8033116542043
445016	16 x 16	195	290	6	8033116542050
445017	17 x 17	200	300	6	8033116542067
445018	18 x 18	200	340	6	8033116542074

Codice	B1 X B2 mm	C mm	gr		Barcode
445019	19 x 19	220	370	6	8033116542081
445020	20 x 20	220	450	6	8033116542098
445021	21 x 21	220	460	6	8033116542104
445022	22 x 22	250	520	6	8033116542111
445023	23 x 23	240	600	6	8033116542128
445024	24 x 24	240	620	6	8033116542135
445025	25 x 25	260	660	6	8033116542142
445026	26 x 26	270	765	6	8033116542159
445027	27 x 27	275	860	6	8033183554758
445028	28 x 28	270	950	6	8033116542166
445030	30 x 30	320	1100	6	8033116542173
445032	32 x 32	350	1400	6	8033116542180

445101 SERIE CHIAVI A TUBO A PIPA PROFESSIONALI PROFESSIONAL PIPE WRENCH SERIES

Scatola / Box

Codice	Pezzi / Pieces	gr		Barcode	
445101	17	445006 - 07 - 08 - 09 - 10 - 11 - 12 - 13 - 14 - 15 - 16 - 17 - 18 - 19 - 20 - 21 - 22	3910	1	8033116542197
445201	25	445006 - 07 - 08 - 09 - 10 - 11 - 12 - 13 - 14 - 15 - 16 - 17 - 18 - 19 - 20 - 21 - 22 - 23 - 24 - 25 - 26 - 27 - 28 - 29 - 30	3800	1	8033116542203



Chiavi a bussola

Socket wrenches

245905 CHIAVI A BUSSOLA BOCCA ESAGONALE HEXAGONAL MOUTH SOCKET WRENCH

- In acciaio al cromo vanadio con esecuzione cromata sabbata
Chrome vanadium steel with sandblasted chrome finish
- Impugnatura ergonomica in bimateriale
Ergonomic bi-material handle

Codice	Ø mm	mm	gr		Barcode
245905	6	260	65	6	8033116542258
245906	7	260	100	6	8033116542265
245907	8	260	110	6	8033116542272
245908	9	260	110	6	8033116542289
245909	10	260	110	6	8033116542296



Codice	Ø mm	mm	gr		Barcode
245910	11	260	180	6	8033116542302
245911	12	260	185	6	8033116542319
245912	13	260	185	6	8033116542326
245913	14	260	190	6	8033116542333
245914	15	260	195	6	8033116542340

245923 CHIAVI A BUSSOLA BOCCA ESAGONALE LUNGA SOCKET WRENCHES, LONG HEXAGONAL MOUTH

- In acciaio al cromo vanadio con esecuzione cromata sabbata
Chrome vanadium steel with sandblasted chrome finish
- Impugnatura ergonomica in bimateriale
Ergonomic bi-material handle

Codice	Ø mm	mm	gr		Barcode
245923	7	260	110	6	8033116542388
245924	8	260	125	6	8033116531757
245925	9	260	125	6	8033116542395
245926	10	260	130	6	8033116542401



Codice	Ø mm	mm	gr		Barcode
245927	11	260	190	6	8033116542418
245928	12	260	200	6	8033116542425
245929	13	260	200	6	8033116542432
245930	14	260	220	6	8033116542449

295005 CHIAVI A BUSSOLA BOCCA ESAGONALE FLESSIBILI FLEXIBLE SOCKET WRENCHES, HEXAGONAL MOUTH

- In acciaio al cromo vanadio con finitura satinata
Chrome vanadium steel with satin finish

Codice	Ø mm	mm	gr		Barcode
295005	5	260	111	5	8033183567277
295055	5,5	260	111	5	8033183569578
295006	6	260	111	5	8033183557636
295007	7	270	111	5	8033183557643
295008	8	270	111	5	8033183557216
295010	10	270	111	5	8033183560919



296005 CHIAVI MASCHIO ESAGONALI FLESSIBILI
FLEXIBLE HEXAGONAL MALE WRENCHES



- In acciaio al cromo vanadio con finitura satinata
Chrome vanadium steel with satin finish



Codice	Ø mm	mm	gr		Barcode
296002	2	255	111	5	8033183561176
296025	2,5	255	111	5	8033183560353
296003	3	270	111	5	8033183557650
296035	3,5	255	111	5	80331835561183

Codice	Ø mm	mm	gr		Barcode
296004	4	270	111	5	8033183557667
296045	4,5	255	111	5	8033183560360
296005	5	270	111	5	8033183557674
296006	6	255	111	5	8033183557681

298505 PORTA INSERTO ESAGONALE MAGNETICO FLESSIBILE
FLEXIBLE MAGNETIC HEXAGONAL INSERT HOLDER



- In acciaio al cromo vanadio con finitura satinata
Chrome vanadium steel with satin finish

Codice	mm	gr		Barcode
298505	280	106	5	8033183558206



297001 GIRAVITI "PHILLIPS" FLESSIBILI
FLEXIBLE "PHILLIPS" SCREWDRIVERS



- In acciaio al cromo vanadio con finitura satinata
Chrome vanadium steel with satin finish

Codice	PH	mm	gr		Barcode
297001	PH1	255	111	5	8033183561350
297002	PH2	255	111	5	8033183561367



298010 CHIAVI "TORX" FLESSIBILI
FLEXIBLE "TORX" WRENCHES



- In acciaio al cromo vanadio con finitura satinata
Chrome vanadium steel with satin finish

Codice	TX	mm	gr		Barcode
298010	TX10	255	111	5	8033183569585
298015	TX15	255	111	5	8033183569592
298020	TX20	255	111	5	8033183569608
298025	TX25	255	111	5	8033183569615
298027	TX27	255	111	5	8033183569622



298501 ASTA FLESSIBILE CON MAGNETE TERMINALE
FLEXIBLE ROD WITH TERMINAL MAGNET



- In acciaio al cromo vanadio con finitura satinata
Chrome vanadium steel with satin finish

Codice	mm	gr		Barcode
298501	500	150	5	8033183557308



510001 CHIAVI REGOLABILI A RULLINO ADJUSTABLE ROLLER WRENCHES

- Testa inclinata a 22,5°
Head tilted at 22.5°
- Scala graduata in mm
Graduated scale

Codice	Apertura max / Max opening mm	mm	gr		Barcode
510001	21	150	120	6	8033116541282
510002	26	200	220	6	8033116541299
510003	30	250	350	6	8033116532617
510004	36	300	560	6	8033116541305
510005	45	380	950	3	8033116541312
510006	54	450	1950	2	8033116541329
510007	65	600	3100	2	8033116541336
224651	Espositore / Exhibitor 6 x 510001 - 02; 3 x 510003			1	8033116541343



876001 CHIAVE PER FILTRI OLIO OIL FILTERS KEY

- Nastro metallico
Metallic ribbon
- Vite zigrinata che permette la regolazione
Knurled screw that allows adjustment

Codice	Ø mm	mm	gr		Barcode
876001	da 65 a 110	260	450	2	8033116543088



875012 CHIAVE LEVAGOMME TIRE LEVER WRENCH

- In acciaio al cromo vanadio
Chrome vanadium steel
- Sezione a doppia T per garantire massima resistenza
Double T section to ensure maximum resistance

Codice	mm	gr		Barcode
875012	300	300	2	8033183550552
875013	500	750	2	8033183550569



425001 CHIAVI A CROCE PER DADI RUOTE CROSS WRENCHES FOR WHEEL NUTS

- In acciaio al cromo vanadio con esecuzione cromata
In chrome vanadium steel with chrome finish
- 3 Bocche esagonali da 17, 19, 22 e 1 attacco quadro da 1/2"
3 hexagonal ports 17, 19, 22 and 1 1/2" square drive

Codice	mm		Barcode
425001	360	2	8033116543064
425201	360	2	8033116543071



261301 CHIAVI A 4 USI 4 USE WRENCHES

- In acciaio inox resistente all'uso
In stainless steel resistant to use
- 4 diverse forme tra cui 2 forme quadrate, 1 triangolo e 1 forma di chiave
4 different shapes including 2 square shapes, 1 triangle and 1 key shape
- Con 2 inserti: Viti ad intaglio 1 x 7 mm
Viti con impronta a croce PH2
*With 2 inserts: Slotted screws 1 x 7 mm
Phillips screws PH2*

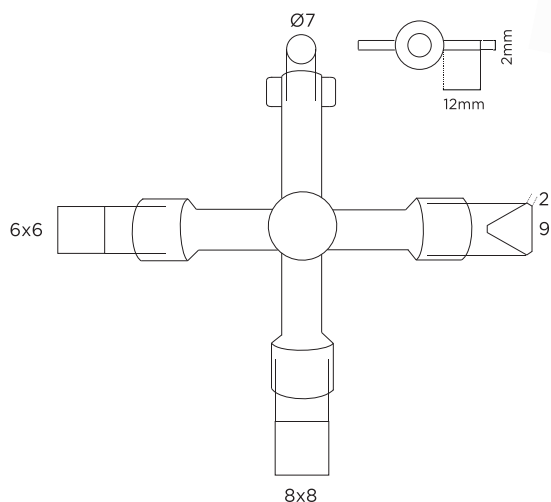

Codice	mm	gr		Barcode
261301	70	50	6	8033183552723

261301P CHIAVE UNIVERSALE PROFESSIONALE PROFESSIONAL UNIVERSAL KEY

- 23 combinazioni
23 combinations

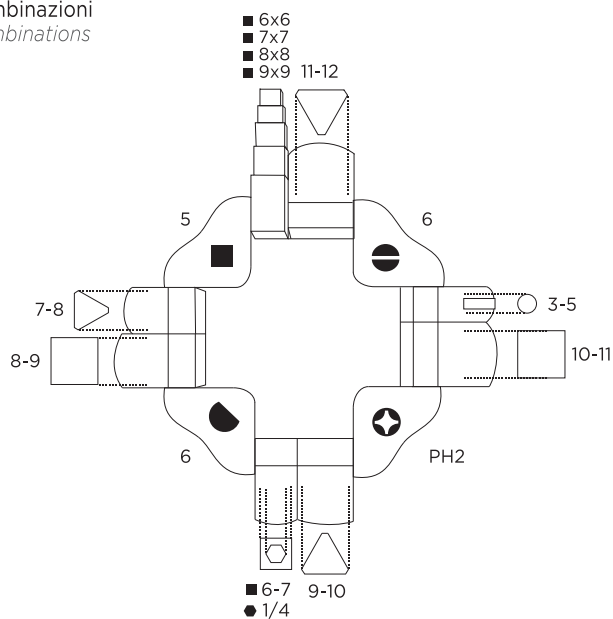

C1

Codice	C1		Barcode
261301P	75	6	8033183838827

876101 ESTRATTORE UNIVERSALE A 2 BRACCI UNIVERSAL 2-ARM PULLER



- In acciaio al cromo vanadio con esecuzione cromata
Chrome vanadium steel
- Bracci reversibili per estrazione esterna ed interna
Reversible arms for external and internal extraction

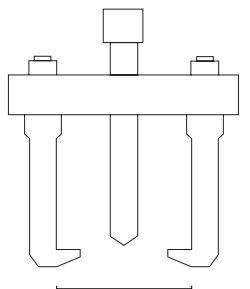

Lunghezza utile vite (B2)
Useful screw length

Lunghezza utile gambe (B1)
Usable leg length

Codice		B1 X B2 mm		Barcode
876101		50 x 75	1	8033116543095
876102		80 x 75	1	8033116543101
876103		120 x 100	1	8033116543118
876104		140 x 100	1	8033116543125
876105		200 x 140	1	8033116543132
876106		250 x 250	1	8033116543149
876100	Espositore 6 pz. / 6 pcs display 876101 - 02 - 03 - 04 - 05 - 06		1	8033183571588
876111	Espositore vuoto / Empty display		1	8033183571595



05

876201 ESTRATTORE UNIVERSALE A 3 BRACCI UNIVERSAL 3-ARM PULLER



- In acciaio al cromo vanadio con esecuzione cromata
Chrome vanadium steel
- 3 bracci per estrazione interna
3 arms for internal extraction

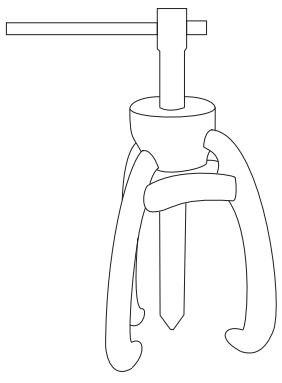

Lunghezza utile vite (B2)
Useful screw length

Lunghezza utile gambe (B1)
Usable leg length

Codice		B1 X B2 mm		Barcode
876201		60 x 50	1	8033183559043
876202		80 x 60	1	8033183559050
876203		120 x 90	1	8033183559135
876204		160 x 110	1	8033183562869
876205		190 x 110	1	8033183571601



Chiavi 1000V

1000V keys

- 1** Impugnatura con isolamento ad immersione a doppio strato per maggiore sicurezza.
Double layer immersion insulated handle for added safety.

039001 CHIAVE REGOLABILE A RULLINO 1000V 1000V ADJUSTABLE ROLLER WRENCH

- Manico con paramano di sicurezza
Handle with safety hand guard

Codice	Apertura max / max opening mm	mm	gr		Barcode
039001	26	200	300	1	8033116537407
039002	20	250	500	1	8033116537414
039003	36	300	800	1	8033116537421



080501 CHIAVE A FORCHETTA SEMPLICE 1000V FORK WRENCH SIMPLE 1000V

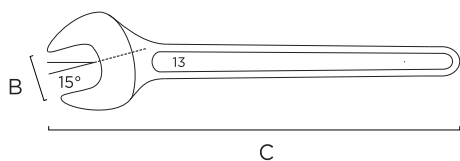

Codice	B mm	C mm	gr		Barcode
080501	6	107	20	1	8033116537513
080502	7	110	20	1	8033116537544
080503	8	113	30	1	8033116537551
080504	9	120	30	1	8033116537568
080505	10	130	40	1	8033116537575
080506	11	135	40	1	8033116537582
080507	12	140	55	1	8033116537599
080508	13	145	55	1	8033116537605



Codice	B mm	C mm	gr		Barcode
080509	14	155	80	1	8033116537612
080510	17	170	110	1	8033116537629
080511	19	180	145	1	8033116537636
080512	22	190	170	1	8033116537643
080513	24	200	275	1	8033116537650
080514	27	215	280	1	8033116537667
080515	30	225	390	1	8033116537674
080516	32	230	400	1	8033116537681

081001 CHIAVE POLIGONALE SEMPLICE 1000V 1000V SIMPLE POLYGONAL KEY

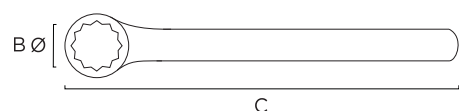

Codice	B mm	C mm	gr		Barcode
081001	6	150	35	1	8033116537698
081002	7	150	35	1	8033116537704
081003	8	160	55	1	8033116537711
081004	9	160	55	1	8033116537728
081005	10	175	85	1	8033116537735
081006	11	175	85	1	8033116537742
081007	12	190	130	1	8033116537759
081008	13	190	130	1	8033116537766



Codice	B mm	C mm	gr		Barcode
081009	14	210	160	1	8033116537773
081010	17	225	205	1	8033116537780
081011	19	230	255	1	8033116537797
081012	22	280	315	1	8033116537803
081013	24	295	430	1	8033116537810
081014	27	295	440	1	8033116537827
081015	30	305	580	1	8033116537834
081016	32	310	600	1	8033116537841



AMPIA SCELTA PER OGNI TIPO DI LAVORO

WIDE CHOICE FOR EVERY KIND OF WORK

06



LINEA PRO
PRO LINE



ISOLATO PER TENSIONE 1000V
INSULATED FOR 1000V VOLTAGE



CONFORME AGLI STANDARD EUROPEI
COMPLIES WITH EUROPEAN STANDARDS



CONFORME ALLE NORME DVE
COMPLIES WITH DVE STANDARDS



PUNTA MAGNETICA
MAGNETIC TIP



IMPRONTA TORX CON FORO
TORX IMPRINT WITH HOLE



IMPRONTA TORX
TORX IMPRINT



IMPRONTA A INTAGLIO
SLOTTED IMPRINT



IMPRONTA A CROCE "PHILLIPS"
"PHILLIPS" IMPRINT



IMPRONTA A CROCE "POZIDRIV"
"POZIDRIV" IMPRINT

134 Accessori da 1/4"
1/4" accessories

140 Accessori da 3/8"
3/8" accessories

143 Accessori da 1/2"
1/2" accessories

148 Accessori da 3/4"
3/4" accessories

152 Accessori da 1"
1" accessories

154 Accessori 1000 VOLT
1000 VOLT accessories

156 Set inserti e bussole
Insert and socket set

UTILIZZI E PROFILI

USES AND PROFILES

L'impiego della chiave a bussola risulta fondamentale per procedere al serraggio o all'allentamento di bulloneria varia.

Esse sono formate due estremità: quella rivolta verso l'operatore presenta l'**innesto quadrato femmina**, il quale accoglie la leva, l'estremità opposta presenta un profilo, avente differenti forme, da introdurre sul bullone in questione per esercitare il tiraggio

The use of the socket wrench is essential for tightening or loosening various nuts and bolts.

They have two ends: the one facing the operator has the square female coupling, which houses the lever, the opposite end has a profile, having different shapes, to be introduced on the bolt in question to exercise the draft

PROFILO / PROFILE		CARATTERISTICHE / FEATURES
POLIGONALE POLIGONALE		Formato da due esagoni con uno sfasamento di 60°, risulta particolarmente comodo per lavorare in spazi molto ristretti e con poco margine di manovra <i>Consisting of two hexagons with a phase shift of 60°, it is particularly comfortable to work in very confined spaces and with little room for maneuver</i>
ESAGONALE ESAGONALE		Consente di lavorare su teste esagonali laddove sia richiesta un'elevata forza di serraggio <i>It allows you to work on hexagonal heads where a high clamping force is required</i>
TORX TORX		Profilo particolare le cui caratteristiche risiedono in un incavo a forma di stella con 6 punte, consente di esercitare una notevole coppia di chiusura <i>Particular profile, whose characteristics reside in a star-shaped recess with 6 points, it allows to exert a considerable closing torque</i>

DIMENSIONI PROFILO QUADRO

SQUARE PROFILE DIMENSIONS

La gamma comprende le classiche chiavi a bussola femmina, bussole maschio con differenti impronte e una offerta completa di accessori con attacchi quadri da 1/4" a 1".

The range includes the classic socket wrenches, male sockets with different recesses and a complete offer of accessories with square connections from 1/4" to 1".



Inch	mm	BULLONI / BOLTS	UTILIZZI / USES
1/4"	6,5	da 4 a 14 mm	Elementi presenti perlopiù nella piccola meccanica di precisione <i>Elements present mostly in small precision mechanics</i>
3/8"	10,0	da 6 a 19 mm	Bulloneria tipica di elettrodomestici, automobili e altri macchinari simili <i>Typical hardware for household appliances, automobiles and other similar machinery</i>
1/2"	12,5	da 13 a 17 mm	Dadi utilizzati laddove si ricorra ad avvitiamenti piuttosto frequenti <i>Nuts used where rather frequent screwing is used</i>
3/4"	20,0	da 15 a 20 mm	Misure meno utilizzate, se non in ambiti industriali e manifatturieri <i>Less used measures, if not in industrial and manufacturing sectors</i>
1"	25,0	da 19 a 50 mm	Tipici nella meccanica pesante, automezzi e macchine agricole <i>Typical in heavy mechanics, vehicles and agricultural machinery</i>

 CRICCHETTI / RATCHETS
BUSSOLE / SOCKET WRENCH
PROLUNGA / EXTENSION KEY
LEVA / LEVER
SNODO / JOINT
IMPUGNATURA PER INSERTI / HANDLE FOR INSERTS
RINVIO ANGOLARE / ANGULAR TRANSMISSION
INSERTI PER AVVITATORI / INSERTS FOR SCREWDRIVERS
SET INSERTI / INSERTS SET

 CRICCHETTI / RATCHETS
BUSSOLE / SOCKET WRENCH
PROLUNGA / EXTENSION KEY
LEVA / LEVER
SNODO / JOINT

 CRICCHETTI / RATCHETS
BUSSOLE / SOCKET WRENCH
PROLUNGA / EXTENSION KEY
LEVA / LEVER
SNODO / JOINT

 CRICCHETTI / RATCHETS
IMPUGNATURA CRICCHETTO / RATCHET HANDLE
BUSSOLE / SOCKET WRENCH
PROLUNGA / EXTENSION KEY
LEVA / LEVER
SNODO / JOINT

 CRICCHETTI / RATCHETS
IMPUGNATURA CRICCHETTO / RATCHET HANDLE
BUSSOLE / SOCKET WRENCH
PROLUNGA / EXTENSION KEY
LEVA / LEVER

Attacco da 1/4"

1/4" drive

345401 CRICCHETTO REVERSIBILE DA 1/4"

REVERSIBLE RATCHET 1/4"

- Corpo in acciaio al cromo vanadio con superficie cromata lucida
Chrome vanadium steel body with polished chrome surface
- Impugnatura in gomma antiscivolo
Non-slip rubber handle
- Pulsante per lo sgancio rapido della bussola
Button for quick release of the compass
- Leva di inversione integrata
Non-slip rubber handle
- Attacco quadro con sfera di fermo
Square drive with stop ball

Codice	mm	mm	gr	📄	Barcode
345401	6,3	195	112	5	8033116543392

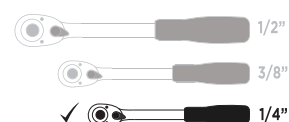

1/4"



345402 CRICCHETTO REVERSIBILE DA 1/4"

REVERSIBLE RATCHET 1/4"

- Corpo in acciaio con trattamento in polipropilene antiruggine
Steel body with anti-rust polypropylene treatment
- Impugnatura in gomma bicolore
Non-slip rubber handle
- Pulsante per lo sgancio rapido della bussola
Button for quick release of the compass
- Leva di inversione integrata
Non-slip rubber handle
- Attacco quadro con sfera di fermo
Square drive with stop ball

Codice	mm	mm	gr	📄	Barcode
345402	6,3	195	112	5	8033116543446

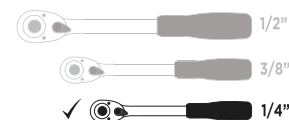

1/4"



345404 CHIAVI A BUSSOLA DA 1/4"
SOCKET WRENCHES 1/4"

- Corpo in acciaio al cromo vanadio con superficie cromata
Chrome vanadium steel body with chrome surface
- Attacchi quadro ed esagonale incassati
Recessed square and hexagonal connections

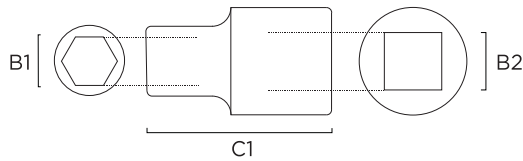

Codice	B1 mm	B2 mm	C1 mm	gr	📦	Barcode
345404	4,0	6,3	25	10	10	8033116543262
3454045	4,5	6,3	25	11	10	8033116543279
345405	5,0	6,3	25	11	10	8033116543286
3454055	5,5	6,3	25	12	10	8033116543293
345406	6,0	6,3	25	12	10	8033116543309
345407	7,0	6,3	25	12	10	8033116543316
345408	8,0	6,3	25	12	10	8033116543323

Codice	B1 mm	B2 mm	C1 mm	gr	📦	Barcode
345409	9,0	6,3	25	14	10	8033116543330
345410	10,0	6,3	25	14	10	8033116543347
345411	11,0	6,3	25	20	10	8033116543354
345412	12,0	6,3	25	22	10	8033116543361
345413	13,0	6,3	25	25	10	8033116543378
345414	14,0	6,3	25	28	10	8033116543385

345504 CHIAVI A BUSSOLA TORX DA 1/4"
TORX SOCKET WRENCHES 1/4"

- Corpo in acciaio al cromo vanadio con superficie cromata
Chrome vanadium steel body with chrome surface
- Attacchi quadro e torx incassati
Embedded square and torx connections

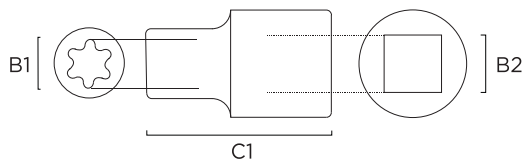

Codice	B1	B2 mm	C1 mm	gr	📦	Barcode
345504	E4	6,3	25	10	10	8033183845467
345505	E5	6,3	25	11	10	8033183845474
345506	E6	6,3	25	12	10	8033183845481

Codice	B1	B2 mm	C1 mm	gr	📦	Barcode
345507	E7	6,3	25	12	10	8033183845498
345508	E8	6,3	25	12	10	8033183845504

345420 PROLUNGA PER CHIAVI A BUSSOLA DA 1/4"
EXTENSION FOR 1/4" SOCKET WRENCHES

- Corpo in acciaio al cromo vanadio con superficie cromata
Chrome vanadium steel body with chrome surface
- Attacco quadro incassato
Built-in square drive

Codice	mm	mm	gr	📦	Barcode
345420	6,3	50	35	5	8033116543408
345421	6,3	100	66	5	8033116543415



345422 LEVA SCORREVOLE DA 1/4"
SLIDING LEVER 1/4"

- Corpo in acciaio al cromo vanadio con superficie cromata lucida
Chrome vanadium steel body with polished chrome surface

Codice	mm	mm	gr	📦	Barcode
345422	6,3	115	42	5	8033116543422



345423 SNODO CARDANICO DA 1/4" 1/4" CARDAN JOINT

- ♦ Corpo in acciaio al cromo vanadio con superficie cromata
Chrome vanadium steel body with chrome surface
- ♦ Attacco quadro incassato
Built-in square drive
- ♦ Attacco quadro di collegamento con sfera di fermo
Square connection connection with stop ball

Codice	mm	mm	gr	📦	Barcode
345423	6,3	40	23	5	8033116543439



1/4"



261001 IMPUGNATURA PER INSERTI DA 1/4" HANDLE FOR 1/4" INSERTS

- ♦ Corpo in acciaio al cromo vanadio
Chrome vanadium steel body
- ♦ Impugnatura anatomica bicomponente con protezione antiscivolo
Bi-component anatomic non-slip grip
- ♦ Attacco esagonale incassato
Hexagonal socket

Codice	mm	mm	gr	📦	Barcode
261001	6,3	210	100	5	8033116531207



1/4"



260701 INSERTI PER AVVITATORI DA 1/4" 1/4" CARDAN JOINT

- ♦ Corpo in acciaio al cromo vanadio con finitura sabbata
Chrome vanadium steel body with sandblasted finish
- ♦ Magnetico
Magnetic

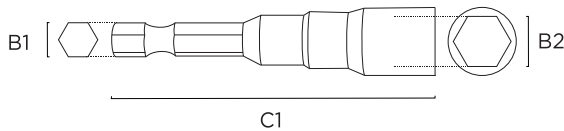

Codice	B2 mm	B1 mm	C1 mm	gr	📦	Barcode
260701	6,0	6,3	65	32	5	8033183559548
260702	6,3	6,3	65	32	5	8033183561305
260703	7,0	6,3	65	32	5	8033183561312
260704	8,0	6,3	65	32	5	8033183559555



1/4"



Codice	B2 mm	B1 mm	C1 mm	gr	📦	Barcode
260705	10,0	6,3	65	36	3	8033183560407
260706	11,0	6,3	65	36	3	8033183561329
260707	12,0	6,3	65	36	3	8033183561336
260708	13,0	6,3	65	40	3	8033183560384

570030 RINVIO ANGOLARE A 90° PROFESSIONALE PROFESSIONAL ANGLE TRANSMISSION 90°

- ♦ Rapido innesto magnetico a mandrino
Quick magnetic spindle coupling
- ♦ Manico smontabile che consente una regolazione a 360°
Removable handle that allows a 360° adjustment
- ♦ Capacità di serraggio 60Nm
Clamping capacity 60Nm
- ♦ Completo di inserto a croce "Phillips" 2 x 25mm
Complete with 2 x 25mm "Phillips" insert

Codice	mm	mm	📦	Barcode
570030	6,3	48 x 83	2	8033183577184



1/4"



260003 SET 10 INSERTI DA 1/4"

1/4" INSERTS SET

Per viti con testa ad intaglio / For slotted screws

- Corpo in acciaio al cromo vanadio con esecuzione sabbiata oliata
Chrome vanadium steel body with sandblasted and oiled execution



Codice	A x B mm	mm	mm	gr		Barcode
260003	0,6 x 4,0	6,3	25	6	10	8033116547321
260005	0,8 x 5,5	6,3	25	8	10	8033116547338
260006	1,0 x 6,5	6,3	25	10	10	8033116547345
260007	1,2 x 8,0	6,3	25	10	10	8033116547352



260003L SET 10 INSERTI LUNGI DA 1/4"

1/4" LONG INSERTS SET

Per viti con testa ad intaglio / For slotted screws

- Corpo in acciaio al cromo vanadio con esecuzione sabbiata oliata
Chrome vanadium steel body with sandblasted and oiled execution



Codice	A x B mm	mm	mm	gr		Barcode
260003L	0,6 x 4,0	6,3	50	6	10	8033183586759
260005L	0,8 x 5,5	6,3	50	8	10	8033183586766
260006L	1,0 x 6,5	6,3	50	10	10	8033183586773
260007L	1,2 x 8,0	6,3	50	10	10	8033183586780



260201 SET 10 INSERTI DA 1/4"

1/4" INSERTS SET

Per viti con impronta a croce "Phillips" / For Phillips screws

- Corpo in acciaio al cromo vanadio con esecuzione sabbiata oliata
Chrome vanadium steel body with sandblasted and oiled execution

Codice	PH	mm	mm	gr		Barcode
260201	PH0	6,3	25	6	10	8033116547369
260202	PH1	6,3	25	6	10	8033116547376
260204	PH2	6,3	25	6	10	8033116547383
260206	PH3	6,3	25	6	10	8033116547390



260201L SET 10 INSERTI LUNGI DA 1/4"

1/4" LONG INSERTS SET

Per viti con impronta a croce "Phillips" / For Phillips screws

- Corpo in acciaio al cromo vanadio con esecuzione sabbiata oliata
Chrome vanadium steel body with sandblasted and oiled execution

Codice	PH	mm	mm	gr		Barcode
260201L	PH0	6,3	50	6	10	8033183586797
260202L	PH1	6,3	50	6	10	8033183586803
260204L	PH2	6,3	50	6	10	8033183586810
260206L	PH3	6,3	50	6	10	8033183586827



260301 SET 10 INSERTI DA 1/4" 1/4" INSERTS SET

Per viti con impronta a croce "Pozidriv" / For Pozidriv screws

- Corpo in acciaio al cromo vanadio con esecuzione sabbiata oliata
Chrome vanadium steel body with sandblasted and oiled execution

Codice	PZ	mm	mm	gr	📦	Barcode
260301	PZ0	6,3	25	6	10	8033116547406
260302	PZ1	6,3	25	6	10	8033116547413
260304	PZ2	6,3	25	6	10	8033116547420
260306	PZ3	6,3	25	6	10	8033116559425



1/4"

260301L SET 10 INSERTI LUNGI DA 1/4" 1/4" LONG INSERTS SET

Per viti con impronta a croce "Pozidriv" / For Pozidriv screws

- Corpo in acciaio al cromo vanadio con esecuzione sabbiata oliata
Chrome vanadium steel body with sandblasted and oiled execution

Codice	PZ	mm	mm	gr	📦	Barcode
260301L	PZ0	6,3	50	6	10	8033183586834
260302L	PZ1	6,3	50	6	10	8033183586841
260304L	PZ2	6,3	50	6	10	8033183586858
260306L	PZ3	6,3	50	6	10	8033183586865



1/4"

260401 SET 10 INSERTI ESAGONALI DA 1/4" 1/4" INSERTS SET

- Corpo in acciaio al cromo vanadio con esecuzione sabbiata oliata
Chrome vanadium steel body with sandblasted and oiled execution

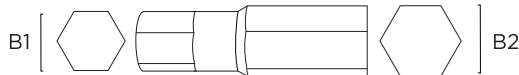

Codice	B1 mm	B2 mm	mm	gr	📦	Barcode
260401	2,5	6,3	25	5	10	8033116547321
260402	3,0	6,3	25	5	10	8033116547338
260404	4,0	6,3	25	5	10	8033116547345
260405	5,0	6,3	25	6	10	8033116547352
260406	6,0	6,3	25	6	10	8033116547345
260408	8,0	6,3	25	8	10	8033116547352



1/4"

260401L SET 10 INSERTI ESAGONALI LUNGI DA 1/4" 1/4" HEXAGONAL LONG INSERTS SET

- Corpo in acciaio al cromo vanadio con esecuzione sabbiata oliata
Chrome vanadium steel body with sandblasted and oiled execution

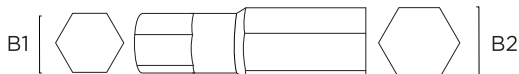

Codice	B1 mm	B2 mm	mm	gr	📦	Barcode
2604015L	2,0	6,3	50	5	10	8033183586681
260401L	2,5	6,3	50	5	10	8033183586698
260402L	3,0	6,3	50	5	10	8033183586704
260404L	4,0	6,3	50	5	10	8033183586711
260405L	5,0	6,3	50	6	10	8033183586728
260406L	6,0	6,3	50	6	10	8033183586735
260408L	8,0	6,3	50	8	10	8033183586742



1/4"

260506 SET 10 INSERTI TORX DA 1/4"

1/4" TORX INSERTS SET

Per viti con impronta "Torx" / For Torx screws

- Corpo in acciaio al cromo vanadio con esecuzione sabbiata oliata
Chrome vanadium steel body with sandblasted and oiled execution

Codice	TX	mm	mm	gr	📦	Barcode
260506	TX6	6,3	25	5	10	8033116547499
260507	TX7	6,3	25	5	10	8033116547505
260508	TX8	6,3	25	5	10	8033116547512
260509	TX9	6,3	25	5	10	8033116547529
260510	TX10	6,3	25	5	10	8033116547536
260515	TX15	6,3	25	5	10	8033116547543
260520	TX20	6,3	25	5	10	8033116547550
260525	TX25	6,3	25	6	10	8033116547567
260527	TX27	6,3	25	6	10	8033116547574
260530	TX30	6,3	25	7	10	8033116547581
260540	TX40	6,3	25	7	10	8033116547598

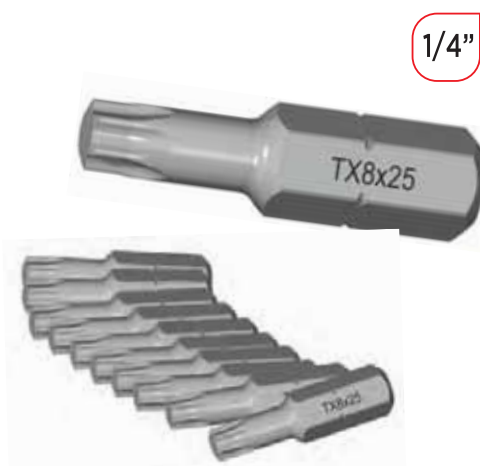

260506L SET 10 INSERTI TORX LUNGI DA 1/4"

1/4" LONG TORX INSERTS SET

Per viti con impronta "Torx" / For Torx screws

- Corpo in acciaio al cromo vanadio con esecuzione sabbiata oliata
Chrome vanadium steel body with sandblasted and oiled execution

Codice	TX	mm	mm	gr	📦	Barcode
260506L	TX6	6,3	50	5	10	8033183586872
260507L	TX7	6,3	50	5	10	8033183586889
260508L	TX8	6,3	50	5	10	8033183586896
260509L	TX9	6,3	50	5	10	8033183586902
260515L	TX15	6,3	50	5	10	8033183586919
260520L	TX20	6,3	50	5	10	8033183586926
260525L	TX25	6,3	50	5	10	8033183586933
260527L	TX27	6,3	50	6	10	8033183590329
260530L	TX30	6,3	50	6	10	8033183586940
260540L	TX40	6,3	50	7	10	8033183586957



260606 SET 10 INSERTI TORX CON FORO DA 1/4"

1/4" TORX WITH HOLE INSERTS SET

Per viti con impronta "Torx" con foro /
For "Torx" head screws with hole

- Corpo in acciaio al cromo vanadio con esecuzione sabbiata oliata
Chrome vanadium steel body with sandblasted and oiled execution

Codice	TX	mm	mm	gr	📦	Barcode
260610	TX10	6,3	25	5	10	8033116547604
260615	TX15	6,3	25	5	10	8033116547611
260620	TX20	6,3	25	5	10	8033116547628
260625	TX25	6,3	25	6	10	8033116547635
260627	TX27	6,3	25	6	10	8033116547642
260630	TX30	6,3	25	7	10	8033116547659
260640	TX40	6,3	25	7	10	8033116547666



260610L SET 10 INSERTI TORX CON FORO LUNGI DA 1/4" 1/4" LONG TORX WITH HOLE INSERTS SET

Per viti con impronta "Torx" con foro /
For "Torx" head screws with hole

- Corpo in acciaio al cromo vanadio con esecuzione sabbata oliata
Chrome vanadium steel body with sandblasted and oiled execution

1/4"



Codice	TX	mm	mm	gr	📦	Barcode
260610L	TX10	6,3	50	5	10	8033183586964
260615L	TX15	6,3	50	5	10	8033183586971
260620L	TX20	6,3	50	5	10	8033183586988
260625L	TX25	6,3	50	6	10	8033183586995
260627L	TX27	6,3	50	6	10	8033183587008
260630L	TX30	6,3	50	7	10	8033183587015
260640L	TX40	6,3	50	7	10	8033183587022

Attacco da 3/8"

3/8" drive

352001 CRICCHETTO REVERSIBILE DA 3/8" REVERSIBLE RATCHET 3/8"

- Corpo in acciaio al cromo vanadio con superficie cromata lucida
Chrome vanadium steel body with polished chrome surface
- Impugnatura in gomma antiscivolo
Non-slip rubber handle
- Pulsante per lo sgancio rapido della bussola
Button for quick release of the compass
- Leva di inversione integrata
Non-slip rubber handle
- Attacco quadro con sfera di fermo
Square drive with stop ball

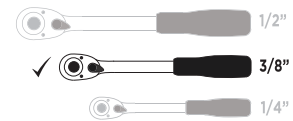

3/8"

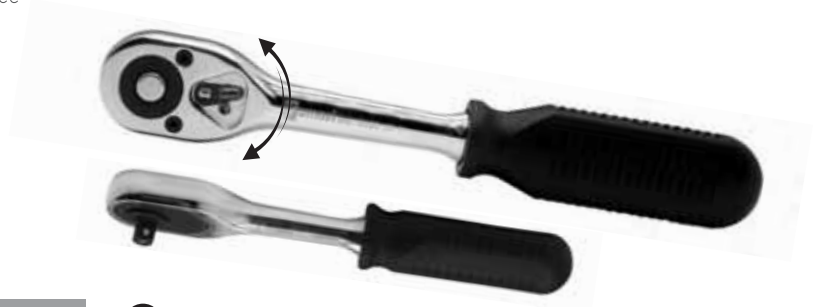

Codice	mm	mm	gr	📦	Barcode
352001	10	215	225	5	8033116543460

352002 CRICCHETTO REVERSIBILE DA 3/8" REVERSIBLE RATCHET 3/8"

- Corpo in acciaio con trattamento in polipropilene antiruggine
Steel body with anti-rust polypropylene treatment
- Impugnatura in gomma bicolore
Non-slip rubber handle
- Pulsante per lo sgancio rapido della bussola
Button for quick release of the compass
- Leva di inversione integrata
Non-slip rubber handle
- Attacco quadro con sfera di fermo
Square drive with stop ball

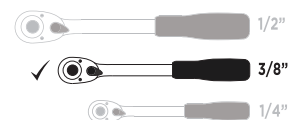

3/8"



Codice	mm	mm	gr	📦	Barcode
352002	10	195	200	5	8033116543477

350006 CHIAVI A BUSSOLA DA 3/8" SOCKET WRENCHES 3/8"

- Corpo in acciaio al cromo vanadio con superficie cromata
Chrome vanadium steel body with chrome surface
- Attacchi quadro e poligonale incassati
Recessed square and polygonal connections

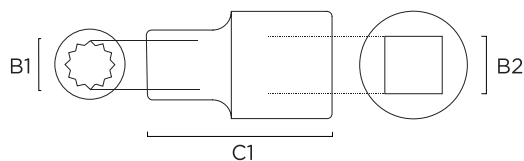

Codice	B1 mm	B2 mm	C1 mm	gr		Barcode
350006	6,0	10	28	20	10	8033116543484
350007	7,0	10	28	21	10	8033116543491
350008	8,0	10	28	22	10	8033116543507
350009	9,0	10	28	23	10	8033116543514
350010	10,0	10	28	23,5	10	8033116543521
350011	11,0	10	28	24	10	8033116543538
350012	12,0	10	28	25	10	8033116543545
350013	13,0	10	28	29	10	8033116531603
350014	14,0	10	28	33	10	8033116543552

Codice	B1 mm	B2 mm	C1 mm	gr		Barcode
350015	15,0	10	28	44	10	8033116543569
350016	16,0	10	28	45	10	8033116543576
350017	17,0	10	30	50	10	8033116543583
350018	18,0	10	30	55	10	8033116543590
350019	19,0	10	30	58	10	8033116543606
350020	20,0	10	32	59	10	8033116543613
350021	21,0	10	32	63	10	8033116543620
350022	22,0	10	32	79	10	8033116543637



345510 CHIAVI A BUSSOLA TORX DA 3/8" TORX SOCKET WRENCHES 3/8"

- Corpo in acciaio al cromo vanadio con superficie cromata
Chrome vanadium steel body with chrome surface
- Attacchi quadro e torx incassati
Embedded square and torx connections

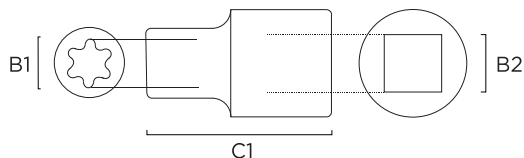

Codice	B1	B2 mm	C1 mm	gr		Barcode
345510	E10	10	28	23,5	10	8033183845511
345511	E11	10	28	24	10	8033183845528
345512	E12	10	28	25	10	8033183845535
345514	E14	10	28	33	10	8033183845542
345516	E16	10	28	45	10	8033183845559



345425 BUSSOLA DI MAGGIORAZIONE DA 3/8" A 1/2" INCREASE SLEEVE FROM 3/8" TO 1/2"

- Corpo in acciaio al cromo vanadio con superficie cromata
Chrome vanadium steel body with chrome surface
- Attacco quadro incassato
Built-in square drive
- Attacco quadro di collegamento con sfera di fermo
Square connection connection with stop ball

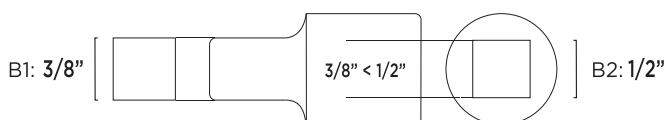

Codice	B1 mm	B2 mm	mm	gr		Barcode
345425	10	12,5	28	48	5	8033183557254



345425R BUSSOLA DI RIDUZIONE DA 3/8" A 1/4" REDUCING SLEEVE FROM 3/8" TO 1/4"

3/8"

- Corpo in acciaio al cromo vanadio con superficie cromata
Chrome vanadium steel body with chrome surface
- Attacco quadro incassato
Built-in square drive
- Attacco quadro di collegamento con sfera di fermo
Square connection connection with stop ball

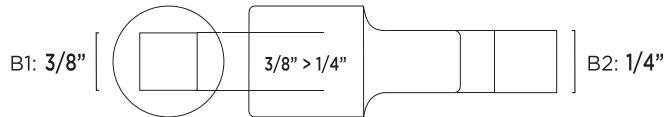

Codice	B1 mm	B2 mm	mm	gr	📄	Barcode
345425R	10	6,3	XX	33	5	8033183557629



06

352601 PROLUNGA PER CHIAVI A BUSSOLA DA 3/8" EXTENSION FOR 3/8" SOCKET WRENCHES

3/8"

- Corpo in acciaio al cromo vanadio con superficie cromata lucida
Chrome vanadium steel body with polished chrome surface
- Attacco quadro incassato
Built-in square drive
- Attacco quadro di collegamento con sfera di fermo
Square connection connection with stop ball

Codice	mm	mm	gr	📄	Barcode
352601	10	125	120	5	8033116543668
352801	10	250	220	5	8033116531597



352401 LEVA SCORREVOLE DA 3/8" SLIDING LEVER 3/8"

3/8"

- Corpo in acciaio al cromo vanadio con superficie cromata lucida
Chrome vanadium steel body with polished chrome surface
- Asta di manovra scorrevole
Sliding operating rod

Codice	mm	mm	gr	📄	Barcode
352401	10	165	160	5	8033116543651

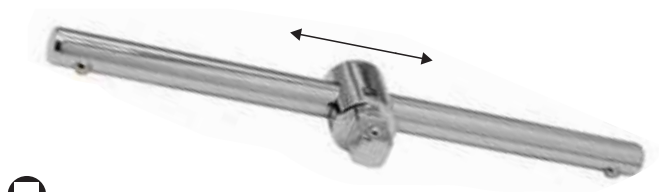

353001 SNODO CARDANICO DA 3/8" 3/8" CARDAN JOINT

3/8"

- Corpo in acciaio al cromo vanadio con superficie cromata
Chrome vanadium steel body with chrome surface
- Attacco quadro incassato
Built-in square drive
- Attacco quadro di collegamento con sfera di fermo
Square connection connection with stop ball

Codice	mm	mm	gr	📄	Barcode
353001	10	56	70	5	8033116543675



Attacco da 1/2"

1/2" drive

362005 CRICCHETTO REVERSIBILE DA 1/2" REVERSIBLE RATCHET 1/2"

- Corpo in acciaio al cromo vanadio con superficie cromata lucida
Chrome vanadium steel body with polished chrome surface
- Impugnatura in gomma antiscivolo
Non-slip rubber handle
- Pulsante per lo sgancio rapido della bussola
Button for quick release of the compass
- Leva di inversione integrata
Non-slip rubber handle
- Attacco quadro con sfera di fermo
Square drive with stop ball

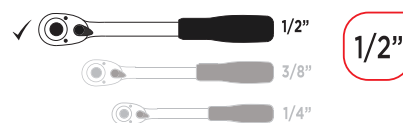

Codice	mm	mm	gr	📦	Barcode
362005	12,5	260	500	5	8033116532075



362006 CRICCHETTO REVERSIBILE DA 1/2" REVERSIBLE RATCHET 1/2"

- Corpo in acciaio con trattamento in polipropilene antiruggine
Steel body with anti-rust polypropylene treatment
- Impugnatura in gomma bicolore
Non-slip rubber handle
- Pulsante per lo sgancio rapido della bussola
Button for quick release of the compass
- Leva di inversione integrata
Non-slip rubber handle
- Attacco quadro con sfera di fermo
Square drive with stop ball



Codice	mm	mm	gr	📦	Barcode
362006	12,5	260	400	5	8033116543941



360013LE CHIAVI A BUSSOLA LUNGHE DA 1/2" 1/2" LONG SOCKET WRENCHES

- Corpo in acciaio al cromo vanadio con superficie cromata
Chrome vanadium steel body with chrome surface
- Attacchi quadro ed esagonale incassati
Recessed square and hexagonal connections

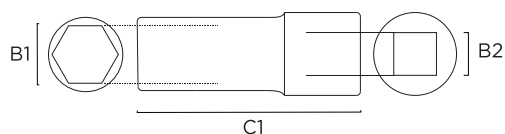

1/2"



Codice	B1 mm	B2 mm	C1 mm	gr	📦	Barcode
360013LE	13,0	12,5	77	76	5	8033183569646
360017LE	17,0	12,5	77	76	5	8033183569653
360019LE	19,0	12,5	77	76	5	8033183569660
360022LE	22,0	12,5	77	76	5	8033183569684

Codice	B1 mm	B2 mm	C1 mm	gr	📦	Barcode
360024LE	24,0	12,5	77	76	5	8033183569707
360027LE	27,0	12,5	77	76	5	8033183569721
360030LE	30,0	12,5	77	76	5	8033183569745
360032LE	32,0	12,5	77	76	5	8033183569769

363010L CHIAVI A BUSSOLA LUNGHE FOSFATATE DA 1/2"
LONG SOCKET WRENCHES 1/2" PHOSPHATED

- ♦ Corpo in acciaio al cromo vanadio con superficie fosfatata
Chrome vanadium steel body with phosphated surface
- ♦ Attacchi quadro ed esagonale incassati
Recessed square and hexagonal connections

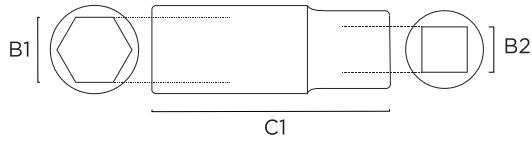

Codice	B1 mm	B2 mm	C1 mm	gr		Barcode
363010L	10,0	12,5	77	78	5	8033183557285
363011L	11,0	12,5	77	78	5	8033183558718
363012L	12,0	12,5	77	78	5	8033183557292
363013L	13,0	12,5	77	78	5	8033183557278
363014L	14,0	12,5	77	78	5	8033183558725
363015L	15,0	12,5	77	78	5	8033183558732
363016L	16,0	12,5	77	78	5	8033183558749
363017L	17,0	12,5	77	78	5	8033183557964
363018L	18,0	12,5	77	78	5	8033183558756



Codice	B1 mm	B2 mm	C1 mm	gr		Barcode
363019L	19,0	12,5	77	78	5	8033183557957
363021L	21,0	12,5	77	78	5	8033183558763
363022L	22,0	12,5	77	78	5	8033183558770
363024L	24,0	12,5	77	78	2	8033183558244
363026L	26,0	12,5	77	78	2	8033183559868
363027L	27,0	12,5	77	78	2	8033183558794
363028L	28,0	12,5	77	78	2	8033183558800
363030L	30,0	12,5	77	78	2	8033183558817
363032L	32,0	12,5	77	78	2	8033183558824

360008E CHIAVI A BUSSOLA DA 1/2"
SOCKET WRENCHES 1/2"

- ♦ Corpo in acciaio al cromo vanadio con superficie cromata
Chrome vanadium steel body with chrome surface
- ♦ Attacchi quadro ed esagonale incassati
Recessed square and hexagonal connections

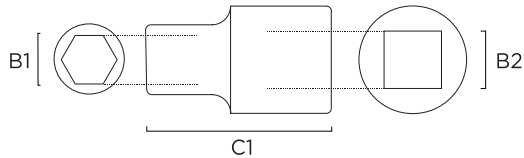

Codice	B1 mm	B2 mm	C1 mm	gr		Barcode
360008E	8,0	12,5	37	35	10	8033183560483
360009E	9,0	12,5	37	40	10	8033183560490
360010E	10,0	12,5	37	50	10	8033183555625
360011E	11,0	12,5	37	55	10	8033183555632
360012E	12,0	12,5	37	60	10	8033183555649
360013E	13,0	12,5	37	62	10	8033183555656
360014E	14,0	12,5	37	65	10	8033183555663
360015E	15,0	12,5	37	68	10	8033183555670
360016E	16,0	12,5	37	70	10	8033183555687
360017E	17,0	12,5	37	73	10	8033183555694
360018E	18,0	12,5	37	77	10	8033183555700
360019E	19,0	12,5	37	80	10	8033183555717



Codice	B1 mm	B2 mm	C1 mm	gr		Barcode
360020E	20,0	12,5	37	85	10	8033183555724
360021E	21,0	12,5	37	90	10	8033183555731
360022E	22,0	12,5	37	100	10	8033183555748
360023E	23,0	12,5	37	105	10	8033183555755
360024E	24,0	12,5	37	110	10	8033183555762
360025E	25,0	12,5	37	120	10	8033183555779
360026E	26,0	12,5	37	125	10	8033183555786
360027E	27,0	12,5	43	130	10	8033183555793
360028E	28,0	12,5	43	140	10	8033183555809
360030E	30,0	12,5	43	165	10	8033183555816
360032E	32,0	12,5	43	195	10	8033183555823

363010 CHIAVI A BUSSOLA FOSFATATE DA 1/2" 1/2" SOCKET WRENCHES PHOSPHATE FINISH

- Corpo in acciaio al cromo vanadio con superficie fosfatata
Chrome vanadium steel body with phosphated surface
- Attacchi quadro ed esagonale incassati
Recessed square and hexagonal connections

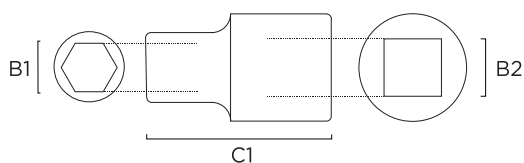

Codice	B1 mm	B2 mm	C1 mm	gr		Barcode
363010	10,0	12,5	37	38	5	8033183558350
363011	11,0	12,5	37	38	5	8033183569776
363012	12,0	12,5	37	38	5	8033183569783
363013	13,0	12,5	37	38	5	8033183559739
363014	14,0	12,5	37	38	5	8033183569790
363015	15,0	12,5	37	38	5	8033183569806
363016	16,0	12,5	37	38	5	8033183569813
363017	17,0	12,5	37	38	5	8033183561787
363018	18,0	12,5	37	38	5	8033183561794
363019	19,0	12,5	37	38	5	8033183561800



1/2"



Codice	B1 mm	B2 mm	C1 mm	gr		Barcode
363020	20,0	12,5	37	38	5	8033183569820
363021	21,0	12,5	37	38	5	8033183569837
363022	22,0	12,5	37	38	5	8033183557360
363023	23,0	12,5	37	38	2	8033183569844
363024	24,0	12,5	37	38	2	8033183557377
363026	26,0	12,5	37	50	2	8033183569851
363027	27,0	12,5	43	50	2	8033183557384
363030	30,0	12,5	43	50	2	8033183557391
363032	32,0	12,5	43	50	2	8033183557407

345518 CHIAVI A BUSSOLA TORX DA 1/2" TORX SOCKET WRENCHES 1/2

- Corpo in acciaio al cromo vanadio con superficie cromata
Chrome vanadium steel body with chrome surface
- Attacchi quadro e torx incassati
Embedded square and torx connections

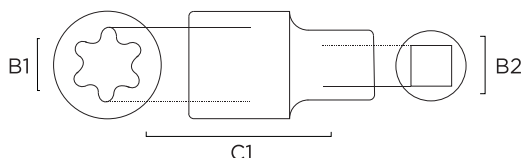

Codice	B1	B2 mm	C1 mm	gr		Barcode
345518	E18	12,5	28	23,5	10	8033183845566
345520	E20	12,5	28	24	10	8033183845573



1/2"



Codice	B1	B2 mm	C1 mm	gr		Barcode
345522	E22	12,5	28	25	10	8033183845580
345524	E24	12,5	28	33	10	8033183845597

360013L CHIAVI A BUSSOLA LUNGHE DA 1/2" 1/2" LONG SOCKET WRENCHES

- Corpo in acciaio al cromo vanadio con superficie cromata
Chrome vanadium steel body with chrome surface

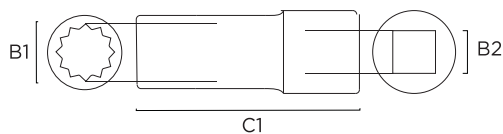

Codice	B1 mm	B2 mm	C1 mm	gr		Barcode
360013L	13,0	12,5	77	76	5	8033183569639
360017L	17,0	12,5	77	76	5	8033183557872
360019L	19,0	12,5	77	76	5	8033183557889
360022L	22,0	12,5	77	76	5	8033183569677



1/2"



Codice	B1 mm	B2 mm	C1 mm	gr		Barcode
360024L	24,0	12,5	77	76	5	8033183569691
360027L	27,0	12,5	77	76	5	8033183569714
360030L	30,0	12,5	77	76	5	8033183569738
360032L	32,0	12,5	77	76	5	8033183569752

360008 CHIAVI A BUSSOLA DA 1/2" SOCKET WRENCHES 1/2"

- ♦ Corpo in acciaio al cromo vanadio con superficie cromata
Chrome vanadium steel body with chrome surface
- ♦ Attacchi quadro e poligonale incassati
Recessed square and polygonal connections

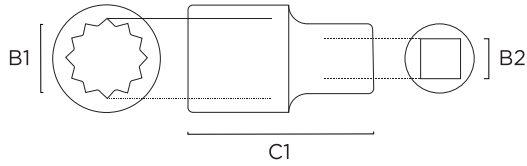

1/2"



Codice	B1 mm	B2 mm	C1 mm	gr	📦	Barcode
360008	8,0	12,5	37	35	10	8033116543712
360009	9,0	12,5	37	40	10	8033116543729
360010	10,0	12,5	37	50	10	8033116543736
360011	11,0	12,5	37	55	10	8033116543743
360012	12,0	12,5	37	60	10	8033116543750
360013	13,0	12,5	37	62	10	8033116543767
360014	14,0	12,5	37	65	10	8033116543774
360015	15,0	12,5	37	68	10	8033116543781
360016	16,0	12,5	37	70	10	8033116543798
360017	17,0	12,5	37	73	10	8033116543804
360018	18,0	12,5	37	77	10	8033116543811
360019	19,0	12,5	37	80	10	8033116532044

Codice	B1 mm	B2 mm	C1 mm	gr	📦	Barcode
360020	20,0	12,5	37	85	10	8033116543828
360021	21,0	12,5	37	90	10	8033116543835
360022	22,0	12,5	37	100	10	8033116532051
360023	23,0	12,5	37	105	10	8033116543842
360024	24,0	12,5	37	110	10	8033116543859
360025	25,0	12,5	37	120	10	8033116543866
360026	26,0	12,5	37	125	10	8033116543873
360027	27,0	12,5	43	130	10	8033116532068
360028	28,0	12,5	43	140	10	8033116543880
360030	30,0	12,5	43	165	10	8033116543897
360032	32,0	12,5	43	195	10	8033116543903

364510 BUSSOLE A GIRAVITE DA 1/2" 1/2" SCREWDRIVER SOCKETS

- ♦ Corpo in acciaio al cromo vanadio con superficie cromata
Chrome vanadium steel body with chrome surface
- ♦ Con inserto ad intaglio inserito a pressione
With press-fit notch insert
- ♦ Attacco quadro incassato
Built-in square drive



1/2"



Codice	A x B mm	mm	mm	gr	📦	Barcode
364510	1,2 x 8,0	12,5	55	77	5	8033116544139
364511	1,6 x 9,0	12,5	55	80	5	8033116544146
364515	2,0 x 12,0	12,5	55	90	5	8033116544153

364602 BUSSOLE A GIRAVITE DA 1/2" 1/2" SCREWDRIVER SOCKETS

- ♦ Corpo in acciaio al cromo vanadio con superficie cromata
Chrome vanadium steel body with chrome surface
- ♦ Con inserto a croce "Phillips" inserito a pressione
With push-fit "Phillips" insert
- ♦ Attacco quadro incassato
Built-in square drive



1/2"



Codice	PH	mm	mm	gr	📦	Barcode
364602	PH2	12,5	55	70	5	8033116544160
364603	PH3	12,5	55	70	5	8033116544177
364604	PH4	12,5	55	80	5	8033116544184

364004 BUSSOLE A GIRAVITE DA 1/2" 1/2" SCREWDRIVER SOCKETS

- ♦ Corpo in acciaio al cromo vanadio con superficie cromata
Chrome vanadium steel body with chrome surface
- ♦ Con inserto esagonale inserito a pressione
With push-fit hexagonal insert
- ♦ Attacco quadro incassato
Built-in square drive

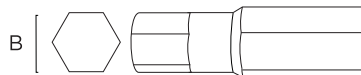

Codice	B1 mm	mm	mm	gr		Barcode
364004	4,0	12,5	55	55	5	8033116543996
364005	5,0	12,5	55	55	5	8033116544009
364006	6,0	12,5	55	55	5	8033116544023
364007	7,0	12,5	55	70	5	8033116544030
364008	8,0	12,5	55	73	5	8033116544054
364010	10,0	12,5	55	88	5	8033116544078
364012	12,0	12,5	55	100	5	8033116544092
364014	14,0	12,5	55	111	5	8033116544108
364017	17,0	12,5	55	163	5	8033116544115
364019	19,0	12,5	55	182	5	8033116544122



1/2"



364005L BUSSOLE LUNGHE A GIRAVITE DA 1/2" 1/2" LONG SCREWDRIVER SOCKETS

- ♦ Corpo in acciaio al cromo vanadio con superficie cromata
Chrome vanadium steel body with chrome surface
- ♦ Con inserto esagonale lungo inserito a pressione
With long press-fit hexagonal insert
- ♦ Attacco quadro incassato
Built-in square drive



Codice	B1 mm	mm	mm	gr		Barcode
364005L	5,0	12,5	100	65	5	8033116544016
364006L	6,0	12,5	100	74	5	8033116544062
364007L	7,0	12,5	100	80	5	8033116544047
364008L	8,0	12,5	100	92	5	8033116544061
364010L	10,0	12,5	100	110	5	8033116544085



1/2"



362601 PROLUNGA PER CHIAVI A BUSSOLA DA 1/2" EXTENSION FOR 1/2" SOCKET WRENCHES

- ♦ Corpo in acciaio al cromo vanadio con superficie cromata lucida
Chrome vanadium steel body with polished chrome surface
- ♦ Attacco quadro incassato
Built-in square drive
- ♦ Attacco quadro di collegamento con sfera di fermo
Square connection connection with stop ball

Codice	mm	mm	gr		Barcode
362601	12,5	125	170	5	8033116531580
362801	12,5	250	315	5	8033116543910



1/2"



362401 LEVA SCORREVOLE DA 1/2" SLIDING LEVER 1/2"

1/2"

- Corpo in acciaio al cromo vanadio con superficie cromata lucida
Chrome vanadium steel body with polished chrome surface
- Asta di manovra scorrevole
Sliding operating rod

Codice	mm	mm	gr	📦	Barcode
362401	12,5	250	375	5	8033116543927



363001 SNODO CARDANICO DA 1/2" 1/2" CARDAN JOINT

1/2"

- Corpo in acciaio al cromo vanadio con superficie cromata
Chrome vanadium steel body with chrome surface
- Attacco quadro incassato
Built-in square drive
- Attacco quadro di collegamento con sfera di fermo
Square connection connection with stop ball

Codice	mm	mm	gr	📦	Barcode
363001	12,5	75	315	5	8033116543934



Attacco da 3/4" 3/4" drive

378101 TESTA A CRICCHETTO DA 3/4" (NO IMPUGNATURA) 3/4" RATCHET HEAD (NO HANDLE)

3/4"

- Corpo in acciaio al cromo vanadio con finitura brunita
Chrome vanadium steel body with burnished finish
- Pulsante per lo sgancio rapido della bussola
Button for quick release of the compass
- Leva di inversione integrata
Non-slip rubber handle
- Attacco quadro con sfera di fermo
Square drive with stop ball



*Si intende solo la testa, adattabile all'impugnatura art. 378201
Intended for single head suitable for handle art. 378201

Codice	mm	mm	gr	📦	Barcode	
378101	Solo testa /Head only	20	145	1000	1	8033116547130

378201 IMPUGNATURA PER CRICCHETTO DA 3/4" (NO TESTA)
HANDLE FOR 3/4" RATCHET (NO HEAD)

3/4"

- Corpo in acciaio al cromo vanadio con superficie cromata
Chrome vanadium steel body with chrome surface

*Si intende impugnatura singola, adattabile a testa art. 378101
Intended for single handle suitable for head art.378101

Codice		mm	mm	gr		Barcode
378201	Solo manico /Handle only	20	450	1000	1	8033116547147

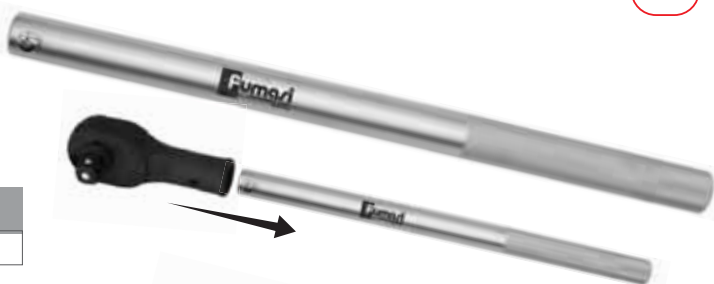

375022 CHIAVI A BUSSOLA DA 3/4"
SOCKET WRENCHES 3/4"

3/4"

- Corpo in acciaio al cromo vanadio con superficie cromata
Chrome vanadium steel body with chrome surface
- Attacchi quadro e poligonale incassati
Recessed square and polygonal connections

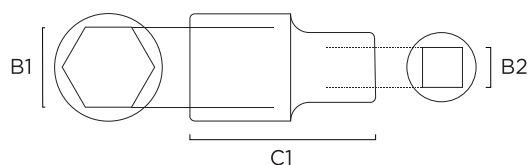

Codice	B1 mm	B2 mm	C1 mm	gr		Barcode
375022	22	20	52	200	4	8033116544191
375023	23	20	52	210	4	8033116544207
375024	24	20	52	225	4	8033116544214
375026	26	20	53	275	4	8033116544221
375027	27	20	53	280	4	8033116544238
375028	28	20	53	285	4	8033116544245
375030	30	20	55	300	4	8033116544252

Codice	B1 mm	B2 mm	C1 mm	gr		Barcode
375032	32	20	58	320	4	8033116544269
375033	33	20	58	330	4	8033116544276
375036	36	20	62	450	2	8033116532396
375038	38	20	65	490	2	8033116544290
375041	41	20	68	525	2	8033116544306
375046	46	20	73	740	2	8033116544313
375050	50	20	76	835	2	8033116544320

373019 CHIAVI A BUSSOLA FOSFATATE DA 3/4"
3/4" SOCKET WRENCHES PHOSPHATE FINISH

3/4"

- Corpo in acciaio al cromo vanadio con superficie fosfatata
Chrome vanadium steel body with phosphated surface
- Attacchi quadro ed esagonale incassati
Recessed square and hexagonal connections

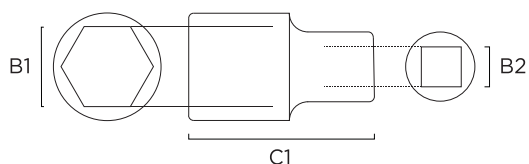

Codice	B1 mm	B2 mm	C1 mm		Barcode
373019	19	20	51	2	8033183569899
373021	21	20	51	2	8033183569912
373022	22	20	51	2	8033183563996
373023	23	20	51	2	8033183569943
373024	24	20	51	2	8033183569950
373026	26	20	53	2	8033183569967
373027	27	20	53	2	8033183561596
373028	28	20	53	2	8033183569974
373030	30	20	53	2	8033183569998

Codice	B1 mm	B2 mm	C1 mm		Barcode
373032	32	20	57	2	8033183564009
373033	33	20	57	2	8033183561602
373034	34	20	57	2	8033183570017
373036	36	20	57	2	8033183557315
373038	38	20	57	2	8033183557322
373041	41	20	58	1	8033183557339
373046	46	20	62	1	8033183557346
373050	50	20	68	1	8033183557353

373019L CHIAVI A BUSSOLA LUNGHE FOSFATATE DA 3/4"
LONG SOCKET WRENCHES 3/4" PHOSPHATED

- ♦ Corpo in acciaio al cromo vanadio con superficie fosfatata
Chrome vanadium steel body with phosphated surface
- ♦ Attacchi quadro ed esagonale incassati
Recessed square and hexagonal connections

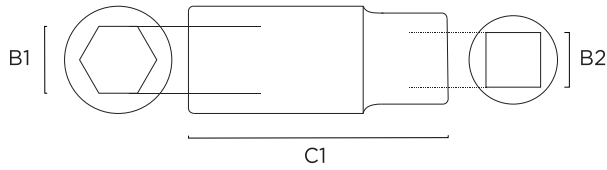

Codice	B1 mm	B2 mm	C1 mm		Barcode
373019L	19	20	51	2	8033183569905
373021L	21	20	51	2	8033183569929
373022L	22	20	51	2	8033183569936
373024L	24	20	51	2	8033183561619
373027L	27	20	53	2	8033183561626
373029L	29	20	53	2	8033183569981
373030L	30	20	53	2	8033183564672
373032L	32	20	57	2	8033183561633



Codice	B1 mm	B2 mm	C1 mm		Barcode
373033L	33	20	57	2	8033183570000
373035L	35	20	57	2	8033183570024
373036L	36	20	57	2	8033183570031
373038L	38	20	57	2	8033183570048
373040L	40	20	58	1	8033183570055
373041L	41	20	58	1	8033183570062
373046L	46	20	62	1	8033183570079

376001 BUSSOLA DI MAGGIORAZIONE DA 3/4" A 1"
INCREASE SLEEVE FROM 3/4" TO 1"

- ♦ Corpo in acciaio al cromo vanadio con superficie cromata
Chrome vanadium steel body with chrome surface
- ♦ Attacco quadro incassato
Built-in square drive
- ♦ Attacco quadro di collegamento con sfera di fermo
Square connection connection with stop ball

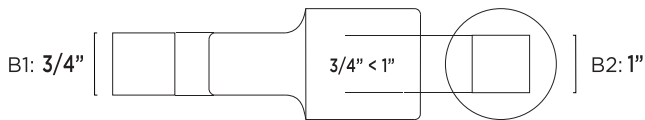

Codice	B1 mm	B2 mm	mm	gr		Barcode
376001	20	25	60	340	2	8033116544344



375501 BUSSOLA DI RIDUZIONE DA 3/4" A 1/2"
REDUCING SLEEVE FROM 3/4" TO 1/2"

- ♦ Corpo in acciaio al cromo vanadio con superficie cromata
Chrome vanadium steel body with chrome surface
- ♦ Attacco quadro incassato
Built-in square drive
- ♦ Attacco quadro di collegamento con sfera di fermo
Square connection connection with stop ball

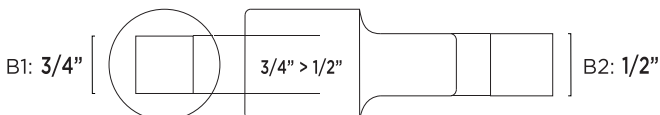

Codice	B1 mm	B2 mm	mm	gr		Barcode
375501	20	12,5	56	175	2	8033116544337



376501 PROLUNGA PER CHIAVI A BUSSOLA DA 3/4"
EXTENSION FOR 3/4" SOCKET WRENCHES

3/4"

- Corpo in acciaio al cromo vanadio con superficie cromata lucida
Chrome vanadium steel body with polished chrome surface
- Attacco quadro incassato
Built-in square drive
- Attacco quadro di collegamento con sfera di fermo
Square connection connection with stop ball

Codice	mm	mm	gr	📦	Barcode
376501	20	200	650	2	8033116547079
376502	20	400	1200	2	8033116547086



377501 LEVA SCORREVOLE DA 3/4"
SLIDING LEVER 3/4"

3/4"

- Corpo in acciaio al cromo vanadio con superficie cromata lucida
Chrome vanadium steel body with polished chrome surface
- Asta di manovra scorrevole
Sliding operating rod

Codice	mm	mm	gr	📦	Barcode
377501	20	495	1350	2	8033116547109



377001 LEVA SNODATA DA 3/4"
3/4" ARTICULATED LEVER

3/4"

- Corpo in acciaio al cromo vanadio con superficie cromata
Chrome vanadium steel body with chrome surface
- Testa a snodo girevole
Sliding operating rod

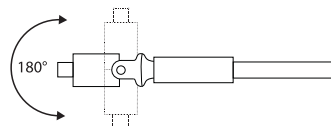

Codice	mm	mm	gr	📦	Barcode
377001	20	495	1600	1	8033116547093



377701 LEVA AD ANGOLO DA 3/4"
3/4" ANGLE LEVER

3/4"

- Corpo in acciaio al cromo vanadio con superficie cromata
Chrome vanadium steel body with chrome surface

Codice	mm	mm	gr	📦	Barcode
377701	20	305	820	1	8033116547123



377601 SNODO CARDANICO DA 3/4"
2/4" CARDAN JOINT

3/4"

- Corpo in acciaio al cromo vanadio con superficie cromata
Chrome vanadium steel body with chrome surface
- Attacco quadro incassato
Built-in square drive
- Attacco quadro di collegamento con sfera di fermo
Square connection with stop ball



Codice	mm	mm	gr	📦	Barcode
377601	20	102	430	1	8033116547116

Attacco da 1"

1" drive

388001 TESTA A CRICCHETTO REVERSIBILE DA 1" (NO IMPUGNATURA) 1" REVERSIBLE RATCHET HEAD (NO HANDLE)

1"

- Testa a cricchetto
Ratchet head
- Corpo in acciaio al cromo vanadio con finitura cromata
Chrome vanadium steel body with chrome finish
- Funzionamento in senso orario e antiorario senza rimuovere la testa dalle viti a un'unica direzione
Clockwise and counterclockwise operation without removing the head from the screws to a single direction
- Attacco quadro con sfera di fermo
Square drive with stop ball



*Si intende solo la testa, adattabile all'impugnatura art. 388101
Intended for single head suitable for handle art. 388101

Codice		mm	mm	gr	📦	Barcode
388001	Solo testa /Head only	25	190	1925	1	8033116547291



388101 IMPUGNATURA PER CRICCHETTO DA 1" (NO TESTA) HANDLE FOR 1" RATCHET (NO HEAD)

1"

- Corpo in acciaio al cromo vanadio con superficie cromata
Chrome vanadium steel body with chrome surface

*Si intende impugnatura singola, adattabile a testa art. 388001
Intended for single handle suitable for head art. 388001



Codice		mm	mm	gr	📦	Barcode
388101	Solo manico /Handle only	25	508	1950	1	8033116547307

385041 CHIAVI A BUSSOLA DA 1" 1" SOCKET WRENCHES

1"

- Corpo in acciaio al cromo vanadio con superficie cromata
Chrome vanadium steel body with chrome surface
- Attacchi quadro ed esagonale incassati
Recessed square and hexagonal connections

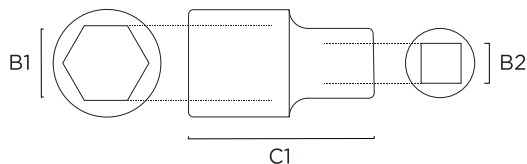

Codice	B1 mm	B2 mm	C1 mm	gr	📦	Barcode
385041	41,0	25	67	620	1	8033116547161
385046	46,0	25	71	750	1	8033116547178
385050	50,0	25	74	900	1	8033116547185
385055	55,0	25	79	1200	1	8033116547192
385060	60,0	25	83	1400	1	8033116547208
385065	65,0	25	86	1650	1	8033116547215
385070	70,0	25	91	2000	1	8033116547222
385075	75,0	25	95	2300	1	8033116547239
385080	80,0	25	101	2800	1	8033116547246

383036 CHIAVI A BUSSOLA FOSFATATE DA 1" 1" PHOSPHATED SOCKET WRENCHES

- Corpo in acciaio al cromo vanadio con superficie fosfatata
Chrome vanadium steel body with phosphated surface
- Attacchi quadro ed esagonale incassati
Recessed square and hexagonal connections



1"



Codice	B1 mm	B2 mm	C1 mm	Icona	Barcode
383036	36,0	25	66	1	8033183570147
383038	38,0	25	66	1	8033183570154
383041	41,0	25	66	1	8033183570161
383046	46,0	25	72	1	8033183570178
383050	50,0	25	76	1	8033183570185
383055	55,0	25	84	1	8033183570192

Codice	B1 mm	B2 mm	C1 mm	Icona	Barcode
383060	60,0	25	86	1	8033183570208
383065	65,0	25	92	1	8033183570215
383070	70,0	25	96	1	8033183570222
383075	75,0	25	102	1	8033183570239
383080	80,0	25	102	1	8033183562593

385501 BUSSOLA DI RIDUZIONE DA 1" A 3/4" REDUCING SLEEVE FROM 1" TO 3/4"

- Corpo in acciaio al cromo vanadio con superficie cromata
Chrome vanadium steel body with chrome surface
- Attacco quadro incassato
Built-in square drive
- Attacco quadro di collegamento con sfera di fermo
Square connection connection with stop ball

1"

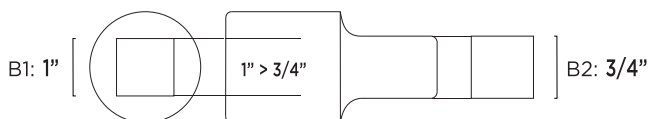

Codice	B1 mm	B2 mm	mm	gr	Icona	Barcode
385501	25	20	71	600	1	8033116547253



386001 PROLUNGA PER CHIAVI A BUSSOLA DA 1" EXTENSION FOR 1" SOCKET WRENCHES

- Corpo in acciaio al cromo vanadio con superficie cromata
Chrome vanadium steel body with chrome surface
- Attacco quadro incassato
Built-in square drive
- Attacco quadro di collegamento con sfera di fermo
Square connection with stop ball

1"



Codice	mm	mm	gr	Icona	Barcode
386001	25	200	1225	1	8033116547260
386002	25	400	2120	1	8033116547277



387001 LEVA SCORREVOLE DA 1" SLIDING LEVER 1"

- Corpo in acciaio al cromo vanadio con superficie cromata lucida
Chrome vanadium steel body with polished chrome surface
- Asta di manovra scorrevole
Sliding operating rod

1"



Codice	mm	mm	gr	Icona	Barcode
387001	25	508	2500	2	8033116547284



Accessori 1000V

1000V accessories



- 1** Impugnatura con isolamento ad immersione a doppio strato per maggiore sicurezza
Double layer immersion insulated handle for added safety

075001 CRICCHETTO REVERSIBILE 1000V DA 1/2"

1/2" REVERSIBLE 1000V RATCHET

- Sfera di sicurezza
Safety sphere
- Leva di inversione integrata
Non-slip rubber handle
- Attacco quadro di collegamento con sfera di fermo
Square connection with stop ball

Codice	mm	mm	gr	📦	Barcode
075001	12,5	250	650	1	8033116537506



070001 CHIAVI A BUSSOLA 1000V DA 1/2"

1/2" 1000V SOCKET WRENCHES

- Attacchi quadro ed esagonale incassati
Recessed square and hexagonal connections

Codice	mm	mm	mm	gr	📦	Barcode
070001	8,0	12,5	57	65	1	8033116537261
070002	10,0	12,5	57	65	1	8033116537278
070003	11,0	12,5	57	65	1	8033116537285
070004	12,0	12,5	57	73	1	8033116537292
070005	13,0	12,5	57	74	1	8033116537308
070006	17,0	12,5	57	86	1	8033116537315
070007	18,0	12,5	57	82	1	8033116537322



Codice	mm	mm	mm	gr	Barcode	
070008	19,0	12,5	57	98	1	8033116537339
070009	22,0	12,5	57	117	1	8033116537346
070010	24,0	12,5	57	142	1	8033116537353
070011	17,0	12,5	57	185	1	8033116537360
070012	30,0	12,5	57	230	1	8033116537377
070013	32,0	12,5	57	280	1	8033116537384

072001 BUSSOLE A GIRAVITE 1000V DA 1/2"

1/2" 1000V SCREWDRIVER SOCKETS

- Con inserto esagonale inserito a pressione
With push-fit hexagonal insert
- Attacco quadro incassato
Built-in square drive

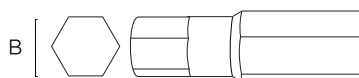

Codice	B1 mm	mm	mm	📦	Barcode
072001	4,0	12,5	55	1	8033116537445
072002	5,0	12,5	55	1	8033116537452
072003	6,0	12,5	55	1	8033116537476
072004	8,0	12,5	55	1	8033116537483



072002L BUSSOLE A GIRAVITE 1000V LUNGHE DA 1/2"
1/2" 1000V LONG SCREWDRIVER SOCKETS

- Con inserto esagonale a pressione
With push-in hexagonal insert
- Attacco quadro incassato
Built-in square drive



Codice	B1 mm	mm	mm	mm	Barcode
072002L	5,0	12,5	100	1	8033116537469
072003L	6,0	12,5	100	1	8033116537483



Fumori
PRO

1/2"

071501 LEVA A "T" 1000V DA 1/2"
1/2" 1000V "T" LEVER

- Bloccaggio e sbloccaggio tramite vite bloccasfera sull'attacco quadro
Locking and unlocking by means of a ball-locking screw on the square coupling
- Asta di manovra fissa
Fixed operating rod

Codice	mm	mm	gr	Barcode
071501	12,5	170	360	1 8033116537438



Fumori
PRO

1/2"

076001 IMPUGNATURA 1000V PER INSERTI DA 1/4"
1000V HANDLE FOR 1/4" INSERTS

Codice	mm	mm	gr	Barcode
076001	6,3	220	98	6 8033116537391



1/4"

Set inserti e bussole

Inserts & sockets set

263301 SET 32 INSERTI DA 1/4"

SET 32 1/4" INSERTS

- ◆ **Inserti da 1/4"** per viti con impronta ad intaglio (3-4-5-5,5-6,5mm) ●
1/4" bits for slotted screws (3-4-5-5.5-6.5mm)
- ◆ **Inserti da 1/4"** per viti con impronta a croce "Phillips" (1-2x2-3mm) ⊕
1/4" bits for "Phillips" screws (1-2-2-3mm)
- ◆ **Inserti da 1/4"** per viti con impronta a croce "Pozidriv" (1-2x2-3mm) ⊕
1/4" bits for "Pozidriv" cross head screws (1-2-2-3mm)
- ◆ **Inserti da 1/4"** per viti con impronta esagonale (2-2,5-3-4-5-6-7mm) ○
1/4" bits for hex head screws (2-2.5-3-4-5-6-7mm)
- ◆ **Inserti da 1/4"** per viti con impronta a croce "Torx" (8-9-10-15x2-20x2-25x2-27-30-40mm) ⊗
1/4" bits for "Torx" cross head screws (8-9-10-15x2-20x2-25x2-27-30-40mm)

Codice		gr	Barcode
263301		1	8033183556103
263301E	Espositore /Exhibitor pz. 18 art. 263301	1	8033183559340



1/4"

06

263102 SET 122 INSERTI DA 1/4"

SET 122 1/4" INSERTS

- ◆ Impugnatura magnetica da 200mm con rivestimento antiscivolo per inserti da 1/4"
Magnetic handle (200mm) with non-slip coating for 1/4" inserts
- ◆ Adattatori per inserti da 1/4"
Adapters for 1/4" inserts
- ◆ **Set di bussole italiane da 1/4"**: Attacco esagonale incassato ○
(4-5-6-7-8-9-10-11-12-13mm)
1/4" italian socket set: Hex socket drive (4-5-6-7-8-9-10-11-12-13mm)
- ◆ **Set di bussole americane da 1/4"**: Attacco esagonale incassato ○
(5/32-3/16-7/32-1/4-9/32-5/16-11/32-3/8-7/16-1/2mm)
1/4" american socket set: Hex socket drive (5/32-3/16-7/32-1/4-9/32-5/16-11/32-3/8-7/16-1/2mm)
- ◆ **Inserti da 1/4"**: per viti con impronta ad intaglio, a croce "Phillips", a croce "Pozidriv", "Torx", "Torx" con foro, "Torx" con foro 5 punte, attacco quadro, attacco esagonale (mm e pollici), attacco esagonale con foro, attacco poligonale, punta biforcata, punta a 3 pale, punta a 4 pale, profilo clutch
1/4" bits: for slotted screws, "Phillips" cross head, cross "Pozidriv", "Torx", "Torx" with hole, "Torx" with hole 5 points, square drive, hexagonal drive (mm and inch), hexagonal drive with hole, polygonal attachment, forked tip, 3-blade tip, 4-blade tip, clutch profile



Codice	gr	gr	Barcode
263102	1200	10	8033116547741



1/4"

263201 SET 99 INSERTI DA 1/4"
SET 99 1/4" INSERTS

- Giravite magnetico nano da 1/4"
1/4" Nano Magnetic Screwdriver
- Cricchetto reversibile da 1/4"
1/4" reversible ratchet
- Portainseri magnetico da 1/4"
Magnetic bit holder 1/4"
- Adattatore per bussole da 1/4"
1/4" socket adapter

- **Inserti da 1/4"**: per viti con impronta ad intaglio, a croce "Phillips", a croce "Pozidriv", "Torx", "Torx" con foro, attacco esagonale (mm e pollici), attacco esagonale con foro (mm e pollici) attacco poligonale, attacco quadro, punta biforcuta, punta a 3 pale, punta a 4 pale, profilo clutch



1/4" bits: for slotted screws, "Phillips" cross head, cross "Pozidriv", "Torx", "Torx" with hole, hexagonal connection (mm and inch), hex shank with hole (mm and inch) polygonal attachment, square attachment, forked tip, 3-blade tip, 4-blade tip, clutch profile

Codice	gr		Barcode
263201	700	10	8033116547734



1/4"

360173 SET 173 PEZZI ASSORTITI
SET 173 ASSORTED PIECES

- Cricchetti reversibili da 1/4"- 1/2" (145mm - 250mm)
1/4-1/2" reversible ratchets (145mm - 250mm)
- Impugnature per inserti con attacco esagonale incassato da 1/4" (100mm) e attacco quadro da 1/2" (150mm)
Handles for 1/4" (100mm) hex socket inserts and with 1/2" square drive (150mm)
- Snodo cardanico da 1/4"- 1/2"
1/4-1/2" cardan joint
- Leve a "T" scorrevoli da 1/4"- 1/2" (1110m - 250mm)
1/4- 1/2" sliding "T" levers (1110m - 250mm)
- Prolunghe per inserti da 1/4"-1/2"
Extensions for 1/4"-1/2" inserts
- **Serie chiavi combinate** (5,5-6-7-8-9-10-11-12-13-14-15-16-17-18-19-22mm)
Combination spanner set (5,5-6-7-8-9-10-11-12-13-14-15-16-17-18-19-22mm)
- **Set di bussole da 1/4"**: Attacco esagonale incassato (4-4,5-5-5,5-6-7-8-9-10-11-12-13-14mm)
1/4" socket Set: Hexagonal socket (4-4.5-5-5.5-6-7-8-9-10-11-12-13-14mm)
- **Set di bussole da 1/2"**: Attacco esagonale incassato (10-13-15-16-17-18-19-20-21-22-24-27-30-32mm)
1/2" socket set: Hexagonal socket (10-13-15-16-17-18-19-20-21-22-24-27-30-32mm)
- **Set di bussole lunghe da 1/2"**: Attacco esagonale incassato (6-7-8-9-10-11-12-13-14-15-17-19mm)
1/2" long socket set: Hex socket drive (6-7-8-9-10-11-12-13-14-15-17-19mm)
- **Set di bussole da 1/2"**: Attacco "Torx" incassato (4-5-6-7-8-10-11-12-14-16-18-20-22-24mm)
1/2" socket set: Recessed" Torx "connection (4-5-6-7-8-10-11-12-14-16-18-20-22-24mm)
- **Inserti da 1/4"**: per viti con impronta ad intaglio, a croce "Phillips", a croce "Pozidriv", "Torx" con foro, attacco esagonale
1/4" bits: for slotted screws, "Phillips" cross head, cross "Pozidriv", "Torx" with hole, hexagonal connection
- Set inserti assortiti + portainserito
Assorted bit set + bit holder
- **Set chiavi a brugola**: Attacco esagonale (1,5-2-2,5-3-4-5-6-8-10mm)
Allen Key Set: Hex Socket (1.5-2-2.5-3-4-5-6-8-10mm)



1/4"

1/2"

Codice	gr		Barcode
360173	9200	1	8033183552556

366002 SET 108 PEZZI ASSORTITI
SET 108 ASSORTED PIECES

1/4" 1/2"

- Cricchetti reversibili da 1/4"- 1/2" (150mm - 250mm)
1/4-1/2" reversible ratchets (150mm - 250mm)
- Impugnatura per inserti con attacco quadro da 1/4" (150mm) ○
Handle for inserts with 1/2 "square drive
- Snodo cardanico da 1/4"- 1/2"
1/4"-1/2" cardan joint
- Leve a "T" scorrevoli da 1/4"- 1/2"
1/4"- 1/2" sliding "T" levers
- Prolunghe per inserti da 1/4"-1/2"
Extensions for 1/4"-1/2" inserts
- Set di bussole da 1/2": Attacco esagonale incassato ○
(10-11-12-13-14-15-16-17-18-19-20-21-22-24-27-30-32mm)
1/2" socket Set: Hexagonal socket (10-11-12-13-14-15-16-17-18-19-20-21-22-24-27-30-32mm)
- Set di bussole lunghe da 1/2": Attacco esagonale incassato ○
(14-15-17-19-22mm)
1/2" long socket set: Hex socket drive (14-15-17-19-22mm)
- Set di bussole da 1/2": Attacco "Torx" incassato (10-11-12-14-16-18-20-24mm) ⊗
1/2" socket set: Recessed" Torx "connection (10-11-12-14-16-18-20-24mm)
- Set di bussole da 1/4": Attacco "Torx" incassato (4-5-6-7-8mm) ⊗
1/2" socket set: Recessed" Torx "connection (4-5-6-7-8mm)
- Inserti da 1/4": per viti con impronta ad intaglio, a croce "Phillips", a croce "Pozidriv", "Torx", attacco esagonale
1/4" bits: for slotted screws, "Phillips" cross head, cross "Pozidriv", "Torx", hexagonal connection
- Chiavi maschio esagonali piegate (1,5-2-2,5) ○
Bent hexagonal male keys (1,5-2-2,5)



Codice	gr	📦	Barcode
366002	7300	1	8033116543972



06

345430 SET 46 CHIAVI A BUSSOLA DA 1/4"
46 1/4" SOCKET WRENCHES SET

1/4"

- Cricchetto reversibile da 1/4"
1/4" reversible ratchet
- Impugnatura quadra a innesto da 1/4" ○
1/4" square plug-in handle
- Prolunghe per chiavi a bussola da 1/4" (150mm - 75mm)
Extensions for 1/4" socket wrenches (150mm - 75mm)
- Leva scorrevole 100mm da 1/4"
1/4" 100mm sliding lever
- Inserto esagonale da 1/4" ○
1/4" hex insert
- Snodo cardanico da 1/4"
1/4" cardan joint
- Set di chiavi a bussola da 1/4": Attacchi quadro ed esagonale incassati (4-5-5,5-6-7-8-9-10-11-12-13mm) ○
1/4" socket wrench set: Square drive and hexagonal socket (4-5-5,5-6-7-8-9-10-11-12-13mm)
- Set di chiavi a bussola lunghe da 1/4": Attacchi quadro ed esagonale incassati (6-7-8-10-11-12-13mm) ○
1/4" long socket wrench set: Square drive and hexagonal socket (6-7-8-10-11-12-13mm)
- Bussole a giravite da 1/4": inserto inserito a pressione per viti con impronta ad intaglio, impronta a croce "Phillips", profilo esagonale, profilo poligonale, profilo "Torx" con foro
1/4" screwdriver sockets: press-fit insert for slotted screws, "Phillips" recess, hexagonal profile, polygonal profile, "Torx" profile with hole



Codice	📦	Barcode
345430	1	8033116543453



366001 SET 23 CHIAVI A BUSSOLA DA 1/2"
SET 23 1/2" SOCKET WRENCHES

1/2"

- Cricchetto reversibile da 1/2" (250mm)
1/4-1/2" reversible ratchets (145mm - 250mm)
- Barra di estensione da 1/2" (125 - 250mm)
1/2 "extension bar (125 - 250mm)
- Snodo cardanico da 1/2"
1/2" cardan joint
- Leve a "T" scorrevoli da 1/2" (250mm)
1/2" sliding" T "levers (250mm)
- Impugnatura per inserti con attacco da 1/2"
Handle for inserts with 1/2" connection
- **Set di bussole da 1/2"**: Attacco esagonale incassato
(8-10-11-12-13-14-15-16-17-18-19-20-21-22-24-27-30-32mm)
1/2" socket set: Hexagonal socket (8-10-11-12-13-14-15-16-17-18-19-20-21-22-24-27-30-32mm)



Codice	gr		Barcode
366001	5400	1	8033116543965

GAMMA COMPLETA PER OGNI ESIGENZA

COMPLETE RANGE FOR EVERY NEED



LINEA PRO
PRO LINE

161 Giratubi
Pipe wrenches

164 Pinze per tubi
Pipe clamps

166 Taglio e preparazione
Cutting and preparation

177 Curvatura e saldatura
Bending and welding

185 Manutenzione e riparazione tubi
Maintenance and repair pipes

194 Set di utensili per idraulici
Set of tools for plumbers

07

Giratubi e pinze per tubi

Pipe wrenches & pliers for pipes

Giratubi

Pipe wrenches

- 1** Corpo in acciaio al cromo vanadio di qualità che offre la massima robustezza rifinito tramite processo di verniciatura.

Quality chrome vanadium steel body offering maximum strength finished by painting process.
- 2** Regolazione a dado zigrinato, rinforzato, per facilitare il bloccaggio del giratubo nella posizione desiderata tramite l'utilizzo di una sola mano.

Knurled nut adjustment, reinforced, to facilitate locking the pipe wrench in the desired position by using only one hand.
- 3** Ganasce in lega di acciaio con denti fresati per massimizzare la forza di presa.

Alloy steel jaws with milled teeth to maximize gripping force.

500001 GIRATUBI UNIVERSALE SVEDESE A DUE MANICI UNIVERSAL TWO HANDLE PIPE WRENCH

- ◆ Ganasce piegate a 90°
90° bent jaws

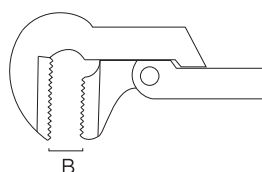

Codice	B pollici	B mm	mm	gr		Barcode
500001	1"	35	320	800	1	8033116532433
500002	1½"	50	410	1300	1	8033116532440
500003	2"	62	550	2300	1	8033116547758
500004	3"	80	650	3150	1	8033116547765
500005	4"	100	750	4200	1	8033183845887

501001 GIRATUBI UNIVERSALE SVEDESE A DUE MANICI UNIVERSAL TWO HANDLE PIPE WRENCH

- ◆ Ganasce piegate a 45°
45° bent jaws

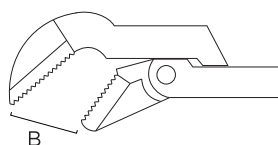

Codice	B pollici	B mm	mm	gr		Barcode
501001	½"	22	250	400	1	8033116531023
501002	1"	35	320	800	1	8033116531030
501003	1½"	50	410	1300	1	8033116532518
501004	2"	62	550	2550	1	8033116532525
501005	3"	80	650	4100	1	8033116547772

500051 GIRATUBI COMBINATO SVEDESE A DUE MANICI COMBINED TWO HANDLE SWEDISH PIPE WRENCH

- Ganasce a "S"
"S" jaws
- Adatto per la presa di oggetti tondi ed esagonali
Suitable for gripping round and hexagonal objects

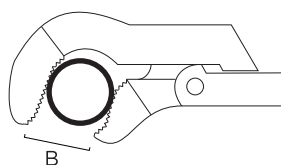

Codice	B pollici	B mm	mm	gr		Barcode
500051	½"	22	240	400	1	8033116532464
500052	1"	35	320	900	1	8033116532471
500053	1½"	50	400	1500	1	8033116532488
500054	2"	62	550	2550	1	8033116532495
500055	3"	80	650	4200	1	8033116532501

504001 GIRATUBI AMERICANO PER IMPIEGHI PESANTI AMERICAN PIPE WRENCH FOR HEAVY DUTIES

- Corpo monoblocco in ghisa
Cast iron monoblock body

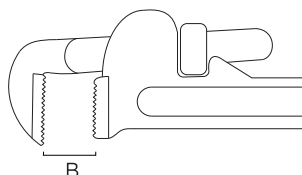

Codice	B pollici	B mm	mm	gr		Barcode
504001	½"	34	200	400	1	8033116547819
504002	1"	48	250	780	1	8033116532532
504003	2"	60	350	1500	1	8033116532549
504004	2½"	76	450	2370	1	8033116532556
504005	3"	88	600	4000	1	8033116547826
504006	5"	125	900	5400	1	8033116547833
504007	6"	140	1200	9900	1	8033116547840

505001 GIRATUBI AMERICANO PER IMPIEGHI PESANTI AMERICAN PIPE WRENCH FOR HEAVY DUTIES

- Corpo monoblocco in alluminio
Aluminum monoblock body
- Modello leggero
Lightweight model

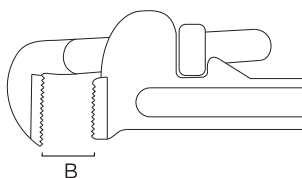

Codice	B pollici	B mm	mm	gr		Barcode
505001	2"	51	350	1000	1	8033116532570
505002	2½"	64	450	1660	1	8033116532587
505003	3"	76	600	2270	1	8033116544429
505004	5"	125	900	4800	1	8033116547062

506001 GIRATUBI MODELLO LEGGERO
LIGHT MODEL PIPE WRENCH

- Ganasce piagate a 90°
90° wound jaws

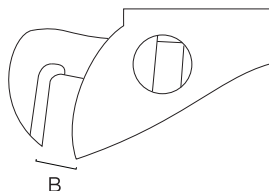

Codice	B pollici	B mm	mm	gr		Barcode
506001	1"	45	175	330	1	8033116547864
506002	1½"	60	225	580	1	8033116532594
506003	2"	75	275	800	1	8033116531733
506004	2½"	85	300	1000	1	8033116547871
506005	3"	100	350	1100	1	8033116547888

506001PK GIRATUBI MODELLO LEGGERO PROFESSIONALE
PROFESSIONAL LIGHT MODEL PIPE WRENCH

- Ganasce piegate a 90°
90° bent jaws
- Tipo PKS
PKS type

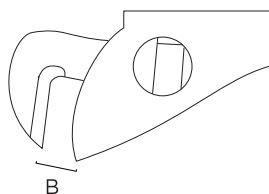

Codice	B pollici	B mm	mm	gr		Barcode
506001PK	1"	45	175	330	1	8033183555830
506002PK	1½"	60	225	580	1	8033183555847
506003PK	2"	75	275	800	1	8033183555991
506004PK	2½"	85	300	1000	1	8033183556189
506005PK	3"	100	350	1100	1	8033183560834

506001PKC GIRATUBI MODELLO LEGGERO CURVO PROFESSIONALE
PROFESSIONAL CURVED LIGHT MODEL PIPE WRENCH

- Ganasce piegate a 45°
45° bent jaws
- Tipo PKS curvo
Curved PKS type

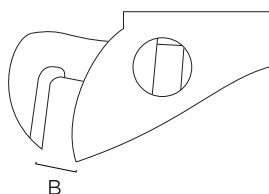

Codice	B pollici	B mm	mm	gr		Barcode
506001PKC	1"	45	175	330	1	8033183555977
506002PKC	1½"	60	225	580	1	8033183555984
506004PKC	2"	75	300	1000	1	8033183556271

570022 GIRATUBI A CATENA MODELLO LEGGERO
LIGHT MODEL CHAIN PIPE WRENCH

- Ganasce con profilo a doppia dentatura
Jaws with double toothed profile
- Catena ad alta resistenza
High strength chain

Codice	Ø (MAX) mm	mm	gr		Barcode
570022	115	300	800	2	8033183554581



Pinze per tubi

Pipe clamps

- 1** **Meccanismo per regolare l'apertura, preciso e affidabile; permette il bloccaggio e l'adattamento ottimale alle diverse dimensioni del pezzo.**
Mechanism to adjust the opening, precise and reliable; allows locking and the optimal adaptation to the different dimensions of the piece.
- 2** **Ganasce con doppia zigrinatura per una presa ottimale**
Double knurled jaws for optimal grip
- 3** **I manici distanziati garantiscono un miglior comfort e una maggior potenza di trasmissione per il serraggio di tubi.**
The spaced handles ensure better comfort and greater power transmission for clamping pipes.

167350 PINZA REGOLABILE A PULSANTE RAPIDO ADJUSTABLE CALIPER WITH QUICK BUTTON

- ♦ Corpo in acciaio al cromo vanadio con finitura brunita
Chrome vanadium steel body with burnished finish
- ♦ Manici plastificati antiscivolo
Non-slip plasticized handles
- ♦ Regolazione tramite pulsante
Adjustment with push button

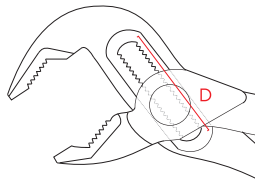

Codice	Campo di lavoro / Working range (D) mm	mm	gr		Barcode
167350	0 - 40	180	190	6	8033116547789
167351	0 - 60	240	300	6	8033116547796
167352	0 - 70	300	530	6	8033116547802
167350E	Espositore / Exhibitor	6 x 167350 - 167351		1	8033183562104
167351E	Espositore / Exhibitor	12 x 167351		1	8033183568755

167505 PINZA REGOLABILE A CERNIERA CHIUSA CLOSED HINGE ADJUSTABLE CLAMP

- ♦ Corpo in acciaio al cromo vanadio con finitura brunita
Chrome vanadium steel body with burnished finish
- ♦ Manici plastificati antiscivolo
Non-slip plasticized handles

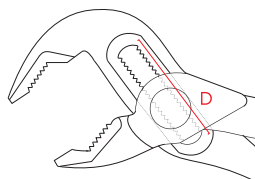

Codice	Campo di lavoro / working range (D) mm	mm	gr		Barcode
167504	0 - 37	175	155	6	8033183554826
167505	0 - 55	240	330	6	8033116536080
167506	0 - 65	300	530	6	8033183586643
224645	Espositore / Exhibitor	12 x 167505		1	8033116536387

167200 PINZA REGOLABILE A CERNIERA CHIUSA
CLOSED HINGE ADJUSTABLE CLAMP

- Corpo in acciaio al cromo vanadio con finitura verniciata
Chrome vanadium steel body with painted finish

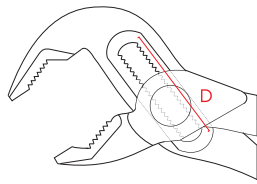

Codice	Campo di lavoro / Working range (D) mm	mm	gr		Barcode
167200	3 - 30	175	174	6	8033116536059
167201	3 - 40	240	310	6	8033116536066
167202	3 - 45	300	550	6	8033116532624
224204	Espositore / Exhibitor 5 x 167200 - 15 x 167201 5 x 167202			1	8033116536431

560001 PINZA REGOLABILE PER SIFONI
ADJUSTABLE PLIERS FOR SIPHONS

- Corpo in acciaio temperato ad induzione con esecuzione cromata
Induction hardened steel body with chromed execution
- Ganasce dentate e rivestite in plastica per sifoni e tubi cromati
Toothed and plastic coated jaws for siphons and chrome pipes

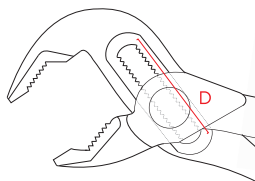

Codice	Campo di lavoro / working range (D) mm	mm	gr		Barcode
560001	3 - 50	235	264	5	8033116547857

223001 PINZA PER RUBINETTI
ADJUSTABLE PLIERS FOR SIPHONS

- Corpo in acciaio al carbonio con esecuzione verniciata sabbata
Carbon steel body with sandblasted painted finish
- Impugnatura ricoperta di materiale plastico antiscivolo
Non-slip plastic handle
- Ideale per l'installazione di dadi e bulloni di diametro massimo 12" in posti stretti
Ideal for installing nuts and bolts with a maximum diameter of 12" in narrow places

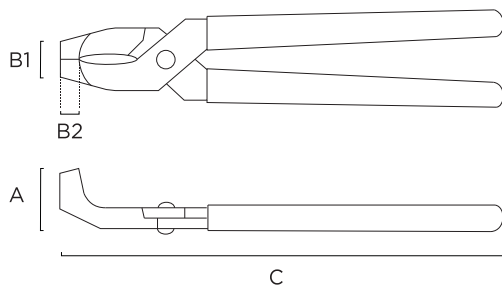

Codice	B1 x B2 mm	A mm	C mm	gr		Barcode
223001	23 x 11	32	250	495	5	8033116547994

Taglio e preparazione dei tubi

Pipe cutter & pipe preparation

Tagliatubi

Pipe cutter

- 1** **Corpo in acciaio con esecuzione verniciata per una lunga durata.**
Steel body with painted finish for long life.
- 2** **Presenta un meccanismo di avanzamento per un taglio regolare tramite vite e una manopola zigrinata per l'adattamento del tubo in un movimento fluido e continuo.**
Features a feed mechanism for smooth cutting via screw and a knurled knob for tube adaptation in a smooth and continuous movement.
- 3** **Rotella di taglio in acciaio con leghe ad alta resistenza per consentire un taglio pulito e preciso.**
Steel cutting wheel with high resistant alloys for clean and precise cut.

507001 TAGLIATUBI PER IMPIEGHI PESANTI PIPE CUTTERS FOR HEAVY DUTIES

- Due rulli larghi per una guida precisa della rotella nel tubo
Two wide rollers for precise guide of the wheel in the tube
- Per tubi in acciaio e ghisa
For steel and cast iron pipes

Codice	Capacità di taglio / Cutting capacity pollici	mm	mm	gr		Barcode
507002	1/8" - 1"-1/4"	3 - 25	275	350	2	8033183551795
507001	1/8" - 2"	3 - 50	380	800	1	8033116532679



507601 TAGLIATUBI CON AVANZAMENTO A VITE PIPE CUTTERS FOR HEAVY DUTIES

- Dotato di manopola ergonomica
Equipped with an ergonomic knob
- Per tubi in rame e leghe leggere
For copper and light alloy pipes

Codice	Capacità di taglio / Cutting capacity pollici	mm	mm	gr		Barcode
507601	1/8" - 1"-1/8"	3 - 30	150	290	5	8033116531719



507003 TAGLIATUBI CON AVANZAMENTO RAPIDO PIPE CUTTERS FOR HEAVY DUTIES

- Dotato di manopola ergonomica
Equipped with an ergonomic knob
- Modello a cremagliera, rientro immediato con molla
Rack model, immediate back with spring
- Per tubi in rame, leghe leggere e plastica
For light alloy copper and plastic pipes

Codice	Capacità di taglio / Cutting capacity pollici	mm	mm	gr		Barcode
507003	1/4" - 2"-5/8"	6 - 67	215	600	2	8033183551801
507004	2" - 5"	50 - 127	335	2100	2	8033183551818



507701 TAGLIATUBI CON AVANZAMENTO RAPIDO PIPE CUTTERS FOR HEAVY DUTIES

- Dotato di manopola ergonomica
Equipped with an ergonomic knob
- Modello ad avanzamento telescopico
Telescopic feed model
- Per tubi in rame
For copper pipes

Codice	Capacità di taglio / Cutting capacity pollici	mm	mm	gr		Barcode
507701	1/8" - 1"-1/4"	3 - 30	135	280	2	8033116532662
507702	1/8" - 1"-1/4"	3 - 42	175	650	2	8033183552150



507702I TAGLIATUBI CON AVANZAMENTO RAPIDO PER INOX QUICK FEED PIPE CUTTERS FOR STAINLESS STEEL

- Dotato di manopola ergonomica
Equipped with an ergonomic knob
- Modello ad avanzamento telescopico
Telescopic feed model
- Per tubi in acciaio INOX
Stainless steel pipes

Codice	Capacità di taglio / Cutting capacity pollici	mm	mm	gr		Barcode
507702I	1/4" - 1"-3/4"	6 - 45	140	300	2	8033183573117



507501 TAGLIATUBI MODELLO TASCABILE POCKET MODEL CUTTERS

- Progettato per l'utilizzo in ambienti stretti e su piccoli tubi
Designed for use in narrow environments and on small pipes
- Dotato di manopola ergonomica
Equipped with an ergonomic knob
- Per tubi in rame e leghe leggere
For copper and light alloy pipes

Codice	Capacità di taglio / Cutting capacity pollici	mm	mm	gr		Barcode
507501	1/8" - 5/8"	3 - 22	56	105	10	8033183552808



ROTELLE DI RICAMBIO
SPARE WHEELS

- ♦ Corpo in lega di acciaio
Steel alloy body

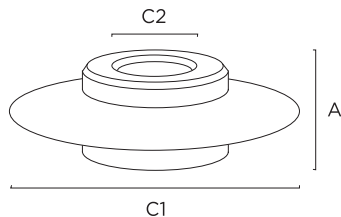

Codice	C1 mm	C2 mm	A mm	Tagliatubo / Pipe cutter	Materiale / Material					Barcode	
					PVC	Alluminio/ Aluminum	Acciaio/ Steel	Rame/ copper	Inox/ Stainless steel		
507001A	26	8	14	507002			•			3	8033183557841
507002B	31	9	19	507001			•			3	8033183564764
507003L	18	5	6	507003 507702		•		•		5	8033183554949
507003R	22	5	6	507003	•					5	8033183555489
507004L	42	8	11	507004	•					5	8033183554956
507801	18	4	3	507501 507601 507701		•		•		5	8033116548175
507801-I	18	4	3	507501 507601 507701					•	6	8033183577221
507801I	18	4	6	507702 507702I					•	6	8033183570567

231401 CESCOIE PER TUBI A CREMAGLIERA
RACK PIPE SHEARS

- ♦ Funzionamento a cricco per ottenere una maggiore forza di taglio
Ratchet operation to achieve greater cutting force with less effort
- ♦ Apertura manuale della lama dopo il taglio
Manual blade opening after cutting
- ♦ Gancio di chiusura al termine del taglio
Closing hook at the end of the cut
- ♦ Per tubi in plastica, gomma, PVC-CPVC-PEX-PE-PB
For plastic, rubber, PVC-CPVC-PEX-PE-P pipes

Codice	Ø (MAX) mm	mm	gr	📦	Barcode
231401	42	200	300	6	8033116534109



231410 CESCOIE PER TUBI AUTOMATICHE A CREMAGLIERA
AUTOMATIC RACK PIPE SHEARS

- ♦ Funzionamento a cricco per ottenere una maggiore forza di taglio
Ratchet operation to achieve greater cutting force with less effort
- ♦ Apertura automatica della lama dopo il taglio
Automatic blade opening after cutting
- ♦ Gancio di chiusura al termine del taglio
Closing hook at the end of the cut
- ♦ Per tubi in plastica, gomma, multistrato, PVC-CPVC-PEX-PE-PB
For plastic, rubber, multilayer, PVC-CPVC-PEX-PE-PB pipes

Codice	Ø (MAX) mm	mm	gr	📦	Barcode
231410	42	230	500	12	8033116532181



231415 CESCOIE PER TUBI A CREMAGLIERA
RACK PIPE SHEARS

- Funzionamento a cricco per ottenere una maggiore forza di taglio
Ratchet operation to achieve greater cutting force with less effort
- Apertura manuale della lama dopo il taglio
Manual blade opening after cutting
- Gancio di chiusura al termine del taglio
Closing hook at the end of the cut
- Per tubi in plastica e in gomma
For plastic and rubber hoses

Codice	Ø (MAX) mm	mm	gr		Barcode
231415	63	425	1050	2	8033116532648



231405 CESCOIE PER TAGLIO A SINGOLO SCATTO
SINGLE-SNAP CUTTERS

- Funzionamento a taglio diretto
Direct cut operation
- Apertura manuale della lama dopo il taglio
Manual opening of the blade after cutting
- Gancio di chiusura al termine del taglio
Closing hook at the end of the cut
- Per tubi in plastica, PVC, PVR e PE
For plastic, PVC, PVR and PE pipes

Codice	Ø (MAX) mm	mm	gr		Barcode
231405	36	190	300	6	8033183590305



231420 CESCOIE AD AVANZAMENTO A CRICCO
RATCHET FEEDING SHEARS

- Funzionamento a cricco per ottenere una maggiore forza di taglio
Ratchet operation to achieve greater cutting force with less effort
- Lama intercambiabile e retrattile in qualsiasi posizione
Interchangeable and retractable blade in any position
- Sforzo minimo grazie alla speciale geometria dei taglienti e del manico
Minimum effort thanks to the special geometry of the cutting edges and the handle
- Per tubi in plastica e gomma
For plastic and rubber hoses

Codice	Ø (MAX) mm	mm	gr		Barcode
231420	35	190	600	2	8033183551788



Svasatori

Countersinks

570044 SBAVATORE CALIBRATORE TRIPLO TRIPLE CALIBRATOR DEBURRER

- ♦ Corpo in ABS rigido
Rigid ABS body
- ♦ Svasatura e calibrazione di tubi multistrato
Flaring and calibration of multilayer pipes

Codice	Capacità di taglio / Cutting capacity	Ø mm	mm	gr		Barcode
570044	14 - 32		110	180	10	8033183596864

570045 SBAVATORE CALIBRATORE TRIPLO CON LAME TRIPLE CALIBRATING DEBURRER WITH BLADES

- ♦ Corpo in ABS rigido
Rigid ABS body
- ♦ Svasatura e calibrazione di tubi multistrato
Flaring and calibration of multilayer pipes

Codice	Capacità di taglio / Cutting capacity	Ø mm	mm	gr		Barcode
570045	16 - 26		100	160	5	8033183596871

508130 SBAVATORE CALIBRATORE TRIPLO PROFESSIONALE PROFESSIONAL TRIPLE CALIBRATOR DEBURRER

- ♦ Taglienti in acciaio
Steel cutting edges
- ♦ Svasatura e calibrazione di tubi multistrato
Flaring and calibration of multilayer pipes

Codice	Capacità di taglio / Cutting capacity	Ø mm	mm	gr		Barcode
508130	16 - 32		140	243	1	8033183558589

508130P SBAVATORE CALIBRATORE TRIPLO PROFESSIONALE PROFESSIONAL TRIPLE CALIBRATOR DEBURRER

- ♦ Corpo in materiale plastico
Cover in plastic material
- ♦ Svasatura e calibrazione di tubi in rame
Flaring and calibration of copper pipes

Codice	Capacità di taglio / Cutting capacity	Ø mm	mm	gr		Barcode
508130P	16 - 26		110	167	1	8033183561664



508131 SBAVATORE A RASCHIETTO CON PORTALAMA
SCRAPER WITH BLADE HOLDER

- ♦ Lama intercambiabile girevole in acciaio HSS
Swiveling interchangeable blade in HSS steel
- ♦ Sbavatura interna di tubi in rame, plastica e multistrato
Internal deburring of copper, plastic and multilayer pipes
- ♦ Fornito con 2 lame
Supplied with 2 blades

Codice	Ø mm	mm	gr		Barcode
508131	22	150	50	1	8033183576026



570048 SBAVATORE UNIVERSALE PER TUBI IN PLASTICA
UNIVERSAL DEBURRER FOR PLASTIC PIPES

- ♦ Placchetta di taglio in acciaio trattato termicamente
Cutting plate in heat treated steel
- ♦ Per sbavare contemporaneamente interno ed esterno di tubi di scarico e ad imbocco in PE, PP, PVC
For simultaneous deburring inside and outside drain pipes and inlet pipes in PE, PP, PVC

Codice	Capacità di taglio / Cutting capacity	Ø mm	mm	gr		Barcode
570048	25 - 110	110			1	8033183561831



508125 SBAVATORE UNIVERSALE PER TUBI IN RAME
UNIVERSAL DEBURRER FOR PLASTIC PIPES

- ♦ Corpo in acciaio ricoperto in PVC
Steel body covered in PVC
- ♦ Tre coltelli in acciaio temprato per levigare le superfici senza scanalature
Three hardened steel knives to smooth surfaces without grooves
- ♦ Per sbavare contemporaneamente interno ed esterno tubi in rame, alluminio e acciaio dolce
To deburr inside and outside copper pipes at the same time, aluminum and mild steel

Codice	Capacità di taglio / Cutting capacity	Ø mm	mm	gr		Barcode
508125	6 - 40	55	300	5		8033116532600



508126 SBAVATORE UNIVERSALE PER TUBI IN RAME
UNIVERSAL DEBURRER FOR PLASTIC PIPES

- ♦ Corpo in acciaio cromato
Chromed steel body
- ♦ Tre coltelli in acciaio temprato per levigare le superfici senza scanalature
Three hardened steel knives to smooth surfaces without grooves
- ♦ Per sbavare contemporaneamente interno ed esterno di tubi in acciaio inossidabile, acciaio, rame, alluminio, plastica e multistrato
For simultaneous internal and external deburring of stainless steel pipes, steel, copper, aluminum, plastic and multilayer

Codice	Capacità di taglio / Cutting capacity	Ø mm	mm	gr		Barcode
508126	8 - 38	60	300	3		8033183554468
508127	10 - 54	75	450	3		8033183554475



508132 SBAVATORE CALIBRATORE MULTIMISURA
MULTI-SIZE CALIBRATOR DEBURRER

- Corpo a sezione cilindrica in acciaio speciale temprato e brunito
Special hardened and burnished steel body with cylindrical section
- Per sbavare la parte interna del tubo multistrato e 6 misure per ricalibrare il diametro interno dopo il taglio
To deburr the inside of the multilayer pipe and 6 measures to recalibrate the inside diameter after cutting

Codice	Capacità di taglio / Cutting capacity	Ø mm	mm	gr		Barcode
508132	(14-16-18-20) x 2 - (26-32) x 3		150	300	2	8033153579850

Fumori
PRO**508132P** SBAVATORE CALIBRATORE MULTIMISURA
MULTI-SIZE CALIBRATOR DEBURRER

- Corpo in acciaio speciale temprato e brunito
Special hardened and burnished steel body
- Per sbavare la parte interna del tubo multistrato e 4 misure per ricalibrare il diametro interno dopo il taglio
To deburr the inside of the multilayer pipe and 4 measures to recalibrate the inside diameter after cutting

Codice	Capacità di taglio / Cutting capacity	Ø mm	mm	gr		Barcode
508132P	(16-20) x 2 - (26-32) x 3		150	300	2	8033153579850

Fumori
PRO**508132PC** SBAVATORE CALIBRATORE MULTIMISURA GIREVOLE
REVOLVING MULTI-SIZE CALIBRATOR DEBURRER

- Corpo in acciaio speciale temprato e brunito
Special hardened and burnished steel body
- Per sbavare la parte interna del tubo multistrato e 4 misure per ricalibrare il diametro interno dopo il taglio
To deburr the inside of the multilayer pipe and 4 measures to recalibrate the inside diameter after cutting
- Meccanismo a cricchetto girevole
Swivel ratchet mechanism

Codice	Capacità di taglio / Cutting capacity	Ø mm	mm	gr		Barcode
508132PC	(16-20) x 2 - (26-32) x 3		145	300	2	8033183580061

Fumori
PRO**508134** SBAVATORE CALIBRATORE MULTIMISURA EXTRA
EXTRA MULTI-SIZE CALIBRATOR DEBURRER

- Corpo a sezione cilindrica in acciaio speciale temprato e brunito
Special hardened and burnished steel body with cylindrical section
- Per sbavare la parte interna del tubo multistrato e 3 misure per ricalibrare il diametro interno dopo il taglio
To deburr the inside of the multilayer pipe and 3 measures to recalibrate the inside diameter after cutting

Codice	Capacità di taglio / Cutting capacity	Ø mm	mm	gr		Barcode
508134	40 x 3,5 - 50 x 4 - 63 x 4,5		120	320	1	8033183831088



570062 SBAVATORE CALBRATORE MULTIMISURA
MULTI-SIZE CALIBRATOR DEBURRER

- Corpo in plastica dura
Hard plastic body
- Per sbavare la parte interna del tubo multistrato e 6 misure per ricalibrare il diametro interno dopo il taglio
To deburr the inside of the multilayer pipe and 6 measures to recalibrate the inside diameter after cutting

Codice	Capacità di taglio / Cutting capacity	Ø mm	mm	gr		Barcode
570062	(14-16-18-20) x 2 - (26-32) x 3		150	200	10	8033183596932



570036 SET 12 ALESATORI PER UGELLI
NOZZLE REAMER SET

- Acciaio speciale per utensili
Special tool steel
- Completo di impugnatura a cilindro con raccordo di serraggio lame
Complete with cylinder handle with blade clamping connection

Codice	Ø mm	mm	gr		Barcode
570036	0,6 - 1,9	125 x 10	25	1	8033183576323



570057 SBAVATORE ESTERNO PER TUBI IN PLASTICA
EXTERNAL DEBURRER FOR PLASTIC PIPES

- Impugnature regolabili a frizione
Adjustable friction handles
- Realizza smussature a 15° all'esterno dei tubi in plastica
Make 15° bevels on the outside of plastic pipes
- Superficie a basso attrito per smussature più agevoli, con possibilità di regolare diametro e altezza rendendolo flessibile e universale
Low friction surface for easier chamfering, with the option of adjust diameter and height making it flexible and universal

Codice	Capacità di taglio / Cutting capacity	Spessore max / Max thickness	mm	gr		Barcode
570057-1	16 - 110	15	235	785	1	8033183558367
570057-2	40 - 250	20	235	800	1	8033183558374



Utensili da taglio

Cutting tools

180001 SEGHETTO PER METALLI CON LAMA SAW FOR METALS WITH BLADE

- Corpo ad asta rettangolare in lega di alluminio verniciato rosso
Rectangular rod body in red painted aluminum alloy
- Impugnatura ergonomica in alluminio verniciato
Ergonomic aluminum painted handle
- Con dispositivo tendilama a galletto, per lame da metallo da 30mm
With wing nut tensioner, for 30mm metal blades

Codice	mm	gr		Barcode
180001	450	500	6	8033183550637



181001 SEGHETTO PER METALLI CON LAMA SAW FOR METALS WITH BLADE

- Corpo ad asta rettangolare in lega di alluminio verniciato rosso
Rectangular rod body in red painted aluminum alloy
- Impugnatura in legno verniciato naturale
Wooden painted handle
- Con dispositivo tendilama a galletto, per lame da metallo da 30mm
With wing nut tensioner, for 30mm metal blades

Codice	mm	gr		Barcode
181001	530	420	6	8033116531191



181501 SEGHETTO LEGGERO PER METALLO E LEGNO LIGHT METAL AND WOOD SAW

- Mini seghetto modello leggero in acciaio trafilato
Light model mini hacksaw in drawn steel
- Comoda impugnatura in plastica a pistola per un maggior comfort
Comfortable plastic pistol grip for greater comfort
- Con dispositivo tendilama a galletto, per lame PUK da 150mm
With wing nut tensioner device, for 150mm PUK blades

Codice	mm	gr		Barcode
181501	240	180	12	8033183550644



182001 SEGHETTO LEGGERO PER METALLO E LEGNO LIGHT METAL AND WOOD SAW

- Mini seghetto modello leggero in acciaio trafilato
Light model mini hacksaw in drawn steel
- Per lame PUK da 150mm
For PUK 150mm blades

Codice	mm	gr		Barcode
182001	240	100	12	8033116531061



181503 SEGHETTO LEGGERO PROFESSIONALE PROFESSIONAL LIGHTWEIGHT SAW

- ♦ Mini seghetto modello leggero in acciaio trafilato
Light model mini hacksaw in drawn steel
- ♦ Impugnatura in legno verniciato naturale
Wooden painted handle
- ♦ Per lame PUK da 150mm
For PUK 150mm blades



Codice	mm	gr		Barcode
181503	270	120	12	8033183576682

670032 IMPUGNATURA PER LAME FLESSIBILI HANDLE FOR FLEXIBLE BLADES

- ♦ Impugnatura in plastica di alta qualità per lame bimetalliche con maniglia di guida zincata
High quality plastic handle for bimetal blades with galvanized guide handle
- ♦ Dado zigrinato aderente per la massima forza di tenuta della lama della sega
Tight knurled nut for maximum blade holding force of the saw
- ♦ Modificazione e montaggio lama senza uso di utensili
Blade modification and assembly without the use of tools
- ♦ Dotato di lama per sega bimetallica PUK da 300 mm 24 TPI
Equipped with PUK 300mm 24 TPI bimetal saw blade



Codice	mm	gr		Barcode
670032	313	161	12	8033183838612

LAME DI RICAMBIO PER SEGHETTI SPARE BLADES FOR SAWS

- ♦ Corpo in acciaio speciale con tagliente in HSS
Special steel body with HSS cutting edge

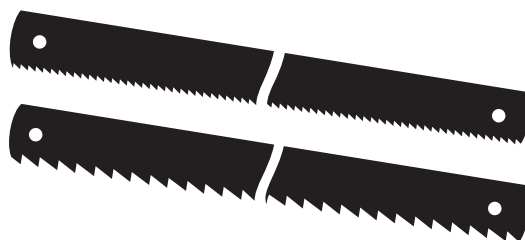

Codice	mm	Seghetto / Hacksaw	Materiale / Material					Barcode
			Ferro / Iron	Rame/ Copper	Alluminio/ Aluminum	Legno/ Wood		
180101	10 /cm	300	180001	•	•	•	10	8033183550651
			181001	•	•	•		
180103	7 /cm	300	180001			•	10	8033183550675
			181001			•		
181502	12 /cm	150	181501	•	•	•	12	8033116531948
			181503	•	•	•		
			182001	•	•	•		
182101	6 /cm	150	181501			•	12	8033183550682
			181503			•		
			182001			•		

570050 PERFORATORE PER POZZETTI DRILL FOR WELLS

- ♦ Corpo in ottone grezzo
Raw brass body
- ♦ 8 denti
8 teeth



Codice	Ø mm	mm		Barcode
570050	38	125	1	8033183556929

560010 FRESA PER RETTIFICA SEDI RUBINETTI
CUTTER FOR GRINDING TAP SEATS

- 3 frese a 24 tagli: 3/8"; 3/4"; 1/2"
3 cutters with 24 cuts: 3/8"; 3/4"; 1/2"
- 3 guarnizioni in gomma
3 rubber gaskets

Codice	mm	gr		Barcode
560010	105	170	5	8033183552105

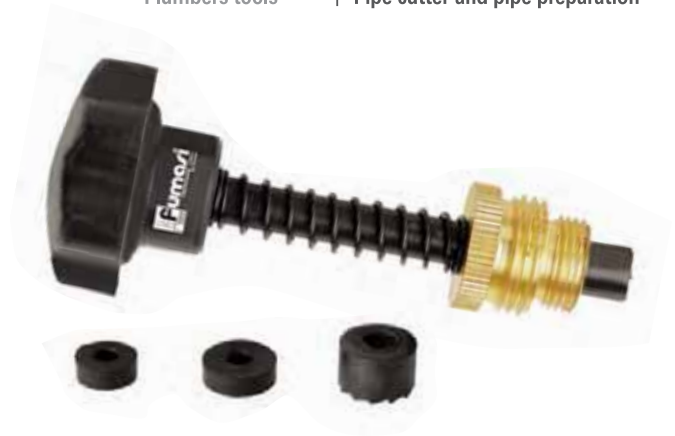
**550001** TRONCABULLONI
BOLT CUTTERS

- Lame realizzate in acciaio forgiato al cromo-molibdeno trattato termicamente, indurito a induzione e forgiato
Forged chromium-molybdenum thermally treated steel blades, hardened and forged by induction
- Taglienti ad alta resistenza che consentono una potenza di taglio efficace
High strength cutting edges that allow for power effective cutting
- Angolo di taglio perfettamente adattato offre una capacità di taglio ideale, in modo da poter tagliare efficacemente anche con poco sforzo
Perfectly adapted cutting angle offers a capacity ideal cutting, so you can cut effectively too with little effort
- Il manico ergonomico con impugnatura antiscivolo completa il rapporto equilibrato tra efficienza di taglio e peso pratico del tagliabulloni
The ergonomic handle with non-slip grip completes the report balanced between cutting efficiency and practical weight of the bolt cutter

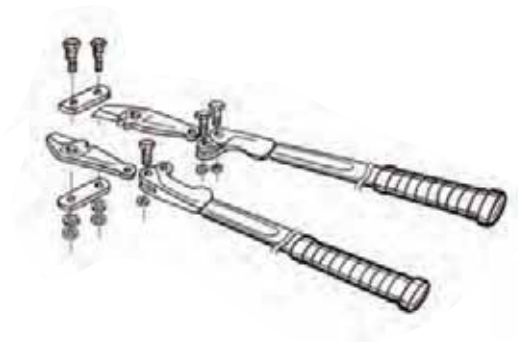

Codice	mm	gr		Barcode
550001	450	1800	1	8033116531351
550002	650	2800	1	8033116531368
550003	750	4000	1	8033116531627
550004	900	5800	1	8033116536448
550005	1090	8500	1	8033116536455
550501	Lama ricambio / Spare blade		1	8033116536479
550502	Lama ricambio / Spare blade		1	8033116536486
550503	Lama ricambio / Spare blade		1	8033116536493
550504	Lama ricambio / Spare blade		1	8033116536509
550505	Lama ricambio / Spare blade		1	8033116536516



Utensili per la curvatura e saldatura dei tubi

Bending tools & pipe welding

Curvatubi

Pipe benders

570032P CURVATUBI PER MULTISTRATO A CRICCO RATCHET PIPE BENDERS FOR MULTILAYER

- Impugnatura in gomma antiscivolo per un comfort di utilizzo prolungato
Non-slip rubber handle for extended wearing comfort
- Una sola contromatrice per tutti i diametri da curvare
A single counter for all diameters to be bent
- Ritorno automatico a molla della matrice
Automatic spring return of the die
- Sistema di riduzione meccanico della forza di curva
Mechanical reduction system of the cornering force
- Matrice ottimizzata per curvare il multistrato
Matrix optimized for bending the multilayer
- In robusta valigetta termoformata PVC
In sturdy thermoformed PVC case

Codice	Ø tubi mm	mm	gr		Barcode
570032P	da 16 a 32	430 X 310	1800	1	8033183590343



508005M MOLLE CURVATUBI MULTISTRATO MULTILAYER BENDING SPRINGS

- In acciaio speciale per molle zincato per maggiore resistenza alla corrosione
Made of special galvanized spring steel for greater corrosion resistance
- Con anello di trascinamento per curvare lontano dall'imboccatura
With drag ring for bending away from the mouthpiece
- Impedisce lo schiacciamento del tubo durante la curva
Prevents crushing of the tube during the bend

Codice	Ø tubi mm	mm	gr		Barcode
508007M	16	1000	1660	10	8033183590282
508009M	20	1000	2270	10	8033183590299
508011M	26	1000	4800	10	8033183590336

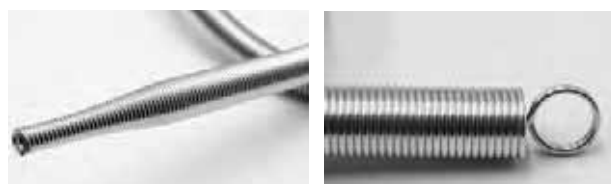

Espansori e cartellatrici

Expanders & folding machines

570055 PINZA AD ESPANSIONE MODULARE MODULAR EXPANSION CLAMP

- Impugnatura ripiegabile ricoperta in gomma
Foldable handle covered in rubber
- Per espandere e calibrare estremità di tubi di rame ricotto spessore max 1mm e tubi di plastica
To expand and calibrate the ends of annealed copper pipes max thickness 1mm and plastic pipes

Codice	Ø tubi mm	mm	gr		Barcode
570055	10 - 22	210	500	1	8033183557025



Fumori
PRO

223501 PINZA ALLARGATUBI MODULAR EXPANSION CLAMP

- Interamente in lamiera con ganasce zigrinate ad apertura parallela
Entirely in sheet metal with knurled parallel opening jaws
- Per espandere tubi in piombo
To expand lead pipes

Codice	Ampiezza (MAX) mm	mm	gr		Barcode
223501	60	240	370	5	8033116548007



570026 APPARECCHIO PER COLLETTI A CRICCO RATCHET COLLAR APPLIANCE

- Per realizzare bordature uniformi e lisce a 45° tramite un'azione di rotolamento del cono per una deformazione graduale del metallo
To create uniform and smooth edges at 45° through an action of rolling of the cone for a gradual deformation of the metal
- Per tubi in rame, ottone e alluminio
For copper, brass and aluminum pipes

Codice	pollici	Ø tubi mm	mm	gr		Barcode
570026	1/4" - 3/4"		11 x 19	1800	1	8033183554611
570026M		6 - 19	11 x 19	1800	1	8033183570826



570040 KIT CARTELLATRICE A CRICCO RATCHET FOLDER KIT

- Cartellatrice per bordature uniformi e lisce a 45°
Flaring machine for uniform and smooth edges at 45°
- Dima serratubo
Pipe clamp template
- Tagliatubi modello tascabile: cod. 507501
Pocket model pipe cutter: cod. 507501
- Sbavatore a raschietto con portalama: cod. 508131
Scraper deburrer with blade holder: cod. 508131

Codice	Ø tubi pollici	mm	gr		Barcode
570040	3/16" - 3/4"	300 x 170	2200	1	8033183596826



570029 APPARECCHIO PER COLLETTI STANDARD PROFESSIONALE
STANDARD COLLAR APPLIANCE PROFESSIONAL MODEL

- ♦ Corpo in acciaio con finitura cromata e barra nichelata lucida
Steel body with chrome finish and bright nickel-plated bar
- ♦ Per realizzare bordature uniformi e lisce a 45° tramite un'azione di rotolamento del cono per una deformazione graduale del metallo
To create uniform and smooth edges at 45° through an action of rolling of the cone for a gradual deformation of the metal
- ♦ Il bloccaggio delle barre impedisce lo slittamento del tubo
The locking of the bars prevents slippage of the tube
- ♦ Per tubi in rame, ottone e alluminio
For copper, brass and aluminum pipes

Codice	Ø tubi pollici	mm	gr		Barcode
570029	3/16" - 5/8"	14 x 17,5	900	1	8033183554642



570027 KIT CARTELLATRICE STANDARD
STANDARD FOLDER KIT

- ♦ Cartellatrice in acciaio con finitura cromata per bordature uniformi e lisce a 45°
Steel flaring machine with chromed finish for edging uniform and smooth at 45°
- ♦ 2 dime serratubo con bloccaggio antislittamento
2 hose clamps with anti-skid locking
- ♦ Punta intercambiabili
Interchangeable tips

Codice	pollici	Ø tubi mm	mm	gr		Barcode
570027	1/8" - 3/4"		32 x 13	1800	1	8033183554734
570028		3 - 19	32 x 13	1800	1	8033183556301



570027R APPARECCHIO PER COLLETTI STANDARD
COLLAR APPLIANCE PROFESSIONAL MODEL

- ♦ Corpo in acciaio con finitura cromata
Steel body with chrome finish
- ♦ Per realizzare bordature uniformi e lisce a 45° tramite un'azione di rotolamento del cono per una deformazione graduale del metallo
To create uniform and smooth edges at 45° through an action of rolling of the cone for a gradual deformation of the metal
- ♦ Dotato di un unico ed universale sistema di bloccaggio autocentrante che agevola l'applicazione su tutti i diametri di tubo
Equipped with a unique and universal self-centering locking system which facilitates application on all pipe diameters
- ♦ Per tubi in rame, ottone e alluminio
For copper, brass and aluminum pipes

Codice	Ø tubi mm	mm	gr		Barcode
570027R	5 - 16	11 x 19	900	1	8033183586667



Pressatrici

Pressing machines

570034P PRESSATRICE MANUALE PER MULTISTRATO PROFESSIONAL MANUAL PRESSING MACHINE

- ♦ In acciaio temperato di alta qualità con braccia a leva che offrono un'espansione ottimale della forza
Made of high quality tempered steel with lever arms offering optimal expansion of force
- ♦ Lo scambio facile degli inserti delle ganasce garantisce un rapido montaggio senza l'utilizzo di prese di pressatura aggiuntive
The easy exchange of the jaw inserts ensures rapid assembly without the use of additional pressing sockets
- ♦ 3 ganasce in dotazione da 16-20-26mm con profilo TH
3 jaws supplied 16-20-26mm with TH profile
- ♦ Chiave combinata 13mm
Combination wrench 13mm

Codice	Ganasce / Jaws mm	mm	kg		Barcode
570034P	16 - 20 - 26	470	3,7	1	8033183596154



570037P PRESSATRICE MANUALE PROFESSIONALE PROFESSIONAL MANUAL PRESSING MACHINE

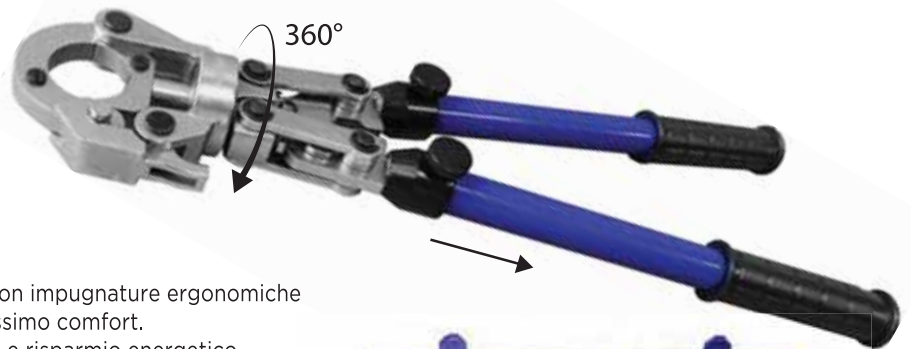

- ♦ In acciaio inossidabile di qualità superior con impugnature ergonomiche gommate antiscivolo progettate per il massimo comfort. Maniglie estensibili per un comodo utilizzo e risparmio energetico
Made of superior quality stainless steel with ergonomic handles non-slip rubber pads designed for maximum comfort. Extendable handles for comfortable use and energy saving
- ♦ Testa rotante a 360° che ne facilita il trasporto e l'uso in aree strette
360° rotating head for easy transport and use in tight areas
- ♦ Testa facile da aprire e permette il cambio delle ganasce senza sforzo
Easy to open head and allows effortless jaw change
- ♦ 4 ganasce in dotazione da 16-20-26-32mm con profilo TH
4 jaws supplied 16-20-26-32mm with TH profile

Codice	Ganasce / Jaws mm	mm	kg		Barcode
570037P	16 - 20 - 26 - 32	570 - 760	6,3	1	8033183596147



Utensili per la saldatura

Welding tools

610201 CANNELLO A GAS PER SALDOBRASATURA GAS TORCH FOR BRAZING

- Corpo in ottone e impugnatura ergonomica resistente al calore con rubinetto per la regolazione del gas
Brass body and heat resistant ergonomic handle with tap for gas regulation
- Temperatura massima 1800 °C
Maximum temperature 1800 °C
- Kit 3 bruciatori con ugelli a getto: 10 - 12 - 14 mm
3 burner kit with jet nozzles: 10 - 14 - 22 mm
- Connettore tubo del gas 3/8"
3/8" gas pipe connector

Codice	Bruciatori / Burners mm	mm	gr		Barcode
610201	Ø 10 L 80	320	400	1	8033183551665
	Ø 12 L 83				
	Ø 14 L 73				



610301 CANNELLO A GAS A FORCHETTA FORK GAS TORCH

- Corpo in ottone e impugnatura ergonomica resistente al calore con leva per comandare l'apertura e la chiusura del gas e rubinetto per la sua regolazione
Brass body and ergonomic heat resistant handle with lever to control the opening and closing of the gas and tap for its regulation
- Becco a forchetta
Fork beak

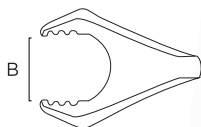

Codice		B mm	mm	gr		Barcode
610301		24	320	350	1	8033183551665
610302		40	320	400	1	8033183557445
610301L	Becco ricambio/ Spare beak	24	200		1	8033183555557
610302L	Becco ricambio/ Spare beak	40	200		1	8033183555564



610401 CANNELLO A GAS + MAZZA RAME GAS TORCH + COPPER HAMMER

- Corpo in ottone e impugnatura ergonomica resistente al calore con rubinetto per la regolazione del gas e piedino d'appoggio
Brass body and heat resistant ergonomic handle with tap for gas regulation and support foot
- Tubo di combustione di Ø 22mm
Combustion tube Ø 22mm
- Mazzetta in rame per saldature stagne da 250 grammi
250 gram copper mallet for watertight soldering
- Temperatura massima di 1100/1200 °C
Maximum temperature of 1100/1200 °C

Codice		mm	gr		Barcode
610401		320	700	1	8033183551634
610401M	Mazza si ricambio / Mallet spare	Asta / Auction 105	250	1	8033183551658



610501 CANNELLO A GAS A BICCHIERE
GLASS GAS TORCH

- Corpo in ottone e impugnatura ergonomica resistente al calore con leva per comandare l'apertura e la chiusura del gas e rubinetto per la sua regolazione
Brass body and heat resistant ergonomic handle with lever to control the opening and closing of the gas and tap for its regulation
- Beccucci bordati per garantire una maggiore resistenza agli urti
Edged nozzles to ensure greater impact resistance

Codice	Bicchiera / Glass mm	mm	gr		Barcode
610501	Ø 45 L 95	385	600	1	8033183551672
610502	Ø 60 L 115	410	650	1	8033183559395

**610701** KIT CANNELLO A GAS A BICCHIERE
GLASS GAS TORCH

- Bruciatore in ottone e impugnatura ergonomica resistente al calore con leva per comandare l'apertura e la chiusura del gas e rubinetto per la sua regolazione
Gas torch for brass brazing and handle ergonomic heat resistant with lever to control the opening and the closing of the gas and tap for its regulation
- Tubo del gas da 10 mt per poter utilizzare il dispositivo di saldatura indipendentemente dalla posizione
10 m gas hose to be able to use the welding device regardless of location
- Riduttore ad alta pressione per bombola GPL
High pressure reducer for LPG cylinder
- 2 chiavi idi servizio e guarnizione
2 service keys and gasket

Codice	Bicchiera / Glass mm	mm	gr		Barcode
610701	Ø 60 L 115	600	2600	1	8033183551627

**610202** SALDATORE A CARTUCCIA GAS
GAS CARTRIDGE WELDER

- Corpo in ABS resistente ai danni meccanici e alle alte temperature e comoda maniglia ignifuga PA6 O 20% + fibra di vetro
ABS body resistant to mechanical damage and high temperatures and comfortable fireproof handle PA6 O 20% + fiberglass
- Accensione a piezo e manopola di regolazione del gas
Piezo ignition and adjustment knob gas dose
- Utilizza cartuccia a gas 190g usa e getta facile da rimuovere
Uses 190g disposable gas cartridge that is easy to remove
- Bruciatore in ottone Ø 20mm
Brass burner Ø 20mm

Codice	Ø mm	mm	gr		Barcode
610202	100	155 X 250	640	5	8033183591890

**610202C** CARTUCCIA GAS BUTANO/PROPANO
BUTANE / PROPANE GAS CARTRIDGE

- Cartuccia usa e getta 190g
Disposable cartridge 190g
- Con attacco a forare con dispositivo di sicurezza Gas Stop
With drilling attachment with Gas Stop safety device

Codice	Ø mm	mm	gr		Barcode
610202C	95	80	190	10	8033183591906



610203 PISTOLA SALDATORE A CARTUCCIA GAS GAS CARTRIDGE WELDING GUN

- Corpo in plastica ignifuga PA6 0 20% + fibra di vetro
Fireproof plastic body PA6 0 20% + glass fiber
- Accensione a piezo e manopola di regolazione del gas
Piezo ignition and adjustment knob gas dose
- Utilizza bombola con valvola 400ml usa e getta facile da rimuovere
It uses 400ml disposable gas cartridge that is easy to remove
- Bruciatore in ottone Ø 20mm
Brass burner Ø 20mm

Codice	mm	gr		Barcode
610203	150 X 250	300	5	8033183591913



610204 BRUCIATORE PER BRASATURA BRAZING BURNER

- In ottone di alta qualità, anti-ruggine e resistente al calore
Made of high quality brass, anti-rust and heat resistant
- Regolazione dell'alimentazione dell'aria
Adjusting the air supply
- Regolazione fiamma tramite valvola di regolazione integrata
Flame regulation via integrated regulation valve

Codice	mm	gr		Barcode
610204	120	220	10	8033183591920



610204C CARTUCCIA GAS 400ML 400ML GAS CARTRIDGE

- Attacco filetto 7/16"
7/16" thread connection
- Sistema upside-down
Upside-down system

Codice	Ø mm	mm	gr		Barcode
610204C	63	170	400	10	8033183591937
610205	Set cartuccia 400ml + bruciatore / 400ml + cartridge set burner	200	620	10	8033183592071



610901 POLIFUSORE TERMOPIASTRA PER SALDATURA POLIFUSER THERMOPLAY FOR WELDING

- Saldatura testa a testa di tubi in materiale plastico PE, PP, PVC e PVDF
Butt welding of plastic pipes PE, PP, PVC and PVDF
- Con supporto per appoggiare il polifusore
Support to support the polywelder
- Alimentazione 230V - 50/60 Hz
Power supply 230V - 50/60 Hz

Codice	Temperatura / Temperature	Capacità / Capacity Ø mm	gr		Barcode
610901	180° - 300°	120	2000	1	8033183571045
610902	180° - 300°	190	2400	1	8033183560315



610805 KIT POLIFUSORE MANUALE
MANUAL POLIFUSER KIT

- Polifusore per tubi in plastica con termostato per la regolazione della temperatura da 50 a 320° con una potenza di 1500W
Polywelder for plastic pipes with thermostat for regulation of the temperature from 50 to 320 ° with a power of 1500W
- Supporto per appoggiare il polifusore
Support for placement of the polywelder
- 3 matrici Ø 20, 25, 32mm
3 dies Ø 20, 25, 32mm

Codice	Matrici / Dies Ø mm	mm	gr		Barcode
610805	20 - 25 - 32	390 x 97	3600	1	8033183555892

**610816** MATRICI PER POLIFUSORE
DIES FOR POLYWELDER

Codice	Matrici / Dies Ø mm		Barcode
610816	16	1	8033183570994
610820	20	1	8033183555915
610825	25	1	8033183571007
610832	32	1	8033183571014
610840	40	1	8033183555908
610850	50	1	8033183571021
610863	63	1	8033183571038

**570020** MORSA DA BANCO RIBALTABILE
TILTING BENCH VICE

- Il corpo ed il telaio sono in ghisa ad alta resistenza
The body and the frame are in high resistance cast iron
- Ganasce a "V" in lega di acciaio
Steel alloy "V" jaws
- 5 Fori ausiliari per la curvatura di tubi
5 Auxiliary holes for bending pipes

Codice	pollici	Ø tubi mm	mm	gr		Barcode
570020	1/8" - 2"	10 - 60	220 x 190	4100	1	8033183555205
570021	1/8" - 3"	10 - 89	320 x 270	8000	1	8033183556806
570020R	Ganasca di ricambio / Spare jaw			600	2	8033183560827
570021R	Ganasca di ricambio / Spare jaw			900	2	8033183570819

**507203** BANCO PER IDRAULICI CON MORSA RIBALTABILE
BENCH FOR PLUMBERS WITH FOLDING VICE

- Morsa ribaltabile a sgancio rapido per una estrazione rapida dei tubi lunghi
Quick release folding vice for quick extraction of long tubes
- Dotato di ampio campo di lavoro che va 1/4" fino a 3"
Equipped with a wide working range ranging from 1/4" up to 3"
- 5 Fori ausiliari per la curvatura di tubi
5 Auxiliary holes for bending pipes

Codice	pollici	Ø tubi mm	mm	gr		Barcode
507203	1/8" - 3"	6 - 80	700	18000	1	8033183554673



Utensili per la manutenzione e riparazione dei tubi

Maintenance and repair tools of pipes

Disostruenti

Unclogging

570025V POMPA VERTICALE PER COLLAUDO IMPIANTI VERTICAL PUMP FOR SYSTEM TESTING

- Componenti principali in ottone e acciaio INOX resistenti alla corrosione
Main components in corrosion resistant brass and stainless steel
- Manometro di qualità per una maggiore sicurezza nel collaudo
Quality pressure gauge for greater safety in testing
- Serbatoio in acciaio rinforzato e verniciato con capacità di 12lt
Reinforced and painted steel tank with a capacity of 12lt
- Pressione massima 60 ATM
Maximum pressure 60 ATM
- Tubo ad alta pressione con attacco da 1/2"
High pressure hose with 1/2" connection

Codice		kg		Barcode
570025V	500 x 190x 140	8,5	1	8033183559067



570035 POMPA DISINCROSTANTE CON INVERSIONE FLUSSO DESCALING PUMP WITH REVERSE FLOW

- È costruita in materiale antiacido
Antacid material body
- Motore elettrico monofase 230V - 50HZ, assemblato su un coperchio a chiusura svitabile e asportabile, per consentire una manutenzione estremamente semplice
Single-phase electric motor 230V - 50HZ, assembled on a closing lid unscrewable and removable, to allow extremely simple maintenance
- Dotata di valvola con flusso invertitore che permette al liquido disincrostante di agire alternativamente ai due capi del circuito
Equipped with valve with reversing flow that allows the descaling liquid to act alternatively at the two ends of the circuit
- Portata massima 30 l/min
Maximum flow 30 l/min
- Serbatoio con capacità di 18lt
Tank with a capacity of 18lt

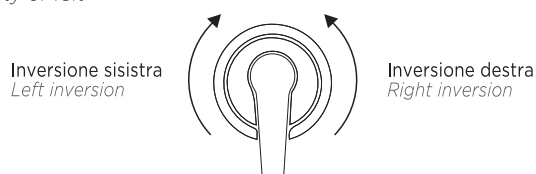

Codice	mm	kg		Barcode
570035	500 x 360x 360	9,5	1	8033183573285
570035D	Disincrostante / Descaler	10	1	8033183590404





570031 POMPA DISOSTRUENTE MANUALE MANUAL UNCLOGGING VERTICAL PUMP

- ◆ Impugnatura a tampone rigida ed ergonomica
Rigid ergonomic pad handle
- ◆ Manometro di qualità per una maggiore sicurezza nel collaudo fino a 12 BAR
Quality pressure gauge for greater safety in testing up to 12 bar
- ◆ Fornita di tubo aria compressa in gomma con cono con nuovo sistema di espulsione dello stesso tramite leva, 2 accessori protettivi e tubo spiralato per caricare i vasi d'espansione
Equipped with compressed air hose in rubber with cone with new system expulsion by means of a lever, 2 protective accessories and spiral tube to load the expansion vessels
- ◆ Portata massima 125cc/ciclo
Maximum flow 125cc / cycle
- ◆ Pressione massima fino a 8 BAR
Maximum pressure up to 8 BAR
- ◆ Serbatoio in acciaio rinforzato e verniciato con capacità di 3lt
Reinforced and painted steel tank with a capacity of 3lt



Codice		∅ mm		Barcode
570031	Per tubi 580 x 170mm / For tubes 580 x 170mm		1	8033183555229
1	Tampone largo / Wide pad	170	1	
2	Tampone medio / Medium pad	100	1	
3	Tampone piccolo / Small pad	65	1	
4	Spirale / Spiral		1	
5	Raccordo / Fitting		1	
6	Terminale / Terminal		1	
7	Sager / Sager		1	
8-10	O-ring / O-ring		1	
9	Raccordo / Fitting		1	
11	Boccola pressione / Pressure bushing		1	
12	Tubo / Tube		1	
13	Fascetta / Cable tie		1	
14	Manometro / Gauge		1	
15	Rubinetto scorrevole / Sliding tap		1	
16	Tappo sup. / Top cap		1	
17	O-ring / O-ring		1	
18	O-ring / O-ring		1	
19	Cilindro / Cylinder		1	
20	O-ring / O-ring		1	
21	Raccordo valvola / Valve fitting		1	
22	Sfera / Ball		1	
23	Molla / Spring		1	
24	Tappo inf. / Bottom cap		1	
25	Impugnatura / Handle		1	
27	Stelo / Stem		1	
28	Guarnizione / Gasket		1	
29	Pistone / Piston		1	
30	Oring / Oring		1	
35	Pompa aria / Air pump		1	
36	Tubo + valvola espulsione / Pipe+ ejection valve		1	

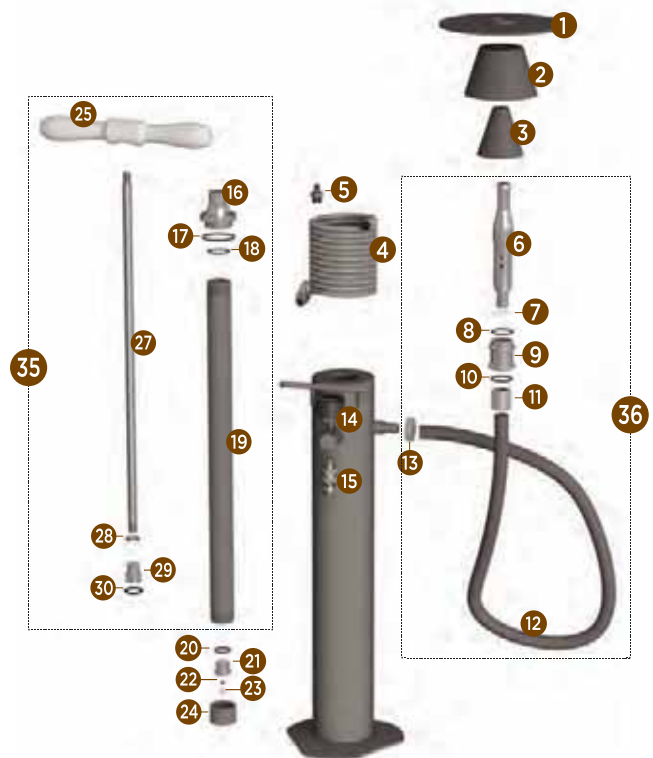

508301 STURALAVANDINI MANUALE
MANUAL PLUNGER SPRINGS

- Corpo in plastica resistente
Durable plastic body
- Robusta molla a spirale che consente di pulire persino gli ingorghi più ostinati
Sturdy spiral spring that allows to clean even persistent clog



Codice	mt	gr		Barcode
508301	4,6	1000	1	8033116548069

508302P STURALAVANDINI MANUALE ATTACCO PER TRAPANO
MANUAL PLUNGER SPRINGS WITH DRILL ATTACHMENT

- Robusta molla a spirale che consente di pulire persino gli ingorghi più ostinati
Sturdy spiral spring that allows to clean even persistent clog
- Impugnatura a pistola ergonomica e ruotabile per un utilizzo confortevole
Ergonomic and rotatable pistol grip for comfortable use
- Applicabile su un qualsiasi trapano con mandrino a velocità variabile per una maggiore potenza
Applicable on any drill with variable speed spindle for more power



Codice	mt	gr		Barcode
508302P	7,5	1500	1	8033183581310

508201 MOLLE STURALAVANDINI CON SPIRALE
PLUNGER SPRINGS WITH SPIRAL

- Cavo a spirale a molla in acciaio temprato zincato
Spiral spring cable in hardened galvanized steel
- Maniglia in pvc per una maggior ergonomia durante l' utilizzo
PVC handle for greater ergonomics during use

Codice	Molla / Spring Ø mm	mt	gr		Barcode
508201	7,0	1,5	300	5	8033116548014
508202	7,0	2,5	400	5	8033116548021
508203	7,0	3,5	550	5	8033116548038
508204	7,0	5,0	650	5	8033116548045
508205	7,0	7,5	850	5	8033116548052

508401 MOLLE STURAFOGNE CON SPIRALE
DRAINAGE SPRINGS WITH SPIRAL

- Cavo a spirale a molla in acciaio temprato zincato
Spiral spring cable in hardened galvanized steel
- Maniglia in pvc per una maggior ergonomia durante l'utilizzo
PVC handle for greater ergonomics during use



Codice	Molla / Spring Ø mm	mt	gr		Barcode
508401	9,0	3,0	300	5	8033116548083
508402	9,0	5,0	1300	5	8033116548090
508403	9,0	7,0	1800	5	8033116548106
508404	9,0	10,0	2500	5	8033116548113

508201P STURALAVANDINI A MOLLA "FLEXY"
"FLEXY" PLUNGER SPRINGS

- In acciaio rivestito in plastica
Plastic body steel coated
- Manovella di manovra per un lavoro efficace sia sugli scarichi diretti che su quelli dotati di sifone
Maneuvering handle for effective work both on direct drains and siphon drains
- Robusta molla a spirale interamente in acciaio inossidabile e al 100% flessibile ed inalterabile
Sturdy spiral spring entirely in stainless steel and 100% flexible and unalterable

Codice	mt	gr		Barcode
508201P	1,5	300	5	8033183596369
508202P	2,5	400	5	8033183596376
508203P	3,5	550	5	8033183596055
508204P	5,0	650	5	8033183596062
508205P	7,5	850	5	8033183596239
508206P	10,0	1000	5	8033183596383

**508400P** STURAFOGNE A MOLLA "SUPERFLEXY"
"SUPERFLEXY" DRAINAGE SPRINGS

- In acciaio rivestito in plastica
Plastic body steel coated
- Manovella di manovra per un lavoro efficace sia sugli scarichi diretti che su quelli dotati di sifone
Maneuvering handle for effective work both on direct drains and siphon drains
- Robusta molla a spirale interamente in acciaio inossidabile e al 100% flessibile ed inalterabile
Sturdy spiral spring entirely in stainless steel and 100% flexible and unalterable

Codice	mt	gr		Barcode
508400P	1,5	300	5	8033183596079
508401P	2,5	400	5	8033183596086
508402P	3,5	550	5	8033183596093
508403P	5,0	650	5	8033183596338
508404P	7,0	850	5	8033183596345
508405P	10,0	1000	5	8033183596208
508406P	15,0	1300	5	8033183596161

**508407P** STURAFOGNE A GANCIO "SUPERFLEXY BIS"
"SUPERFLEXY BIS" HOOK-UP DRAINAGE SPRINGS

- In acciaio rivestito in plastica
Plastic body steel coated
- Manovella di manovra per un lavoro efficace sia sugli scarichi diretti che su quelli dotati di sifone
Maneuvering handle for effective work both on direct drains and siphon drains
- Fabricato con una molla a spirale alla quale è fissato un solido gancio cromato
Manufactured with a spiral spring to which a solid chrome hook is attached

Codice	mt	gr		Barcode
508407P	3,0	300	5	8033183595539
508408P	5,0	400	5	8033183595546
508409P	7,5	550	5	8033183595553
508410P	10,0	650	5	8033183596352
508411P	15,0	850	5	8033183595560



570042 STURASCARICHI AD ARIA COMPRESSA
 COMPRESSED AIR RELEASE PUMP DRAINER

- Corpo a pistola in ABS con testa in gomma di alta qualità.
 Il serbatoio dell'aria ad alta pressione è rinforzato e dotato di una valvola dell'aria di sicurezza
ABS pistol body with high quality rubber head; the air reservoir high pressure is reinforced and equipped with a safety air valve
- 4 adattatori permettono di lavorare su differenti misure:
4 adapters allow you to work on different sizes:

2 x inserti per scarichi lavelli
 2 x sink drain inserts

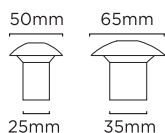

1 x inserto per WC
 1 x toilet insert

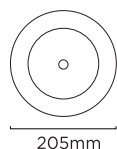

1 x inserto per scarichi vasca
 1 x insert for tub drains

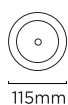

Codice	mm	gr		Barcode
570042	280 x 275	1000	3	8033183596840

570061 STURASCARICHI A POMPA CON VENTOSA
 PUMP DRAINER WITH SUCTION CUP

- Corpo in plastica con stantuffo ad apertura automatica per un'aspirazione extra
Plastic body with self-opening plunger for an extra suction
- Ventosa in gomma
Rubber suction cup

Codice	mm	gr		Barcode
570061	380	260	6	8033183596895



Chiavi per tubi

Keys for pipes

► Gamma chiavi di manovra pag. 100 Wrench range pag. 100

560003 CHIAVI PER LAVABI TELESCOPICA KEYS FOR TELESCOPIC WASHBASINS

- ♦ Corpo telescopico in acciaio cromato con ganascho mobile forgiato
Chromed steel telescopic body with forged movable jaw
- ♦ Dispositivo di serraggio che mantiene la testa bloccata in qualsiasi posizione fino ad un angolazione massima di 90°
Clamping device that keeps the head locked in any position up to a maximum angle of 90°

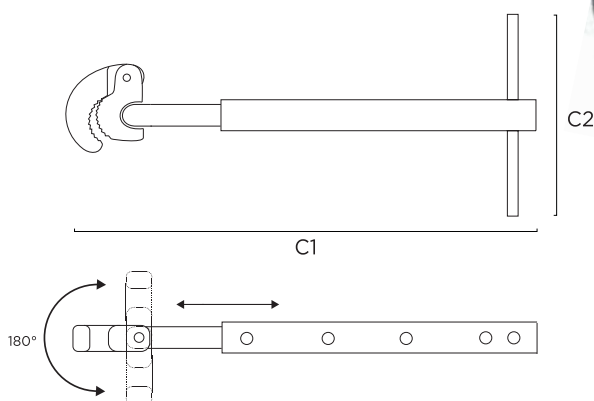

Codice	Capacità ganaschia / Jaw capacity mm	C1 mm	C2 mm	gr	📦	Barcode
560003	10 - 32	270 - 430	120	800	5	8033183552136

560023 CHIAVI PER LAVABI STANDARD STANDARD WASHBASINS KEYS

- ♦ Corpo in acciaio cromato con ganascho mobile forgiato
Chrome steel body with forged movable jaw
- ♦ Ganasce reversibili regolabili a molla che mantengono una presa automatica sui raccordi per tubi
Adjustable reversible spring jaws that maintain a grip automatic on pipe fittings

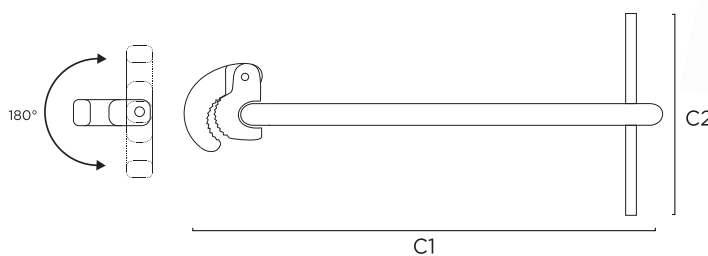

Codice	Capacità ganaschia / Jaw capacity mm	C1 mm	C2 mm	gr	📦	Barcode
560023	10 - 32	288	120	500	5	8033183551757

577580 KIT CHIAVE ESAGONALE PER LAVABI
 HEXAGONAL KEY KIT FOR WASHBASINS

- Struttura tubolare verniciata rossa a ingombro ridotto ed estremità cava per evitare l'interferenza delle aste filettate
Red painted tubular structure with reduced overall dimensions and hollow end to avoid interference of the threaded rod
- Fornita con 6 inserti bussole esagonali: 9 - 10 - 11 - 12 - 14 - 17mm
Supplied with 6 hexagonal socket inserts: 9 - 10 - 11 - 12 - 14 - 17mm

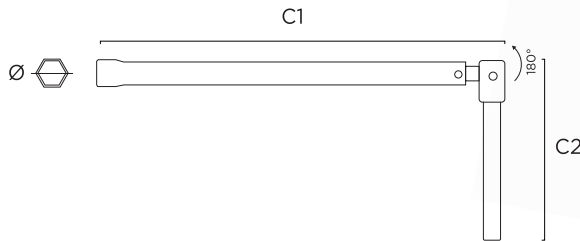

Codice	Ø mm	C1 mm	C2 mm	gr	📦	Barcode
577580	13,0	260	120	250	1	8033183568212



577581 KIT CHIAVE ESAGONALE PER LAVABI + TESTA
 HEXAGONAL KEY KIT FOR WASHBASINS + HEAD

- Struttura tubolare verniciata rossa a ingombro ridotto ed estremità cava per evitare l'interferenza delle aste filettate
Red painted tubular structure with reduced overall dimensions and hollow end to avoid interference of the threaded rod
- Testa nera snodata regolabile fino al Ø 32mm
Adjustable black jointed head up to Ø 32mm
- Fornita con 6 inserti bussole esagonali: 9 - 10 - 11 - 12 - 14 - 17mm
Supplied with 6 hexagonal socket inserts: 9 - 10 - 11 - 12 - 14 - 17mm

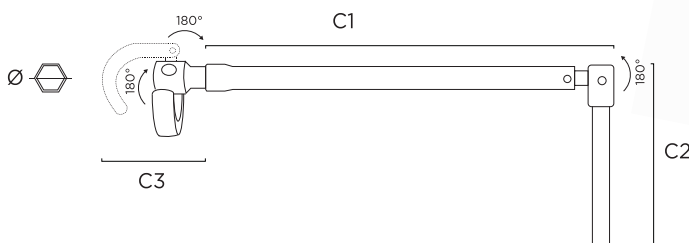

Codice	Ø mm	C1 mm	C2 mm	C3 mm	gr	📦	Barcode
577581	13,0	260	120		250	1	8033183570949
577582	Testa singola / Single head		75	160	1		8033183570956



560004 CHIAVE A CRICCHETTO PER RADIATORI
 RATCHET WRENCH FOR RADIATORS

- Corpo in acciaio speciale e comoda impugnatura in gomma
Special steel body and comfortable rubber handle
- Attacco per cricco quadro femmina da 1/2"
1/2" female square ratchet connection
- Fornita con codolo a scala graduata da: Ø 3/8" - 1/2" - 3/4" - 1"
Supplied with graduated scale shank from: Ø 3/8" - 1/2" - 3/4" - 1"

1/2"



Codice	mm	mm	gr	📦	Barcode	
560004	1/2"	240	600	1	8033183551771	
560004C	Codolo singolo / Single shank		90	100	12	8033183555151



560014 CHIAVE PER ACCOPPIAMENTO RADIATORI
KEY FOR COUPLING RADIATORS

- Corpo in acciaio forgiato dal pieno per una maggior sicurezza
Forged from solid steel body for greater safety
- Per accoppiare o scoppiare radiatori in alluminio o ghisa da Ø 1" - 1¼"
To couple or explode radiators in aluminum or cast iron from Ø 1" - 1¼"

Codice	Attacco / Connection	Ø mm	mm	gr	Barcode
560014	1"	18	500	900	5 8033183553485
560015	1"	18	750	1350	5 8033183553744
560016	1"	18	1000	1600	5 8033183554741
560017	1¼"	25	500	1300	5 8033183554260
560018	1¼"	25	750	2100	5 8033183554277
560020	Leva attacco femmina / Female connection lever	25	500	1400	5 8033183553478

**570063** CHIAVE PER MONTAGGIO TAPPI RADIATORI
KEY FOR MOUNTING THE RADIATOR CAPS

- Interamente in plastica antigraffio
Entirely in scratch-resistant plastic
- Indicata per diametri esagonali con misura: Ø 17 - 22 - 25 28 - 32mm
Suitable for hexagonal diameters with measure: Ø 17 - 22 - 25 28 - 32mm

Codice	mm	gr	Barcode
570063	265	140	10 8033183596949

**570033** CHIAVE UNIVERSALE PER PILETTA
UNIVERSAL WRENCH FOR DRAIN

- 2 perni a molla in acciaio resistente che autoregolano la misura da utilizzare
2 self-adjusting heavy duty steel spring pins the measure to use
- Manico scorrevole che consente l'utilizzo dell'attrezzo sia dall'alto che dal basso
Sliding handle that allows the use of the tool both from above and from low
- Per l'installazione e la sostituzione delle pilette dei lavabi e bidet da 1" e 1¼"
For the installation and replacement of 1" and 1¼" washbasin and bidet drains

Codice	mm	gr	Barcode	
570033	In alluminio / Aluminum body	160	300	2 8033183555243
570033E	In plastica / Plastic body	160	300	2 8033183833181

**560005** DIMA REGOLABILE CON BOLLA
ADJUSTABLE TEMPLATE WITH BUBBLE

- Dima con doppia livella in alluminio
Template with double level in aluminum
- Interassi: 90 - 110 - 120 - 140 - 150 - 160 - 180 - 200 - 220mm
Center distances: 90 - 110 - 120 - 140 - 150 - 160 - 180 - 200 - 220mm

Codice	Perni / Pins Ø mm	mm	gr	Barcode
560005	1/2"	260	800	2 8033183551764



Fascette stringitubo

Hose clamp

274002 FASCETTE STRINGITUBO IN ACCIAIO INOX STAINLESS STEEL HOSE CLAMPS

- In acciaio inossidabile AISI 430 resistente alla corrosione e alla ruggine
Made with stainless steel AISI 430 resistant to corrosion and rust
- Bordi arrotondati e banda piena da 9mm
Rounded edges and full 9mm band

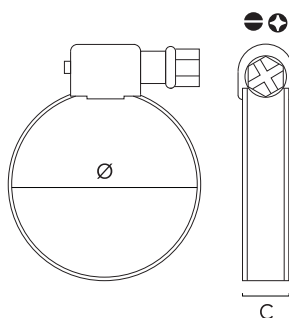

Codice	Ø mm	C mm	gr	📦	Barcode
274002	10 - 17	9	1300	100	8033183553362
274003	12 - 22	9	1400	100	8033183552884
274004	16 - 27	9	1450	100	8033183552211
274005	20 - 32	9	1500	100	8033183552891
274006	24 - 45	9	1580	100	8033183553669
274007	32 - 50	9	1630	100	8033183553676

Codice	Ø mm	C mm	gr	📦	Barcode
274008	40 - 60	9	1740	100	8033183554925
274009	60 - 80	9	950	50	8033183553348
274010	80 - 100	9	1050	50	8033183553355
274011	100 - 120	9	767	30	8033183553376
274012	120 - 140	9	801	30	8033183553331

274020 KIT FASCETTE STRINGITUBO IN ACCIAIO INOX STAINLESS STEEL HOSE CLAMPS

- Kit per realizzare fascette stringitubo in acciaio AISI 304 resistente alla corrosione e alla ruggine
Kit to make hose clamps in resistant AISI 304 steel corrosion and rust
- Bordi arrotondati e banda piena da 9mm
Rounded edges and full 9mm band
- Includi 8 cremagliere con relativi adattatori
8 racks with relative adapters included

Codice	mt x mm	gr	📦	Barcode
274020	3 x 9	2640	10	8033183552785



Set di utensili per idraulici

Tool set for plumbers

► Per specifiche sui portautensili vedi pag. 286 "BORSE E CONTENITORI"
For specifics on tool holders see p. 286 "BAGS AND CONTAINERS"

100425PP ASSORTIMENTO 9 UTENSILI PER IDRAULICI ASSORTMENT OF 9 TOOLS FOR HYDRAULICS

- ◆ Pinze regolabili: cod. 167351
Adjustable pliers: cod. 167351
- ◆ **Giratubi:** Giratubo universale svedese: cod. 501003
Tagliatubo a vite: cod. 507601
Tagliatubo tascabile: cod. 507501
Pipe wrench: Swedish universal pipe wrench: cod. 501003
Screw pipe cutter: cod. 507601 - Pocket cutter: cod. 507501
- ◆ Cesoia per tubi a cremagliera: cod. 231410
Rack pipe shears: cod. 231410
- ◆ **Chiavi:** Chiavi per raccordi tubi: cod. 317008; 317009
Chiavi per pilette: cod. 570033
Serie chiavi combinate: cod. 336001P
Keys: Keys for pipe fittings: cod. 317008; 317009
Keys for waste: cod. 570033 - Comb. wrench series: cod. 336001P
- ◆ Forbici per elettricisti: cod. 230836
Electrician's scissors: cod. 230836

Borsa in tessuto tecnico: cod. 100425
Technical fabric bag: cod. 100425



Codice		Barcode
100425PP	1	8033183594129

100429PP ASSORTIMENTO 13 UTENSILI PER IDRAULICI ASSORTMENT OF 13 TOOLS FOR HYDRAULICS

- ◆ Pinze regolabili: cod. 167351
Adjustable pliers: cod. 167351;
- ◆ **Giratubi:** Giratubo universale svedese: cod. 501002
Tagliatubo a vite: cod. 507601
Tagliatubo tascabile: cod. 507501
Pipe wrench: Swedish universal pipe wrench: cod. 501002
Screw pipe cutter: cod. 507601 - Pocket cutter: cod. 507501
- ◆ **Chiavi:** Chiavi per pilette: cod. 570033
Serie chiavi combinate: cod. 336001P
Keys for waste: cod. 570033 - Comb. wrench series: cod. 336001P
- ◆ Forbici per elettricisti: cod. 230836
Electrician's scissors: cod. 230836
- ◆ Martello per meccanici: cod. 148103
Mechanics hammer: cod. 148103
- ◆ Flessometro 5m x 19 mm: cod. 601007
5m x 19 mm measuring tape: cod. 601007
- ◆ Seghetto leggero per ferro + lame ricambio per ferro: cod. 181501; 181502
Lightweight hacksaw for iron + spare blades for iron: cod. 181501; 181502
- ◆ Cutter in ABS + lama ricambio: cod. 232101 + 232101A
ABS cutter + spare blade: cod. 232101 + 232101A

Zaino trolley multifunzione: cod. 100429
Multifunction trolley backpack: cod. 100429



Codice		Barcode
100429PP	1	8033183594136

100722PP ASSORTIMENTO 18 UTENSILI PER IDRAULICI ASSORTMENT OF 18 TOOLS FOR HYDRAULICS



- Pinze regolabili: cod. 167351; 167352
Adjustable pliers: cod. 167351; 167352
- **Giratubi:** Giratubo universale svedese: cod. 501003
Tagliatubo a vite: cod. 507601
Tagliatubo tascabile: cod. 507501
Pipe wrench: Swedish universal pipe wrench: cod. 501003
Screw pipe cutter: cod. 507601
Pocket cutter: cod. 507501
- Cesoa per tubi a cremagliera: cod. 231410
Rack pipe shears: cod. 231410
- **Chiavi:** Chiavi per raccordi tubi: cod. 317007; 317008; 317009
Chiave per pilette: cod. 570033
Serie chiavi combinate: cod. 336001P
Keys: Keys for pipe fittings: cod. 317007; 317008; 317009
Key for waste: cod. 570033
Combination wrench series: cod. 336001P
- Forbici per elettricisti: cod. 230836
Electrician's scissors: cod. 230836
- Serie giraviti per meccanici: cod. 104203 
Mechanics screwdriver series: cod. 104203
- Martello per meccanici: cod. 148105
Mechanics hammer: cod. 148105
- Flessometro 5m x 19 mm: cod. 601007
5m x 19 mm measuring tape: cod. 601007
- Sbavatore universale per tubi: cod. 508125
Universal deburrer for pipes: cod. 508125
- Seghetto leggero per ferro + lame ricambio per ferro: cod. 181501 + 181502
Lightweight hacksaw for iron + spare blades for iron: cod. 181501 + 181502



Valigia in alluminio: cod. 100722
Aluminum case: cod. 100722

Codice		Barcode
100725PP	1	8033183594143

100455 SET 4 UTENSILI PER IDRAULICI 4 TOOLS SET FOR HYDRAULICS

- Pinza regolabile 175mm: cod. 167200
Adjustable pliers 175mm: cod. 167200
- Giraviti a intaglio: cod. 2454N01 
Slotted screwdrivers: cod. 2454N01
- Giraviti a croce PH: cod. 2452N01 
PH cross screwdrivers: cod. 2452N01
- Forbici per elettricisti: cod. 230835
Professional insulated scissors: cod. 230845

Trousse in cordura (nera) : cod. 100450V
Cordura bag: cod. 100450V

Trousse in nylon (rossa) : cod. 100470V
Nylon bag: cod. 100456V



Codice		gr		Barcode
100455	Rossa / Red 100450V	350	5	8033183553980
100475	Nera / Black 100470V	400	5	8033183553997

PERFETTO

BILANCIAMENTO PER UNA RESA MAGGIORE

PERFECT BALANCE FOR GREATER YIELD



08



LINEA PRO
PRO LINE



TESTA MAGNETICA
MAGNETIC HEAD

197 Martelli e mazzette
Hammers and mallets

08

Martelli e mazzette Hammers and mallets

1 Testa in acciaio C45 temprato a induzione con verniciatura a polvere epossidica.
Head in induction hardened C45 steel with epoxy powder coating.

2 Manico in bi-componente antiscivolo con anima interna in fibra di vetro.
La rigidità della fibra, associata alla flessibilità del polipropilene, permettono un risultato di alta qualità.
*Non-slip bi-component handle with internal fiberglass core.
The stiffness of the fiber, associated with the flexibility of the polypropylene, allow a high quality result.*



3 Manico in frassino che oltre ad essere molto robusto ha il pregio di conservare nel tempo la sua forma.
Ash handle which in addition to being very sturdy has the advantage of preserving its shape over time.



148102 MARTELLO IN FIBRA PER MECCANICI FIBER MALLETT FOR MECHANICS

- Testa quadra piana e penna simmetrica
Square flat head and symmetrical pen
- Modello tedesco
German model

Codice	Peso testa / Head weight gr	mm	gr		Barcode
148102	200	285	300	6	8033116531856
148103	300	275	500	6	8033116531009
148104	400	275	600	6	8033116531863
148105	500	305	650	6	8033116531016
148106	600	310	800	6	8033116548205
148107	800	360	1100	4	8033116548212
148108	1000	390	1300	4	8033116548229



148001 MARTELLINO IN LEGNO PER MECCANICI WOODEN MALLET FOR MECHANICS

- Testa quadra piana e penna simmetrica
Square flat head and symmetrical pen
- Modello tedesco
German model

Codice	Peso testa / Head weight gr	mm	gr		Barcode
148001	100	265	180	6	8033116530965
148002	200	280	255	6	8033116544351
148003	300	300	410	6	8033116530972
148005	500	320	600	6	8033116530989
148006	600	330	700	6	8033116544375
148007	800	350	960	4	8033116544382
148008	1000	360	1150	4	8033116544399
148009	1500	380	1650	4	8033116548182
148010	2000	400	2150	4	8033116548199



148905 MARTELLINO IN FIBRA PER CARPENTIERI FIBER MALLET FOR CARPENTERS

- Testa con magnete fermachiodo
Head with nail clip magnet
- Con salvamanico
With protective handle

Codice	Peso testa / Head weight gr	mm	gr		Barcode
148905	250	450	600	6	8033116548281
148903	300	450	700	6	8033116531375
148904	400	450	800	6	8033116531382
148903M	Manico ricambio / Replacement handle	450	200	12	8033183561497



148805 MARTELLINO IN LEGNO PER CARPENTIERI WOODEN MALLET FOR CARPENTERS

- Testa con magnete fermachiodo
Head with nail clip magnet
- Con salvamanico
With protective handle

Codice	Peso testa / Head weight gr	mm	gr		Barcode
148805	250	450	400	6	8033116548250
148803	300	450	500	6	8033116548267
148804	400	450	550	6	8033116548274
148803M	Manico ricambio / Replacement handle	450	172	25	8033183568670



148907 MARTELLINO IN FIBRA PER CARPENTIERI FIBER MALLET FOR CARPENTERS

- Tipo malepeggio
Malepeggio type

Codice	Peso testa / Head weight gr	mm	gr		Barcode
148907	400	405	600	4	8033183552747
148907M	Manico ricambio / Replacement handle	400	200	10	8033183568250



149301 MAZZETTA IN FIBRA PER MURATORI
FIBER MALLETT FOR MASONRY

- ♦ Doppia testa quadra piana
Double flat square head

Codice	Peso testa / Head weight gr	mm	gr		Barcode
149301	800	260	1000	4	8033116532693
149302	1000	270	1200	4	8033116544405
149303	1250	285	1400	4	8033116544412
149304	1500	285	1550	4	8033116548359
149305	2000	300	2200	2	8033116547055
149301M	Manico ricambio / Replacement handle	270	250	12	8033183560513



149001 MAZZETTA IN LEGNO PER MURATORI
WOODEN MALLETT FOR MASONRY

- ♦ Doppia testa quadra piana
Double flat square head
- ♦ Impugnatura sagomata ed ergonomica
Contoured and ergonomic handle

Codice	Peso testa / Head weight gr	mm	gr		Barcode
149001	800	260	970	4	8033116548298
149002	1000	260	1150	4	8033116548304
149003	1250	260	1390	4	8033116548311
149004	1500	280	1690	2	8033116548328
149005	2000	300	2250	2	8033116548335



149532 ESPOSITORE 30 MARTELLI / MAZZETTE
EXHIBITOR 30 HAMMERS / HAMMERS

Codice			Barcode
149532	8 x 148103	1	8033116548342
	6 x 148104 - 148105 - 148106		
	2 x 148904		
	2 x 149301 - 149302 - 149303 - 149304		



150000 MAZZUOLA IN LEGNO CON TASSELLI
WOODEN MALLETT WITH DOWELS

- ♦ Tasselli intercambiabili in materiale plastico (poliuretano)
Interchangeable plastic plugs (polyurethane)

Codice		Ø mm	mm	gr		Barcode
150000		22	260	135	6	8033116548366
150001		28	280	245	6	8033116548373
150002		35	310	400	4	8033116548380
150003		42	310	625	4	8033116548397
150005		50	320	905	2	8033116548403
150006		60	380	1450	2	8033116548410
150100	Tasselli ric. / Repl. dowels	22		6	4	8033116548427
150101	Tasselli ric. / Repl. dowels	28		12	4	8033116548434
150102	Tasselli ric. / Repl. dowels	35		21	4	8033116548441
150103	Tasselli ric. / Repl. dowels	42		42	4	8033116548458
150105	Tasselli ric. / Repl. dowels	50		70	2	8033116548465
150106	Tasselli ric. / Repl. dowels	60		83	2	8033116548472



150202 MAZZUOLA ANTIRIMBALZO CON TASSELLI NON-REBOUND Mallet WITH DOWELS

- Tasselli intercambiabili in materiale plastico (nylon PA12)
Interchangeable plastic plugs (nylon PA12)
- Manico in legno
Wooden handle

Codice		Ø mm	mm	gr	📦	Barcode
150202		30	325	470	6	8033116548489
150203		35	330	550	6	8033116548496
150204		40	335	650	4	8033116548502
150205		45	340	790	4	8033116548519
150206		50	345	1035	2	8033116548526
150207		60	355	1360	2	8033116548533
150302	Tasselli ric. / Repl. dowels	30		12	4	8033116548540
150303	Tasselli ric. / Repl. dowels	35		18	4	8033116548557
150304	Tasselli ric. / Repl. dowels	40		22	2	8033116548564
150305	Tasselli ric. / Repl. dowels	45		34	2	8033116548571
150306	Tasselli ric. / Repl. dowels	50		44	2	8033116548588
150307	Tasselli ric. / Repl. dowels	60		67	2	8033116548595



150401 MAZZUOLA ANTIRIMBALZO CON TASSELLI NON-REBOUND Mallet WITH DOWELS

- Tasselli intercambiabili in materiale plastico (nylon PA12)
Interchangeable plastic plugs (nylon PA12)
- Manico in ferro con impugnatura rivestita in morbida gomma
Iron handle with soft rubber coated grip

Codice		Ø mm	mm	gr	📦	Barcode
150401		35	310	574	4	8033183559609
150402		40	315	880	4	8033183560339
150403		50	325	1320	2	8033183560346
150404		60	335	1750	2	8033183561824
150401R	Tasselli ric. / Repl. dowels	35		45	4	8033183567383
150402R	Tasselli ric. / Repl. dowels	40		70	4	8033183561930
150403R	Tasselli ric. / Repl. dowels	50		94	2	8033183568700
150404R	Tasselli ric. / Repl. dowels	60		1560	2	8033183568717



150503 MAZZUOLA CON TESTA IN GOMMA WOODEN Mallet FOR MASONRY

- Testa bombata in gomma per martellare parti delicate
Rounded rubber head for hammering delicate parts
- Manico in legno
Wooden handle

Codice	Peso testa / Head weight gr	mm	gr	📦	Barcode
150503	300	310	305	6	8033116548601
150505	500	320	445	6	8033116548618
150506	600	320	575	4	8033116548625
150507	700	320	620	4	8033116548632
150510	1000	320	815	2	8033116548649



150601 MAZZUOLA CON TESTA IN RAME
Mallet with copper head

- Doppia testa quadra piana in rame
Double square flat head in copper
- Manico in legno
Wooden handle



Codice	Peso testa / Head weight gr	mm	gr		Barcode
150601	200	260	245	6	8033116548656
150602	300	260	410	6	8033116548663
150603	400	260	490	6	8033116548670
150604	500	300	555	6	8033116548687
150605	600	300	635	4	8033116548694

Codice	Peso testa / Head weight gr	mm	gr		Barcode
150606	800	300	785	4	8033116548700
150607	1000	330	1150	2	8033116531689
150608	1500	315	1700	2	8033116548717
150609	2000	315	2135	2	8033116548724

670069 MAZZA COPPIA IN FIBRA
Sledge hammer in fiber

- Doppia testa quadra piana
Double flat square head



Codice	Peso testa / Head weight gr	mm	gr		Barcode
670069	3000	900	4000	1	8033183571168
670064	4000	900	5000	1	8033183568267
670065	5000	900	6000	1	8033183571151
670058M	Manico ricambio / Replacement handle	900	1000	10	8033183560537

670063 MAZZA COPPIA IN LEGNO
Wooden sledge hammer

- Doppia testa quadra piana
Double flat square head



Codice	Peso testa / Head weight gr	mm	gr		Barcode
670063	3000	900	4800	1	8033183846310
660065	Manico ricambio / Replacement handle	900	800	10	8033183599094

670058 MAZZA GEMMA IN FIBRA
Stoning hammer in fiber

- Tagliente spigolato e lucidato
Edged and polished edge



Codice	Peso testa / Head weight gr	mm	gr		Barcode
670058	4000	900	5000	1	8033183554239
670058MP	Manico ricambio / Replacement handle	900	1000	10	8033183560537

ALTO STANDARD QUALITATIVO

HIGH QUALITY STANDARD

08



PUNTA A PUNTA
POINT TO POINT



PUNTA A INTAGLIO
CARVING POINT



IMPRONTA ESAGONALE
HEXAGONAL IMPRINT



UTILIZZO TRAMITE MARTELLO
USE BY HAMMER



ATTACCO SDS MAX
ATTACK SDS MAX



ATTACCO SDS PLUS
ATTACK SDS PLUS

203 Scalpelli
Chisels

204 Scalpelli attacco SDS
SDS shank chisels

206 Scalpelli esagonali
Hexagonal chisels

Scalpellini Chisels

238204 SGORBIE PER LEGNO

GOUGES FOR WOOD

Tipo a taglio / Shear type

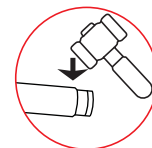

- ◆ Impugnatura in legno di faggio che può essere utilizzata con un martello di legno o un martello di gomma
Beech wood handle that can be used with a wooden hammer or rubber mallet
- ◆ Lama concava in acciaio al cromo vanadio di alta qualità, che dona agli scalpelli una stabilità particolarmente elevata per una lunga durata
Concave blade made of high quality chrome vanadium steel, which gives the chisels a particularly high stability for a long service life
- ◆ Bordi smussati ed estremamente affilati
Beveled and extremely sharp edges

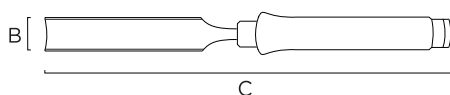

Codice	B mm	C mm	gr	📦	Barcode
238206	6	255	79	6	8033116549615
238208	8	255	93	6	8033116549622
238210	10	255	112	6	8033116549639

Codice	B mm	C mm	gr	📦	Barcode
238212	12	255	115	6	8033116549646
238216	16	255	130	6	8033116549653
238220	20	295	195	6	8033116549660

237601 SCALPELLI PER LEGNO

CHISELS FOR WOOD

Tipo a taglio / Shear type

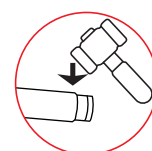

- ◆ Impugnatura in legno di faggio che può essere utilizzata con un martello di legno o un martello di gomma
Beech wood handle that can be used with a wooden hammer or rubber mallet
- ◆ Lama piana in acciaio al cromo vanadio di alta qualità, che dona agli scalpelli una stabilità particolarmente elevata per una lunga durata
Flat blade made of high quality chrome vanadium steel, which gives the chisels a particularly high stability for a long service life
- ◆ Bordi smussati ed estremamente affilati
Beveled and extremely sharp edges

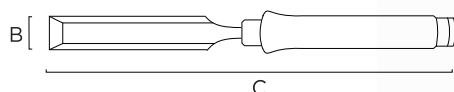

Codice	B mm	C mm	gr	📦	Barcode
237601	6	235	115	6	8033116549509
237602	8	250	116	6	8033116549516
237603	10	250	118	6	8033116549523
237612	12	250	141	6	8033116549530
237614	14	250	153	6	8033116549547

Codice	B mm	C mm	gr	📦	Barcode
237616	16	235	158	6	8033116549554
237618	18	250	150	6	8033116549561
237620	20	250	171	6	8033116549578
237625	25	250	178	6	8033116549592
237630	30	250	224	6	8033116549608

Scalpelli ad attacco SDS

SDS shank chisels

1 Corpo in acciaio temprato trattato termicamente ad alta qualità che garantisce alte prestazioni e lunga durata.

High quality heat treated hardened steel body which guarantees high performance.

2 Per trapani perforatori ad entrata SDS PLUS.

For SDS PLUS entry drills.

► **SDS Plus** è il bit più piccolo e leggero, confrontabile e intercambiabile con l'originale

SDS Plus is the smallest and lightest bit, comparable and interchangeable with the original

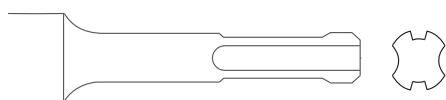

► **SDS Max** è più pesante e più grande e non è compatibile e intercambiabile con qualsiasi punta da trapano

SDS Max is heavier and larger and is not compatible and interchangeable with any drill bit

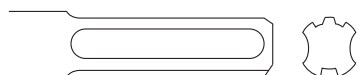

236641 SCALPELLI A PUNTA ATTACCO SDS POINTED CHISELS SDS ATTACHMENT

Tipo a punta / Pointed type

Codice		mm	📦	Barcode
236641	SDS max / SDS max	280	2	8033183585431
236642	SDS max / SDS max	400	2	8033183585448
236643	SDS plus / SDS plus	250	2	8033183585455



238201 SCALPELLI PER TRACCE ATTACCO SDS CHISELS FOR SDS ATTACHMENT TRACKS

Tipo a taglio / Shear type

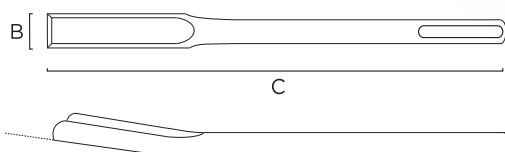

Codice		B mm	C mm	📦	Barcode
238201	SDS max / SDS max	27	300	2	8033183585516
238202	SDS max / SDS max	27	400	2	8033183585523
238203	SDS plus / SDS plus	20	250	2	8033183585530



236004 SCALPELLI PIATTI ATTACCO SDS

SDS FLAT CHISELS

Tipo a taglio / Shear type

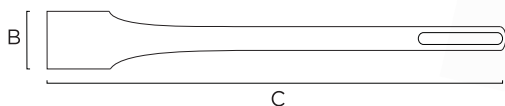

Codice		B mm	C mm		Barcode
236004	SDS max / SDS max	27	280	2	8033183585424
236005	SDS max / SDS max	27	400	2	8033183585417
236006	SDS plus / SDS plus	20	250	2	8033183585400



236541 SCALPELLI A PALETTA ATTACCO SDS

BLADE CHISELS SDS ATTACHMENT

Tipo a taglio / Shear type

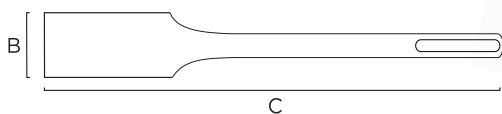

Codice		B mm	C mm		Barcode
236541	SDS max / SDS max	50	300	2	8033183585462
236542	SDS max / SDS max	50	400	2	8033183585479
236543	SDS max / SDS max	80	300	2	8033183585486
236544	SDS plus / SDS plus	115	350	2	8033183585493
236545	SDS plus / SDS plus	40	250	2	8033183585509



236007 SET SCALPELLI + PUNTE SDS PLUS

CHISELS + SDS PLUS BITS SET

- Scalpello piatto attacco **SDS PLUS** ⊖
Flat chisel SDS PLUS connection
- Scalpello a punta attacco **SDS PLUS** ⊕
Pointed chisel SDS PLUS connection
- Scalpello a paletta attacco **SDS PLUS 250mm** ⊖
Paddle chisel 250mm SDS PLUS connection
- Scalpello per tracce attacco **SDS PLUS** ⊖
Trace chisel SDS PLUS connection
- **Punte attacco SDS PLUS:**
1 x (6 x 160; 8 x 160; 12 x 210; 10 x 160) mm
1 x (8 x 210; 10 x 210) mm
1 x (10 x 260; 14 x 260; 12 x 260) mm
Tips SDS PLUS connection:
1 x (6 x 160; 8 x 160; 12 x 210; 10 x 160) mm
1 x (8 x 210; 10 x 210) mm
1 x (10 x 260; 14 x 260; 12 x 260) mm

Codice		gr		Barcode
236007		2300	1	8033183585547



ScalPELLI esagonali

Hexagonal chisels

234201 SCALPELLO PIATTO NERVATO

FLAT RIBBED CHISEL

Tipo a taglio / Shear type

- In acciaio al cromo vanadio
Chrome vanadium steel body

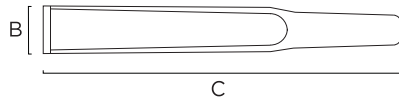

Codice	Pezzi / pieces	B mm	C mm	gr	📦	Barcode
234201		16	125	100	6	8033116548823
234202		20	150	160	6	8033116548830
234203		24	200	335	6	8033116548847
234204		27	250	600	6	8033116548854
234205		33	300	930	6	8033116548861
234301	31	Espositore da banco in lamiera / Counter display in sheet metal 8 x 234201 - 7 x 234202 - 6 x 234203 5 x 234204 - 234205			1	8033116548878



236001 SCALPELLI ESAGONALI PER ELETTRICISTI

PROFESSIONAL SCREWDRIVERS

Tipo a taglio / Shear type

- In acciaio al cromo vanadio con esecuzione verniciata
Chrome vanadium steel body with painted finish

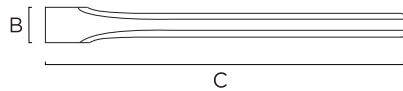

Codice	B mm	C mm	gr	📦	Barcode
236001	14	200	90	10	8033116548885
236002	14	250	120	10	8033116548892
236003	14	300	150	10	8033116548908



236101 SCALPELLI ESAGONALI PER ELETTRICISTI

PROFESSIONAL SCREWDRIVERS

Tipo a punta / Pointed type

- In acciaio al cromo vanadio con esecuzione verniciata
Chrome vanadium steel body with painted finish



Codice	B mm	C mm	gr	📦	Barcode
236101	10	200	90	10	8033116548915
236102	10	250	120	10	8033116548922
236103	10	300	150	10	8033116548939



236525 SCALPELLI ESAGONALI PER ELETTRICISTI
PROFESSIONAL SCREWDRIVERS

Tipo a taglio / *Shear type*

- ♦ In acciaio al cromo vanadio con esecuzione verniciata
Chrome vanadium steel body with painted finish

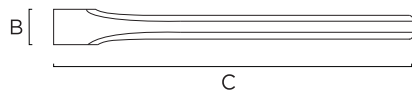

Codice	B mm	C mm	gr		Barcode
236525	22	250	330	6	8033116548960
236530	22	300	500	6	8033116548977
236535	23	350	580	6	8033116548984
236540	22	400	800	6	8033116548991



236625 SCALPELLI ESAGONALI PER ELETTRICISTI
PROFESSIONAL SCREWDRIVERS

Tipo a punta / *Pointed type*

- ♦ In acciaio al cromo vanadio con esecuzione verniciata
Chrome vanadium steel body with painted finish



Codice	B mm	C mm	gr		Barcode
236625	16	250	330	6	8033116549004
236630	16	300	500	6	8033116549011
236635	16	350	580	6	8033116549028
236640	16	400	800	6	8033116549035



236901 ESPOSITORE 48 SCALPELLI ESAGONALI
48 HEXAGONAL CHISELS DISPLAY

In espositore da banco in ferro
In iron counter display

Codice		Barcode
236901	6 x 236525 - 236530 - 236535 - 236540 6 x 236625 - 236630 - 236635 - 236640	



235301 SCALPELLI CROMATI TIPO NORMALE
CHROME CHISELS NORMAL TYPE

Tipo a taglio / *Shear type*

- ♦ In acciaio al cromo vanadio con finitura cromata lucida
Chrome vanadium steel body with a bright chrome finish



Codice	B mm	C mm	gr		Barcode
235301	12	125	75	12	8033116549059
235302	18	130	135	12	8033116549066



235401 SCALPELLI CROMATI TIPO NORMALE CHROME CHISELS NORMAL TYPE

Tipo a punta / Pointed type

- In acciaio al cromo vanadio con finitura cromata lucida
Chrome vanadium steel body with a bright chrome finish



Codice	B mm	C mm	gr		Barcode
235401	10	125	75	12	8033116549080
235402	12	150	135	12	8033116549097
235403	12	200	260	6	8033116549103



236501 PARAMANO PROTETTIVO IN PVC PVC PROTECTIVE HAND GUARD

- Testa esagonale
Hex head

Codice	Ø mm	gr		Barcode
236501	16	140	6	8033116548946
236502	18	127	6	8033116548953



235001 BULINI PUNCHES

Tipo a punta / Pointed type

- In acciaio al cromo vanadio con finitura cromata
Chrome vanadium steel body with a chrome finish

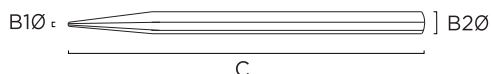

Codice	B1 mm	B2 mm	C mm	gr		Barcode
235001	4	8	100	30	12	8033116549110
235002	4	8	120	60	12	8033116549127
235003	4	8	150	105	12	8033116549134



235101 PUNZONI PUNCHES

Tipo a punta / Pointed type

- In acciaio al cromo vanadio con finitura cromata
Chrome vanadium steel body with a chrome finish

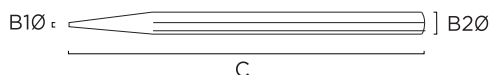





Codice	B1 mm	B2 mm	C mm	gr		Barcode
235101	2	7	120	54	12	8033116549141
235102	3	8	125	54	12	8033116549158
235103	4	10	118	60	12	8033116549165
235104	5	10	150	62	12	8033116549172
235105	6	12	150	64	12	8033116549189



235701 SET 6 ARTICOLI ASSORTITI
SET OF 6 ASSORTED ITEMS





In busta di plastica / In plastic bag

Codice			Barcode
235701	1 x 235002 (Bulino / Punches)		1 8033116549257
	1 x 235101 - 235102 (Punzoni / Punches)		
	1 x 235301 - 235302 (Scalpelli / Chisels)		
	1 x 235402 (Scalpelli / Chisels)		



235801 ESPOSITORE 6 ARTICOLI ASSORTITI
EXHIBITOR OF 6 ASSORTED ITEMS

Su supporto da banco in ferro /
On iron bench support

Codice			Barcode
235801	1 x 235002 (Bulino / Punches)		1 8033116549264
	1 x 235101 - 235102 (Punzoni / Punches)		
	1 x 235301 - 235302 (Scalpelli / Chisels)		
	1 x 235402 (Scalpelli / Chisels)		



235201 CACCIASPINE
HUNTERS

♦ In acciaio al cromo vanadio con finitura cromata lucida
Chrome vanadium steel body with a bright chrome finish



Codice	Pezzi / pieces	B1 mm	B2 mm	C mm	gr		Barcode
235201		1,5	7	110	33	12	8033116549196
235202		2	7	115	37	12	8033116531658
235203		4	8	150	63	12	8033116549202
235204		5	8	165	75	12	8033116549219
235205		6	8	175	115	12	8033116531665
235206		7	10	180	135	12	8033116549226
235501	6	Set in busta di plastica / Plastic bag 235201 - 235202 - 235203 - 235204 - 235205 - 235206			420	1	8033116549257
235601	6	Set su u supporto da banco in ferro / On iron bench support 235201 - 235202 - 235203 - 235204 - 235205 - 235206			640	1	8033116549240



FORNITURE E SICUREZZA PER L'EDILIZIA

BUILDING SUPPLIES AND SAFETY



09



LINEA PRO
PRO LINE



CONFORME AGLI STANDARD EUROPEI
COMPLIES WITH EUROPEAN STANDARDS



EN 388

**CONFORME ALLA NORMATIVA CONTRO
I RISCHI RIGUARDANTI I LAVORI MECCANICI**
COMPLIES WITH THE REGULATION AGAINST RISKS
RELATING TO MECHANICAL WORKS

212 Allestimento cantiere
Construction site preparation

216 Antinfortunistica
Accident prevention

219 Impermeabilizzazione
Waterproofing

09

Allestimento cantiere

Construction site preparation

660015M BADILE IN ACCIAIO TEMPERATO

TEMPERED STEEL SHOVEL

- Testa a punta in acciaio temperato con bordi piegati
Pointed head in tempered steel with folded edges
- Manico in legno di faggio
Beech wood handle

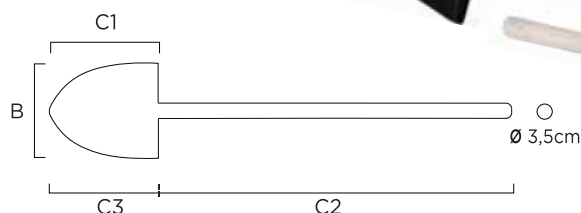

Codice		B X C1 cm	C2/C3 cm	gr		Barcode
660015M	Testa + manico / Head + handle		163	1800	3	8033183563415
660015	Testa / Shovel head	28 x 35		940	6	8033183554703
660050	Manico curvo / Curved handle		140		5	8033183576637

670055 BADILE SUPERLEGGERO IN ALLUMINIO

SUPERLIGHT ALUMINUM SHOVEL

- Testa in lega di alluminio resistente alla corrosione con bordi piegati
Corrosion resistant aluminum alloy head with folded edges
- Manico in legno
Wood handle

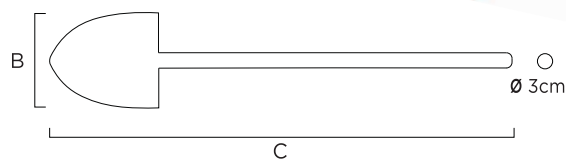

Codice		B cm	C cm	gr		Barcode
670055	Testa a punta + manico / Pointed head + handle	30	160	1100	1	8033183556400
670056	Testa tonda + manico / Round head + handle	30	155	1100	1	8033183556455

660029 SECCHIELLO PER MURATORE
 BUCKET FOR MASON

- ♦ Realizzato in materiale plastico molto leggero e resistente agli urti
Made of very light and impact resistant plastic material
- ♦ Sottile manico pieghevole in metallo
Slim folding metal handle
- ♦ Facile da pulire e resistente alla ruggine
Easy to clean and rust resistant

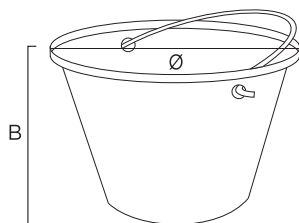

Codice	Capacità / Capacity L	ø mm	B mm	gr		Barcode
660029	10	360	230	500	5	8033183573575

Marcatura e tracciatura

Marking & tracing

604001 TRACCIALINEE IN ABS RICARICABILE
 RECHARGEABLE ABS LINE MARKER

- ♦ Custodia ergonomica in materiale antiurto con manovella
Ergonomic case in shockproof material with crank
- ♦ Filo in cotone 30m
Cotton thread 30m

Codice	mm	gr		Barcode
604001	300	72	10	8033183550422



604005 POLVERE PER TRACCIALINEE
 POWDER FOR MARKER

- ♦ Flacone in plastica blu
Blue plastic bottle

Codice	gr		Barcode
604005	180	10	8033183557575



604002 SET TRACCIALINEE + POLVERE
 LINE MARKER + POWDER SET

- ♦ Traccialinee in ABS antiurto: cod. 604001
Shockproof ABS line striper: cod. 604001
- ♦ Polvere per traccialinee 180gr: cod. 604005
Line marking powder 180gr: cod. 604005

Codice		Barcode
604002	10	8033183560223



875030F OLIAIORE PROFESSIONALE CON FLACONE PROFESSIONAL OILER WITH BOTTLE

- Serbatoio in robusto acciaio laccato
Tank in sturdy lacquered steel
- Completo di pompa a pressione in metallo per l'erogazione manuale dell'olio
Complete with metal pressure pump for dispensing oil

Codice		Capacità / Capacity L		Barcode
875030F	Canna flessibile / <i>Flexible barrel</i>	200	5	8033183550385
875031F	Canna flessibile / <i>Flexible barrel</i>	300	5	8033183550408
875032F	Canna flessibile / <i>Flexible barrel</i>	500	5	8033183550484
875030R	Canna fissa / <i>Fixed barrel</i>	200	5	8033183550392
875031R	Canna fissa / <i>Fixed barrel</i>	300	5	8033183550453
875032R	Canna fissa / <i>Fixed barrel</i>	500	5	8033183550491



875107F OLIAIORE CON FLACONE PROFESSIONAL OILER WITH BOTTLE

- Serbatoio in plastica
Plastic tank
- Completo di pompa a pressione in metallo per l'erogazione manuale dell'olio
Complete with metal pressure pump for dispensing oil

Codice		Capacità / Capacity L		Barcode
875107F	Canna flessibile / <i>Flexible barrel</i>	200	5	8033183550323
875108F	Canna flessibile / <i>Flexible barrel</i>	300	5	8033183550347
875109F	Canna flessibile / <i>Flexible barrel</i>	500	5	8033183550361
875107R	Canna fissa / <i>Fixed barrel</i>	200	5	8033183550330
875108R	Canna fissa / <i>Fixed barrel</i>	300	5	8033183550354
875109R	Canna fissa / <i>Fixed barrel</i>	500	5	8033183550378



600006 MATITA DA MURATORE TONDA ROUND MASON PENCIL

- Corpo in legno a sezione tonda
Round section wood body

Codice		mm		Barcode
600006		240	10	8033183558404



600007 MATITA DA MURATORE OVALE OVAL MASON PENCIL

- Corpo in legno a sezione ovale
Oval section wood body

Codice		mm		Barcode
600007	Per falegname / <i>For carpenter</i>	240	10	8033183559128
600007M	Per marmista / <i>For marble worker</i>	240	10	8033183562210



875501 PUNTA PROFESSIONALE PER TRACCIARE PROFESSIONAL MARKING POINT

- Corpo in acciaio speciale temprato con esecuzione brunita
Special hardened steel body with burnished execution
- Impugnatura in materiale plastico
Plastic handle
- Punta diritta e piegata a 110°
Tips straight and bent at 110°

Codice	mm		Barcode
875501	220	10	8033183559081



875502 PENNA PROFESSIONALE PER TRACCIARE PROFESSIONAL MARKING PEN

- Corpo in alluminio con clip di fissaggio
Aluminum body with fixing clip
- Impugnatura ergonomica in gomma antiscivolo
Ergonomic handle in non-slip rubber
- Punta in metallo duro intercambiabile
Interchangeable hard metal tip

Codice	mm		Barcode
875502	117	10	8033183571519
875506	Punta di ricambio / <i>Replacement tip</i>		10 8033183571526



875505 PENNA PER TRACCIARE MARKING PEN

- Corpo in alluminio con superficie cromata e clip di fissaggio
Aluminum body with chromed surface and fixing clip
- Punta a sfera in carburo di tungsteno
Ball point in tungsten carbide
- Con cappuccio protettivo per coprire la punta quando non è in uso
With protective cap to cover the tip when not in use

Codice	mm		Barcode
875505	145	10	8033183560421



600005 MATITA A PULSANTE BUTTON PENCIL

- Meccanismo metallico automatico a pulsante
Push-button automatic metal mechanism
- Mina 2B in grafite estraibile a sezione tonda
2B lead in extractable graphite with round section

Codice	mm		Barcode
600005	147	10	8033183558190
600005A	Set matita + 6 mine ricambio Ø 5,6mm / <i>Set of pencils + 6 spare leads Ø 5.6mm</i>		10 8033183558183



UNA MATITA, MOLTEPLICI FUNZIONI!

ONE PENCIL, MULTIPLE FUNCTIONS!

Matita pratica e versatile, progettata con una punta ad ago allungata che raggiunge aree difficili anche dove altri pennarelli per carpentieri non arrivano, inoltre, consente di dipingere su varie superfici come metallo, plastica, vetro, legno, carta, ecc.

Practical and versatile pencil, designed with an elongated needle tip that reaches difficult areas even where other carpenter markers do not reach, in addition, it allows you to paint on various surfaces such as metal, plastic, glass, wood, paper, etc.

600009 MATITA AUTOMATICA CON MARCATORE PER FORI PROFONDI

AUTOMATIC PENCIL WITH MARKER FOR DEEP HOLES

- Realizzata in metallo e gomma di alta qualità con canna sottile che migliora la visibilità nei lavori di precisione e scanalature sul corpo per aumentare l'attrito durante l'uso
Made of high quality metal and rubber with a thin barrel that improves visibility in precision work and grooves on the body for increase friction during use
- L'impugnatura svitabile permette di estrarre la punta che consente di marcare i punti difficilmente accessibili **1**
The unscrewable handle allows you to extract the tip to mark the hardly accessible points
- Temperamatite integrato nella parte superiore la matita che permette di affilare la mina rapidamente **2**
Pencil sharpener integrated into the top the pencil that allows to sharpen the lead quickly
- Meccanismo automatico a pressione per l'avanzamento della mina
Automatic pressure mechanism for pushing forward the pencil lead
- La clip di fissaggio consente di fissare agevolmente la matita alle tasche e impedisce che essa rotoli sulle superfici
The fastening clip allows you to easily attach the pencil to the pockets and prevents it from rolling on surfaces



LEGNO / WOOD



CEMENTO / CONCRETE



METALLI / METALS



PLASTICHE / PLASTIC



CERAMICHE / CERAMICS

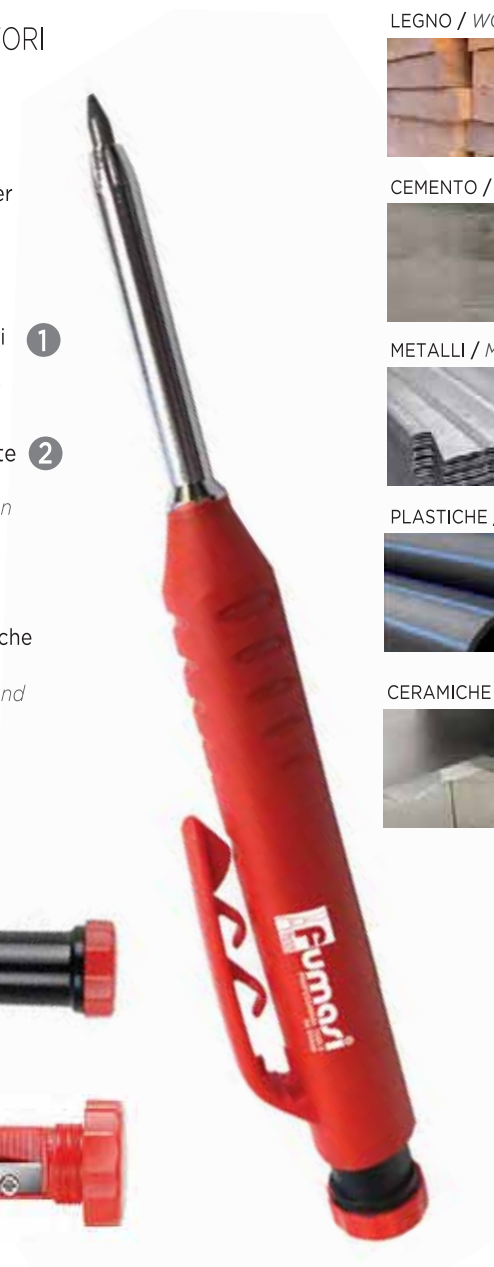

Codice	Pezzi / Pieces	Tipo / Type	Ø mm	Barcode	
600009		Solo matita / Pencil only		8033183846648	
600009G	6	Set mine gialle / Yellow mine set	Cerata / Waxed	2,8	8033183846662
600009R	6	Set mine rosse / Red mine set	Cerata / Waxed	2,8	8033183846655
600009GR	6	Set mine grigio 2B / Gray mine set 2B	In grafite / Graphite	2,8	8033183846679
600009E	24	Espositore / Exhibitor 4 x 600009G - 600009R - 60000PGR; 12 x 600009			8033183846686





Antinfortunistica

Accident prevention

609002 ELMETTO DA LAVORO ECONOMICO ECONOMIC WORK HELMET

- Calotta in polietilene con bordatura in plastica regolabile a 6 punti di ancoraggio
Polyethylene shell with adjustable plastic edging with 6 anchor points
- Fascia antisudore
Sweatband
- Certificato EN 397, isolamento elettrico fino a 440 V
EN 397 certified, electrical insulation up to 440 V

Codice	Colori disponibili / Available colours	Taglia / Size	gr		Barcode
609002		53 - 63	380	5	8033183559722



630080 ELMETTO DA LAVORO ROCK ROCK WORK HELMET



- Calotta in ABS con bordatura in tessuto a 6 punti di ancoraggio
ABS shell with 6 point fabric edging of anchor
- Frontalino tecnico anti-sudore
Sweat-proof technical browband
- Predisposizione per cuffie
Headphone ready
- Sottogola regolabile a 4 punti di ancoraggio e chiusura di sicurezza
Adjustable chin strap with 4 anchoring points and safety closure
- DPI 3ª categoria / certificato EN 397
PPE third category / EN 397 certified

Codice	Colori disponibili / Available colours	Taglia / Size	gr		Barcode
630080	   	52 - 63	470	5	8033183839350



609004F2V MASCHERINE PROTETTIVE CON VALVOLA PROTECTIVE MASKS WITH VALVE

- La presenza della valvola consente una miglior respirazione e riduce l'umidità
The presence of the valve allows for better breathing and reduces humidity
- Per polveri e aereosol a media tossicità
For medium toxicity dusts and aerosols
- Limiti d'impiego: per concentrazione di contaminante fino a 12 X TLV
Limits of use: for contaminant concentration up to 12 X TLV
- DPI 3ª categoria
PPE third category
- Certificato EN 194 + A1
EN 194 + A1 certified

Codice	Tipo / Type	Efficienza filtrante / Filtering efficiency		Barcode	
609004F2V		FFP2	94%	20	8033183839312
609004F3V		FFP3	99%	20	8033183839329



630065 OCCHIALE PROTETTIVO ULTRA LEGGERO
ULTRA LIGHTWEIGHT PROTECTIVE GLASSES

CE
EN 166

- Occhiale in policarbonato ultra leggero dalla calzata aderente
Glasses in ultra-light polycarbonate with a snug fit
- Lenti trasparenti anti-graffio
Clear anti-scratch lenses
- Montatura nera con stanghette flessibili
Black frame with flexible temples
- Certificato EN 166
EN 166 certified



Codice	mm	gr		Barcode
630065	210 x 70 x 70	18	10	8033183833891

630082 CONFEZIONE 200 PAIA TAPPI ANTIRUMORE
PACKAGE OF 200 PAIRS NOISE-PROOF PLUGS

CE
EN 352

- Tappi conici in soffice schiuma di poliuretano a lenta espansione
Tapered plugs in soft slow-expanding polyurethane foam
- Finitura liscia resistente allo sporco per aumentare l'igiene e la durata
Smooth dirt resistant finish to increase hygiene and durability
- Aderiscono bene all'orecchio e offrono un eccellente valore di protezione contro il rumore: 36 DB
They adhere well to the ear and offer excellent protection value against noise: 36 DB
- DPI 3ª categoria / certificato EN 352
PPE third category / EN 352 certified



Codice	gr		Barcode
630082	300	200	8033183839336

630081 CUFFIE ANTIRUMORE AD ARCHETTO
ANTI-NOISE HEADPHONES

CE
EN 352

- Calotta in PVC + spugna e archetto in plastica regolabile
PVC shell + sponge and adjustable plastic headband
- Valore di protezione contro il rumore: 24,6 DB
Noise protection value: 24.6 DB
- DPI 3ª categoria / certificato EN 352
PPE third category / EN 352 certified



Codice	mm	gr		Barcode
630081	190 x 180	175	1	8033183839343

609004 GUANTO IN FILO CONTINUO
CONTINUOUS WIRE GLOVE

CE

- 100% poliestere con rivestimento in una speciale miscela di nitrile + poliuretano su palmo e dita
100% polyester coated in a special nitrile blend + polyurethane on palm and fingers
- Polso elasticizzato
Elasticated wrist



EN 388



Codice	Taglia / Size		Barcode
609004	10	10	8033183558169
609004/9	9	10	8033183845894

609002E GUANTO IN FILO CONTINUO ECONOMICO ECONOMIC CONTINUOUS WIRE GLOVE

- ♦ 100% poliestere con rivestimento in nitrile su palmo e dita
100% polyester with nitrile coating on palm and fingers
- ♦ Polso elasticizzato
Elasticated wrist

Codice	Taglia / Size	📦	Barcode
609002E	7	10	8033183836311
609004E	10	10	8033183558176
609005E	9	10	803318358546
609008E	8	10	8033183836199
609009E	11	10	8033183836205



EN 388

609001P GUANTO IN PELLE FIORE BOVINA GLOVE IN COWHIDE GRAIN LEATHER

- ♦ Rivestimento in pelle fiore bovina sia sul dorso che sul palmo
avente capacità di estrema elasticità e resistenza
*Cowhide grain leather lining both on the back and on the palm
having the ability of extreme elasticity and resistance*
- ♦ Palmo senza cuciture che rende il guanto più confortevole
Seamless palm that makes the glove more comfortable
- ♦ Polso orlato con elastico stringipolso interno
Cuffs edged with internal elastic cuffs
- ♦ Certificato EN 420 - 388
EN 420 - 388 certified

Codice	Taglia / Size	📦	Barcode
609001P	10	10	8033183561886
609002P	9	10	8033183583642
609003P	7	10	8033183840363
609004P	8	10	8033183840370
609005P	11	10	8033183840387



EN 352



EN 388

► Per specifiche sulla tasca vedi pag. 294 "BORSE E CONTENITORI"
For specifics about the bag see pag. 294 "BAGS AND CONTAINERS"

100472 TROUSSE CINTURA PER CARTONGESSISTA TROUSSE BELT FOR CARTOON PLASTER

- ♦ Cesovia per lamiera taglio dritto: cod. 229501
Straight cut sheet metal shears: cod. 229501
- ♦ Cutter in ABS: cod. 232101
ABS cutter: cod. 232101
- ♦ Flessometro magnetico 5 mt x 19 mm: cod. 601007
Magnetic tape measure 5 mt x 19 mm: cod. 601007
- ♦ Doppio metro pieghevole: cod. 600007
Double folding rule: cod. 600007
- ♦ Tasselli multiuso 4 settori + viti: cod. 620006
Multi-purpose plugs 4 sectors + screws: cod. 620006

Codice	📦	Barcode
100472	1	8033183846808



Impermeabilizzazione

Waterproofing

Pistole schiuma

Foam guns

- 1** Ugello in rame + tubo conico resistenti alla corrosione e facili da pulire.
Copper nozzle + conical tube corrosion resistant and easy to clean.
- 2** Valvola di regolazione del flusso della schiuma.
Foam flow adjustment valve.
- 3** Valvola di ingresso della schiuma che garantisce un facile collegamento con la pistola.
Foam inlet valve that ensures easy connection with the gun.
- 4** Il grilletto di controllo garantisce un comodo utilizzo e riduce notevolmente i consumi economici e gli sprechi.
The control trigger ensures comfortable use and greatly reduces economic consumption and waste.



623009 PISTOLA SCHIUMA IN TEFLON TEFLON FOAM GUN

- Modello professionale progettato per dosare la schiuma di poliuretano nel modo più accurato possibile
Professional model designed to dose polyurethane foam as accurately as possible
- Rivestita completamente in Teflon antiaderente
Fully coated in non-stick Teflon
- Impugnatura ergonomica in materiale gommato
Ergonomic rubberized handle



Codice	mm	gr		Barcode
623009	330	370	12	8033183845917

623010 PISTOLA PER SCHIUMA DI METALLO METAL FOAM GUN

- ♦ Design robusto in metallo che le dona resistenza e ugello in ottone
Sturdy metal design that gives it resistance and brass nozzle
- ♦ Adattatore teflonato
Teflon-coated adapter
- ♦ Impugnatura comoda in materiale plastico con baricentro ottimale
Comfortable plastic handle with optimal center of gravity

Codice	mm	gr		Barcode
623010	330	270	12	8033183845924



Pistole per silicone Silicone guns

623007 PISTOLA PER SILICONE ULTRA PROFESSIONAL ULTRA PROFESSIONAL SILICONE GUN

- ♦ Struttura estremamente robusta con saldature a filo continuo, e passo corto per massima precisione
Extremely robust structure with continuous wire welding, and short wheelbase for maximum precision
- ♦ Molla rinforzata e meccanismo potenziato acciaio-nylon che permette con il minimo sforzo la massima resa
Reinforced spring and enhanced steel-nylon mechanism that allows with minimum effort maximum yield
- ♦ Eccellente per ancoranti chimici impegnativi ma non teme alcun tipo di materiale
Excellent for demanding chemical anchors but not afraid of any type of material
- ♦ **Rapporto di spinta: 29:1**
Thrust ratio: 29:1

Codice	Cartucce / Cartridges ml	mm	gr		Barcode
623007	400	340	800	12	8033183845955



623005 PISTOLA PER RESINA PROFESSIONALE EXTRA EXTRA PROFESSIONAL RESIN GUN

- ♦ Grazie alla struttura estremamente robusta non teme estrusione a basse temperature
Thanks to the extremely robust structure, it does not fear extrusion at low temperatures
- ♦ Molla rinforzata e fermo di fine corsa
Reinforced spring and end stop
- ♦ Eccellente per ancoranti chimici impegnativi ma non teme alcun tipo di materiale
Excellent for demanding chemical anchors but not afraid of any type of material
- ♦ **Rapporto di spinta: 26:1**
Thrust ratio: 26:1
- ♦ **Potenza di spinta: 3600W**
Thrust power: 3600W

Codice	Cartucce / Cartridges ml	mm	gr		Barcode
623005	400	340	1000	12	8033183578754



623008 PISTOLA PER SILICONE PROFESSIONALE EXTRA EXTRA PROFESSIONAL SILICONE GUN



- Struttura estremamente robusta con saldature a filo continuo, resistente anche a basse temperature
Extremely robust structure with continuous wire welding, resistant even to low temperatures
- Speciale meccanismo che abbatte completamente lo sforzo e garantisce la massima resa
Special mechanism that completely reduces the effort and guarantees maximum yield
- Molla rinforzata ad alta resistenza
High strength reinforced spring
- Saldature filo continuo
Continuous wire welding
- Speciale frizione fine corsa
Special end-of-stroke clutch
- Per silicone, resina e ancoranti chimici
For silicone, resin and chemical anchors
- **Rapporto di spinta: 26:1**
Thrust ratio: 26:1
- **Potenza di spinta: 3600W**
Thrust power: 3600W



Codice	Cartucce / Cartridges ml	mm	gr		Barcode
623008	300	340	340	12	8033183845931

623006 PISTOLA PER SILICONE RINFORZATA REINFORCED SILICONE GUN



- Molla rinforzata ad alta resistenza
High strength reinforced spring
- Eccellente per siliconi e sigillanti
Excellent for silicones and sealants
- **Rapporto di spinta: 18:1**
Thrust ratio: 26:1
- **Potenza di spinta: 2000W**
Thrust power: 3600W



Codice	Cartucce / Cartridges ml	mm	gr		Barcode
623006	300	340	400	12	8033183845900

623003 PISTOLA PER SILICONE SILICON GUN

- Robusta impugnatura ergonomica in alluminio e maniglia in lega di zinco
Sturdy ergonomic aluminum handle and zinc alloy handle
- Porta cartuccia orientabile in lamiera con verniciatura a polvere
Swiveling cartridge holder in powder-coated sheet metal
- Meccanismo di spinta a leva rinforzata per garantire maggiore potenza
Reinforced lever thrust mechanism to ensure greater power
- Da utilizzarsi con cartucce diametro 50 mm
To be used with cartridges diameter 50 mm
- **Per silicone**
For silicone



Codice	Cartucce / Cartridges ml	mm	gr		Barcode
623003	300	360	550	10	8033183557421

623004 PISTOLA PER SILICONE PROFESSIONALE PROFESSIONAL SILICON GUN

- Corpo tubolare in alluminio con serbatoio
Tubular aluminum body with tank
- Include beccuccio in plastica
With plastic spout
- Dispositivo di arresto dell'erogazione del materiale
Device for stopping the dispensing of the material

Codice	mm		Barcode
623004	360	5	8033183558039



623001 PISTOLA PER SILICONE IN LAMIERA GUN FOR SHEET METAL SILICON

- Corpo ad asta dentellata in lamiera
Sheet metal body with serrated rod
- Movimento a cremagliera
Rack movement

Codice	mm		Barcode
623001	325	5	8033183550309



623002 PISTOLA PER SILICONE SILICON GUN

- Corpo a due aste in lamiera verniciata
Two-rod body in painted sheet metal
- Avanzamento a frizione
Clutch movement

Codice	mm		Barcode
623002	340	5	8033183579263



LA DIFFERENZA NEI DETTAGLI

THE DIFFERENCE IN THE DETAILS



LINEA PRO
PRO LINE

224 Cazzuole e cazzuolini
Trowels and small trowels

230 Frattoni
Goldsmith's shears

Accessori per la copertura

Accessories for the coverage

Cazzuole e cazzuolini

Trowels and small trowels

- 1** Lama in acciaio speciale, ad alta flessibilità.
Special steel blade, highly flexible.
- 2** Impugnatura ergonomica in legno di faggio di alta qualità / in bicomponente antiscivolo, resistente agli agenti corrosivi, adatta per una migliore presa dell'utensile ed un maggior comfort durante l'utilizzo.
Ergonomic handle made of high quality beech wood / two-component non-slip, resistant to corrosive agents, suitable for a better grip of the tool and greater comfort during use.

237118P CAZZUOLA PUNTA TONDA
 ROUND TIP TROWEL

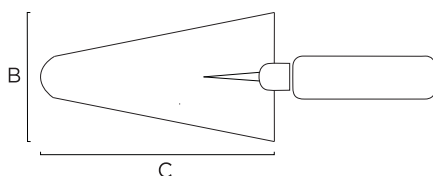

Codice	B mm	C mm	📦	Barcode
237118P	110	180	12	8033183587800
237119P	115	190	12	8033183587817
237120P	120	200	12	8033183587619



Codice	B mm	C mm	📦	Barcode
237121P	120	210	12	8033183587824
237122P	125	220	12	8033183587831

237318P CAZZUOLA PUNTA QUADRA
 SQUARE TIP TROWEL

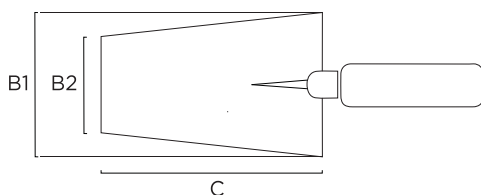

Codice	B1 mm	B2 mm	C mm	📦	Barcode
237318P	100	75	180	12	8033183587893
237319P	110	80	190	12	8033183587902
237320P	110	80	200	12	8033183587916



Codice	B1 mm	B2 mm	C mm	📦	Barcode
237321P	120	85	210	12	8033183587923
237322P	125	58	220	12	8033183587930

237414SP CAZZUOLINO PUNTA TONDA
ROUND TIP SMALL TROWEL

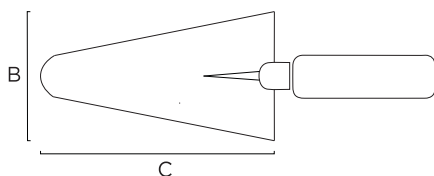

Codice		B mm	C mm		Barcode
237414SP	Manico bimat. / <i>Bi-material handle</i>	70	140	12	8033183587374
237416SP	Manico bimat. / <i>Bi-material handle</i>	80	160	12	8033183587381
237414P	Manico legno / <i>Wooden handle</i>	70	140	12	8033183587343
237416P	Manico legno / <i>Wooden handle</i>	80	160	12	8033183587350



237314SP CAZZUOLINO PUNTA QUADRA
SQUARE TIP SMALL TROWEL

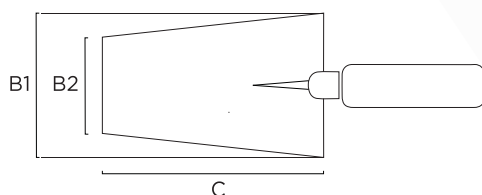

Codice		B1 mm	B2 mm	C mm		Barcode
237314SP	Manico bimatateriale / <i>Bi-material handle</i>	80	63	140	12	8033183587374
237316SP	Manico bimatateriale / <i>Bi-material handle</i>	95	75	160	12	8033183587381
237214P	Manico legno / <i>Wooden handle</i>	80	63	140	12	8033183587404
237216P	Manico legno / <i>Wooden handle</i>	95	75	160	12	8033183587411



237514SA CAZZUOLINO PUNTA ACUTA
SHARP TIP SMALL TROWEL

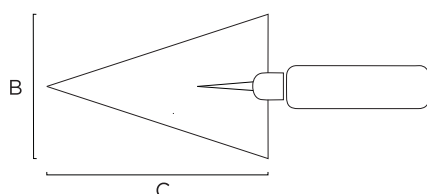

Codice		B mm	C mm		Barcode
237514SA	Manico bimat. / <i>Bi-material handle</i>	72	140	12	8033183587497
237516SA	Manico bimat. / <i>Bi-material handle</i>	75	160	12	8033183587503
237512A	Manico legno / <i>Wooden handle</i>	68	120	12	8033183587459
237514A	Manico legno / <i>Wooden handle</i>	72	140	12	8033183587466
237516A	Manico legno / <i>Wooden handle</i>	75	160	12	8033183587473



237514SO CAZZUOLINO FOGLIA ULIVO
OLIVE LEAF SMALL TROWEL

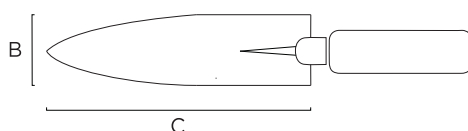

Codice		B mm	C mm		Barcode
237514SO	Manico bimat. / <i>Bi-material handle</i>	32	140	12	8033183587558
237516SO	Manico bimat. / <i>Bi-material handle</i>	37	160	12	8033183587565
237514O	Manico legno / <i>Wooden handle</i>	32	140	12	8033183587527
237516O	Manico legno / <i>Wooden handle</i>	37	160	12	8033183587534



237512G CAZZUOLINO LINGUA DI GATTO
CAT'S TONGUE TROWEL

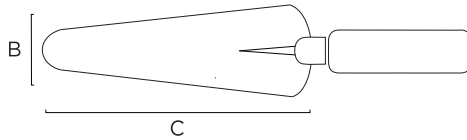

Codice		B mm	C mm		Barcode
237512G	Manico bimat. / Bi-material handle	40	120	12	8033183569134
237514G	Manico bimat. / Bi-material handle	45	140	12	8033183561527
237516G	Manico bimat. / Bi-material handle	55	160	12	8033183569141
237512	Manico legno / Wooden handle	40	120	12	8033116544436
237514	Manico legno / Wooden handle	45	140	12	8033116549424
237516	Manico legno / Wooden handle	55	160	12	8033116549431



237711 CAZZUOLA PER ANGOLI INTERNI A 90°
TROWEL FOR INTERNAL CORNERS 90°

- ♦ Realizzato in acciaio inossidabile di alta qualità con superficie liscia, che consente di avere angoli puliti
Made of high quality stainless steel with smooth surface, which allows for clean corners
- ♦ Impugnatura ergonomica blu
Blue ergonomic handle



Codice		mm	gr		Barcode
237711		110 x 110 x 80	170	12	8033183569165



09

237702 CAZZUOLA PER ANGOLI ESTERNI A 90°
TROWEL FOR EXTERNAL CORNERS 90°

- ♦ Realizzato in acciaio inossidabile di alta qualità con superficie liscia, che consente di avere angoli puliti
Made of high quality stainless steel with smooth surface, which allows for clean corners
- ♦ Impugnatura ergonomica blu
Blue ergonomic handle



Codice		mm	gr		Barcode
237702		110 x 110 x 80	170	12	8033183569158



1

Lama in acciaio al carbonio di buona qualità.

High quality tempered steel blade to make it more flexible.

2

Impugnatura ergonomica in legno con giunto tra manico e lama.

Simple shape lacquered beech wood handle.

237016 CAZZUOLA PUNTA TONDA
ROUND TIP TROWEL

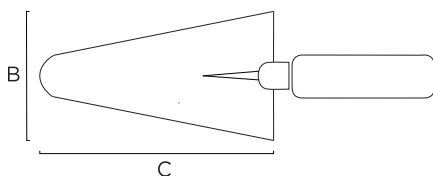

Codice	B mm	C mm	Icona	Barcode
237016	100	160	12	8033183588142
237018	110	180	12	8033116549271
237019	115	190	12	8033183588159

Codice	B mm	C mm	Icona	Barcode
237020	120	200	12	8033116549288
237021	120	210	12	8033183588166
237022	125	220	12	8033116549288

237018S CAZZUOLA PUNTA TONDA STRETTA
NARROW ROUND TIP TROWEL

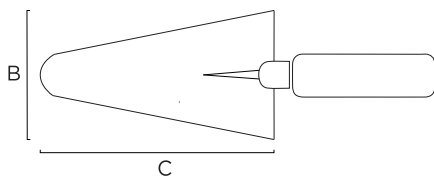

Codice	B mm	C mm	Icona	Barcode
237018S	110	180	12	8033183560070
237019S	115	190	12	8033183588111
237020S	120	200	12	8033183558046
237021S	120	210	12	8033183588128
237022S	125	220	12	8033183561855

237216 CAZZUOLA PUNTA QUADRA
SQUARE TIP TROWEL

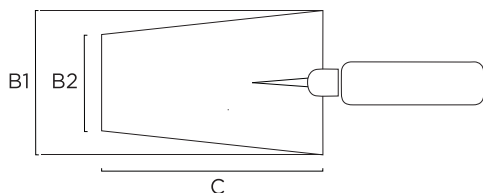

Codice	B1 mm	B2 mm	C mm	Icona	Barcode
237216	95	75	160	12	8033183588180
237218	100	80	180	12	8033116549332
237219	110	85	190	12	8033183588173
237220	115	90	200	12	8033116549349
237221	120	100	210	12	8033183588197
237222	125	105	220	12	8033116549356

237412 CAZZUOLINO PUNTA TONDA
ROUND TIP SMALL TROWEL

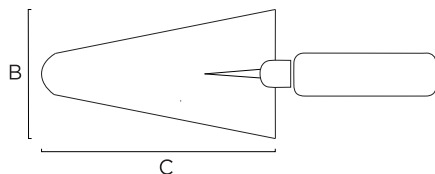

Codice	B mm	C mm		Barcode
237412	65	120	12	8033116549394
237414	70	140	12	8033116549400
237416	80	160	12	8033116547417



237212Q CAZZUOLINO PUNTA QUADRA
SQUARE TIP SMALL TROWEL

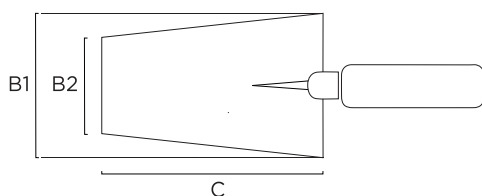

Codice	B1 mm	B2 mm	C mm		Barcode
237212Q	80	63	120	12	8033183846563
237214Q	95	75	140	12	8033183846556
237216Q	105	80	160	12	8033183846549



237602P SPATOLA PER STUCCO PROFESSIONALE
PROFESSIONAL SPATULA FOR STUCCO

- ♦ Lama in acciaio INOX
Stainless steel blade
- ♦ Manico in legno
Wooden handle

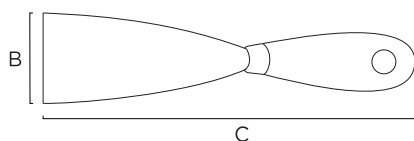

Codice	B mm	C mm		Barcode
237602P	20	195	12	8033183588593
237603P	30	195	12	8033183587626
237604P	40	200	12	8033183588609
237605P	50	200	12	8033183588616
237606P	60	210	12	8033183588623
237607P	70	210	12	8033183588630
237608P	80	210	12	8033183588647
237609P	90	215	12	8033183588654
237610P	100	215	12	8033183588661
237612P	120	215	12	8033183588678



237602E SPATOLA PER STUCCO
SPATULA FOR STUCCO

- ♦ Lama in acciaio al carbonio
Carbon steel blade
- ♦ Manico in legno
Wooden handle

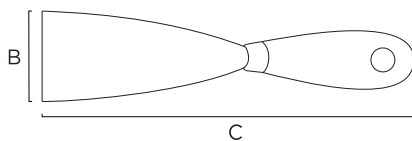

Codice	B mm	C mm		Barcode
237602E	20	190	12	8033183588685
237603E	30	190	12	8033183588692
237604	40	195	12	8033116549448
237605	50	195	12	8033116549455
237606	60	210	12	8033116549462

Codice	B mm	C mm		Barcode
237607	70	210	12	8033116549479
237608	80	215	12	8033116549486
237610	100	215	12	8033116549493
237612E	120	215	12	8033116589125

237631 SPATOLA LISCIA PER CARROZZIERE
SMOOTH SPATULA FOR CARRET

- ♦ Acciaio temperato blu
Blue tempered steel

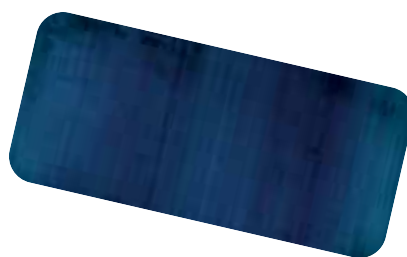
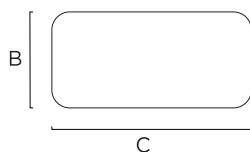

Codice	B mm	C mm		Barcode
237631	20	120	12	8033183588708
237632	30	120	12	8033183588715
237633	40	120	12	8033183588722
237634	50	120	12	8033183588739
237635	60	120	12	8033183588746
237636	70	120	12	8033183588753

Codice	B mm	C mm		Barcode
237637	80	120	12	8033183588760
237638	90	120	12	8033183588777
237639	100	120	12	8033183588784
237640	110	120	12	8033183588791
237641	120	120	12	8033183588807
237642	140	120	12	8033183588814

237644 SPATOLONE DOPPIA GOMMA
DOUBLE RUBBER SPATULA

- ♦ Telaio in lamiera zincata
Frame in galvanized sheet
- ♦ Doppia gomma per un'efficacia maggiore
Double rubber for greater effectiveness

Codice	mm		Barcode
237644	350	5	8033183588838
237645	450	5	8033183588845
237646	550	5	8033183588852
237647	750	5	8033183588869



Frattoni

Trowels

- 1** Impugnatura ergonomica con speciali incisioni antiscivolo che garantiscono una presa perfetta.
Ergonomic handle with special anti-slip engravings that guarantee a perfect grip.
- 2** Lama ultra flessibile in acciaio temperato di altissima qualità.
Ultra-flexible blade in very high quality tempered steel.

372801 FRATTONE TIPO USA LAMA LISCIA US TYPE TROWEL WITH SMOOTH BLADE

- ◆ Impugnatura in nylon
Nylon handle

Codice	mm		Barcode
372801	120 x 280	6	8033183558053



372902 FRATTONE TIPO USA LAMA DENTELLATA USA TYPE TROWEL WITH PERFORATED BLADE

- ◆ Impugnatura in nylon
Nylon handle

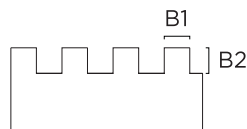

Codice	B1 x B2 mm	mm		Barcode
372902	70 x 70	120 x 280	6	8033183558435
372903	100 x 100	120 x 280	6	8033183560551
372904	120 x 120	120 x 280	6	8033183569882



373101 FRATTONE TIPO USA LAMA LISCIA US TYPE TROWEL WITH SMOOTH BLADE

- ◆ Impugnatura in legno
Wooden handle

Codice	mm		Barcode
373101	120 x 280	6	8033183558916



373202 FRATTONE TIPO USA LAMA DENTELLATA USA TYPE TROWEL WITH PERFORATED BLADE

- ◆ Impugnatura in legno
Wooden handle

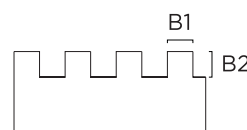

Codice	B1 x B2 mm	mm		Barcode
373202	70 x 70	120 x 280	6	8033183559753
373203	100 x 100	120 x 280	6	8033183559746
373204	120 x 120	120 x 280	6	8033183559760



373001 FRATTONE IN PLASTICA TIPO USA
USA TYPE PLASTIC TROWEL

- Corpo in plastica dura
Hard plastic body
- Impugnatura in nylon
Nylon handle

Codice		mm		Barcode
373001	●	130 x 280	6	8033183560100
373001B	○	130 x 280	6	8033183588579



373801 FRATTONE IN PVC
PVC TROWEL

- Corpo in plastica dura nera
Black hard plastic body
- Manico integrato alla base per maggiore solidità e durata
Integrated handle at the base for greater strength and durability

Codice		mm		Barcode
373801		140 x 420	6	8033183567406
373802		260 x 420	6	8033183567475



373502A FRATTONE IN GOMMASPUGNA
RUBBER TROWEL

- Supporto in alluminio
Aluminum support
- Manico in legno
Wooden handle

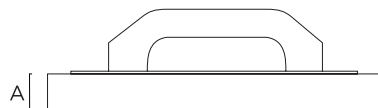

Codice		Porosità / Porosity	mm	A mm		Barcode
373502A	●	Poro fine / Fine pore	140 x 220	15	12	8033183588432
373502B	●	Poro fine / Fine pore	140 x 220	15	12	8033183845993



373504A FRATTONE IN GOMMASPUGNA
RUBBER TROWEL

- Supporto in plastica
Plastic support
- Manico in plastica
Plastic handle

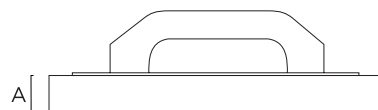

Codice		Porosità / Porosity	mm	A mm		Barcode
373504A	●	Poro fine / Fine pore	140 x 220	15	12	8033183588456
373504B	●	Poro fine / Fine pore	140 x 220	15	12	8033183588548



373506 FRATTONE IN SPUGNA
RUBBER TROWEL

- Supporto in plastica
Plastic support
- Manico in plastica
Plastic handle
- Spugna in cellulosa ad alto potere assorbente color tabacco
High absorbent cellulose sponge in tobacco color

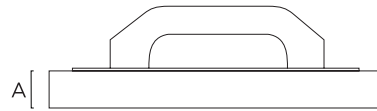

Codice	mm	A mm		Barcode
373506	150 x 290	30	12	8033183588555

373702 FRATTONE PER PIASTRELLE CON FELTRO
TROWEL FOR TILES WITH FELT

- Supporto in plastica
Plastic support
- Manico in plastica
Plastic handle
- Feltro nero in fibra dura ad alto potere abrasivo;
filtro bianco in fibra morbida non abrasivo
*Black felt in hard fiber with high abrasive power;
white filter in soft non-abrasive fiber*

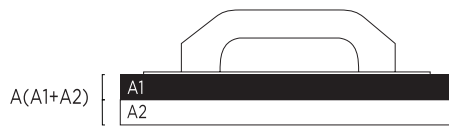

Codice	mm	A mm		Barcode
373702	120 x 250	40	12	8033183588562
373702N	Feltro nero / <i>Black felt</i>	120 x 250	20	8033183588876
373702B	Feltro bianco / <i>White felt</i>	120 x 250	20	8033183588883

373701 FRATTONE IN GOMMA MORBIDA
SOFT RUBBER TROWEL

- Supporto in plastica antiurto
Shockproof plastic support
- Manico in plastica
Plastic handle

Codice	mm		Barcode
373701	110 x 245	12	8033183558626



373102 FRATTONE A 2 MANI LAMA LISCIA
2 HANDS SMOOTH BLADE TROWEL

- Supporto in acciaio temperato
Support in tempered steel
- Manico in legno
Wooden handle

Codice	mm		Barcode
373102	140 x 480	6	8033183588258



374402 FRATTONE A 2 MANI LAMA DENTELLATA 2 HAND PERFORATED BLADE TROWEL

- Supporto in acciaio temperato
Support in tempered steel

- Manico in legno
Wooden handle

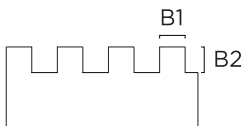

Codice	B1 x B2 mm	mm		Barcode
374402	70 x 70	140 x 480	6	8033183588289
374403	100 x 100	140 x 480	6	8033183588296
374404	120 x 120	140 x 480	6	8033183588302



374001 PIALLA PER GESSO PLANER FOR PLASTER

- Supporto in alluminio
Aluminum support

- Lame in acciaio perfettamente planari
Perfectly planar steel blades

Codice	mm		Barcode
374001	85 x 460	4	8033183557438



238501 STRETTOI A VITE SCREW CLAMP

- Asta in acciaio al manganese silicio e corsoio in acciaio al carbonio verniciato verde
Manganese silicon steel rod and carbon steel slider green painted

- Vite di regolazione interamente zincata
Fully galvanized adjustment screw

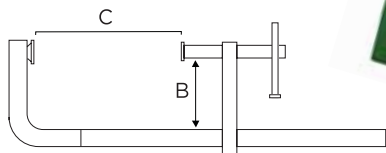

Codice	C mm	B mm	gr		Barcode
238501	200	80	800	10	8033116549677
238502	250	80	900	10	8033116549684
238503	300	90	1200	10	8033116549691
238504	400	90	1300	10	8033116549707
238505	500	100	1900	10	8033116549714
238506	600	100	2100	10	8033116549721
238507	800	100	2500	10	8033116549738
238508	1000	110	3500	10	8033116549745



237643 INTONACATRICE MANUALE MANUAL PLASTER

- Corpo in lamiera con impugnatura comfort in plastica
Sheet metal body with plastic comfort handle

- Pettini in acciaio
Steel combs

Codice	mm	gr		Barcode
237643	264 x 165 x 256	1360	1	8033183588821



PERFEZIONE DELLE MISURE

PERFECTION OF MEASUREMENTS



10



LINEA PRO
PRO LINE



DOPPIO METRO (FRONTE/RETRO)
DOUBLE METER (FRONT / BACK)



MAGNETICO
MAGNETIC



NASTRO BRILLANTE
BRILLIANT RIBBON



NASTRO ANTIRIFLESSO
ANTI-REFLECTIVE TAPE

235 Utensili per misurare
Measuring tools

239 Flessometri
Tape measure

10

Utensili per misurare Measuring tools

875050 CALIBRO A CORSOIO VERNIER CALIPER

- ♦ Acciaio inossidabile temprato
Hardened stainless steel
- ♦ Scala di lettura cromata opaca
Matte chrome reading scale
- ♦ Sistema di bloccaggio a leva
Push-button locking system



Codice	mm	gr		Barcode
875050	150	155	1	8033116531108

875052 CALIBRO A CORSOIO VERNIER CALIPER

- ♦ Acciaio inossidabile temprato
Hardened stainless steel
- ♦ Scala di lettura cromata opaca
Matte chrome reading scale
- ♦ Sistema di bloccaggio a vite
Push-button locking system



Codice	mm	gr		Barcode
875052	150	155	1	8033183560414
875053	200	160	1	8033183571212
875054	300	165	1	8033183571229

875051 CALIBRO A CORSOIO DIGITALE DIGITAL SLIDING CALIPER

- ♦ Acciaio inossidabile temprato con schermo a cristalli liquidi
Hardened stainless steel with liquid crystal screen
- ♦ Sistema di bloccaggio a vite
Screw locking system
- ♦ Sistema di accensione e spegnimento a pulsante
Push button on / off system

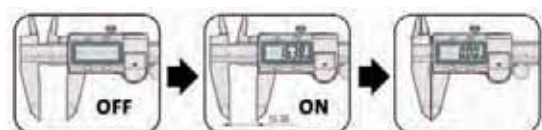

Azzeramento in qualsiasi posizione
Zeroing in any position

Codice	mm	gr		Barcode
875051	150	250	1	8033183559432

875008 SPESSIMETRO
THICKNESS GAUGE

- ♦ 13 lame in acciaio (0,05 - 1,00)
13 steel blades (0.05 - 1.00)
- ♦ Dotato di vite di bloccaggio
Equipped with locking screw

Codice	Spessore lame / Blade thickness	mm	gr		Barcode
875008	0,05 - 0,10 - 0,15 - 0,20 - 0,25 - 0,30 - 0,40 - 0,50 - 0,60 - 0,70 - 0,80 - 0,90 - 1,00	100	100	5	8033183550439



875080 SQUADRA SEMPLICE
SIMPLE RULER

- ♦ Interamente in acciaio indeformabile
Entirely in non-deformable steel





Codice	B mm	C mm		Barcode
875080	70	100	6	8033183561275
875081	100	150	6	8033183571243
875082	135	200	6	8033183571267
875083	165	250	3	8033183571281
875084	200	300	3	8033183562555

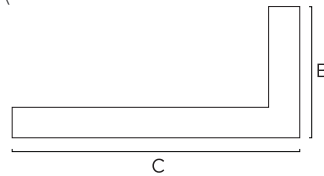

875080E SQUADRA SEMPLICE ECONOMICA
ECONOMIC SIMPLE RULER

- ♦ Interamente in acciaio zincato
Entirely in galvanized steel



Codice	B mm	C mm		Barcode
875080E	70	100	6	8033183571236
875081E	100	150	6	8033183571250
875082E	135	200	6	8033183571274
875083E	170	250	3	8033183571298
875084E	180	300	3	8033183571304
875085E	200	400	3	8033183571311
875086E	250	500	3	8033183571328



875380 SQUADRA A CAPPELLO
TRY SQUARE RULER

- ♦ Interamente in acciaio indeformabile
Entirely in non-deformable steel



Codice	B mm	C mm		Barcode
875380	70	100	4	8033183561268
875381	100	150	4	8033183571441
875382	135	200	4	8033183571458
875383	165	250	2	8033183571465
875384	200	300	2	8033183571472



875380E SQUADRA A CAPPELLO ECONOMICA TRY SQUARE RULE ECONOMIC

- Interamente in acciaio zincato
Entirely in galvanized steel



Codice	B mm	C mm	📦	Barcode
875380E	70	100	6	8033183564665
875381E	100	150	6	8033183558237
875382E	135	200	6	8033183557810
875383E	170	250	3	8033183557827
875384E	180	300	3	8033183571489
875385E	200	400	3	8033183571502
875386E	250	500	3	8033183572233

875070 RIGA SEMIRIGIDA SEMI-RIGID ROW

- Interamente in acciaio inossidabile con superficie opaca
Stainless steel body with matte surface

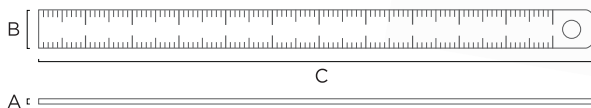

Codice	C mm	B mm	A mm	📦	Barcode
875070	300	30	1	4	8033183562807
875071	500	30	1	4	8033183561060
875072	1000	30	1	4	8033183560964

Codice	C mm	B mm	A mm	📦	Barcode
875073	1500	30	1	4	8033183562791
875074	2000	30	1	4	8033183560971

875470 GONIOMETRO SEMPLICE SIMPLE GONIOMETER

- Interamente in acciaio indeformabile cromato opaco
Entirely in non-deformable matt chromed steel
- Capacità di misura 0 - 180°
Measuring capacity 0 - 180°
- Ghiera di bloccaggio dell'asta
Rod locking ring

Codice		mm	Ø mm	📦	Barcode
875470	Asta scorrevole / Sliding rod	120	80	1	8033183563460
875471	Asta scorrevole / Sliding rod	150	120	1	8033183562845
875472	Asta scorrevole / Sliding rod	200	150	1	8033183561909
875473	Asta scorrevole / Sliding rod	300	200	1	8033183562647

Codice		mm	Ø mm	📦	Barcode
875570		240	120	1	8033183562852
875571		300	150	1	8033183558398
875572		400	200	1	8033183559098

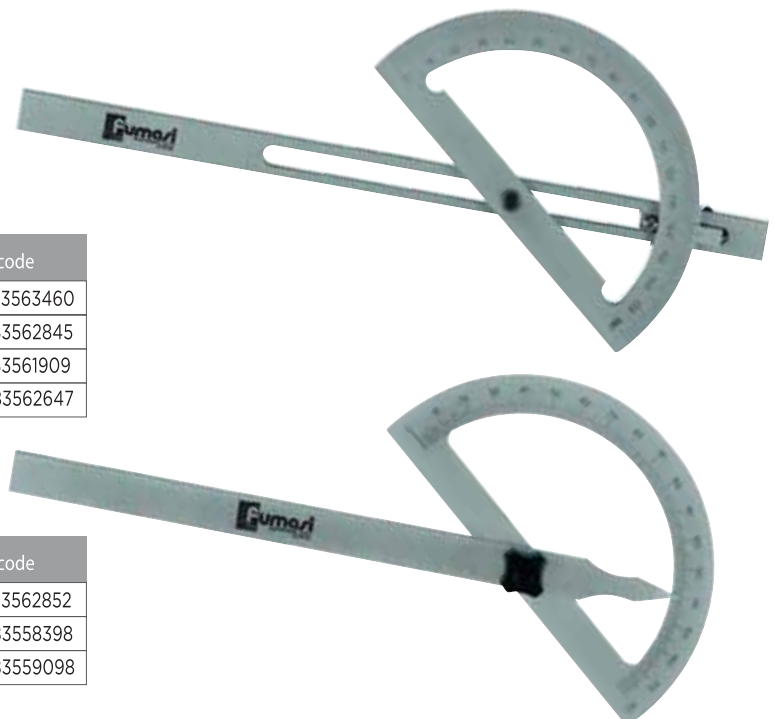

875530 COMPASSO APPUNTITO
POINTED COMPASS

- Interamente in acciaio con punte temperate
Entirely in steel with tempered tips
- Con guida a 1/4 di cerchio e fermo a vite
With 1/4 circle guide and screw stop



Codice	mm		Barcode
875530	150	5	8033183561893
875531	200	5	8033183571557
875532	250	5	8033183557834
875533	300	5	8033183571564

600001 DOPPIO METRO PIEGHEVOLE
DOUBLE FOLDING METER

- Corpo in fibra di vetro
Fiberglass body
- Suddivisione in cm/mm su entrambi i bordi
Subdivision in cm / mm on both edges



Codice	Pezzi / Pieces	mt	gr		Barcode
600001	○	2	119	10	8033116532754
600001E	25	Espositore / Exhibitor art. 600001		1	8033183846044

600002 DOPPIO METRO PIEGHEVOLE
DOUBLE FOLDING METER

- Corpo in legno con laccatura per una maggiore resistenza
Wood body with lacquer for added strength
- Suddivisione in cm/mm su entrambi i bordi con decimali in rosso
Subdivision in cm / mm on both edges with red decimals



Codice	Pezzi / Pieces	mt	gr		Barcode
600002	○●	2	111	10	8033116549752
600002E	25	Espositore / Exhibitor art. 600002		1	8033183846037

600002P DOPPIO METRO PIEGHEVOLE ANTIABRASIVO
DOUBLE FOLDING ANTI-ABRASIVE METER

- Corpo in legno di faggio con finitura anti-abrasione
Beech wood body with anti-abrasion finish
- Rivestimento con smalto a base d'acqua e 2 strati di vernice idrosolubile
Coating with water-based enamel and 2 layers of water-soluble paint
- Suddivisione in cm/mm su entrambi i bordi con decimali in rosso
Subdivision in cm / mm on both edges with red decimals

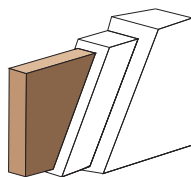
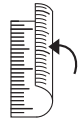

Codice	Pezzi / Pieces	mt	gr		Barcode
600002P	○●	2	111	10	8033183846204
600002PE	25	Espositore / Exhibitor art. 600002P		1	8033183846051

Flessometri

Tape measure

601006 FLESSOMETRO MAGNETICO IN ABS MAGNETIC FLEXOMETER IN ABS

- Custodia in ABS con rivestimento in gomma antiscivolo
ABS case with non-slip rubber coating
- Sistema di bloccaggio a rilascio immediato automatico
Automatic immediate release locking system
- Linguetta con doppio magnete
Double magnet tab



Codice	C mt	B mm	gr	☒	Barcode
601006	3	16	156	10	8033116549806
601007	5	19	251	10	8033116549813
601008	8	25	292	10	8033116549820
601009	5	25	440	10	8033183551375



601106 FLESSOMETRO DOPPIO IN ABS MAGNETIC FLEXOMETER IN ABS

- Custodia in ABS con rivestimento in gomma antiscivolo
ABS case with non-slip rubber coating
- Nastro con doppia laccatura per una maggiore resistenza
Double lacquered tape for added strength
- Doppia graduazione (fronte orizzontale e retro verticale)
Double graduation (front horizontal and rear vertical)



Codice	C mt	B mm	gr	☒	Barcode
601106	3	19	156	10	8033183589149
601108	8	25	440	10	8033183589163
601109	5	28	230	10	8033183589156



601406 FLESSOMETRO BICOMPONENTE IN ABS BI-COMPONENT FLEXOMETER IN ABS

- Custodia in ABS con rivestimento in gomma antiscivolo
ABS case with non-slip rubber coating



Codice	C mt	B mm	gr	☒	Barcode
601406	3	19	156	10	8033183560308
601407	5	19	251	10	8033183558633
601408	8	25	440	10	8033183561145
601409	5	25	292	10	8033183561411
601410	10	25	514	10	8033183561152





601502 FLESSOMETRO COMPATTO COMPACT FLEXOMETER

- Custodia compatta
Compact case
- Nastro in nylon brillante
Shiny nylon ribbon
- Sistema di bloccaggio a rilascio immediato automatico
Automatic immediate release locking system

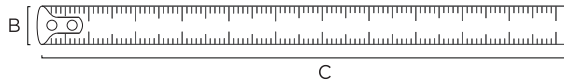

Codice	C mt	B mm		Barcode
601502	2	13	10	8033183846068
601503	3	16	10	8033183846075
601504	5	19	10	8033183846082
601505	5	25	10	8033183846099
601506	8	25	10	8033183846105

601507 FLESSOMETRO ANTIRIFLESSO ANTI-REFLEX FLEXOMETER

- Custodia compatta e struttura robusta
Compact housing and sturdy construction
- Nastro in nylon antiusura e antiriflesso
Anti-wear and anti-reflective nylon tape
- Sistema di bloccaggio a rilascio immediato automatico
Automatic immediate release locking system

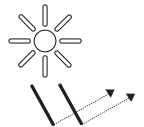
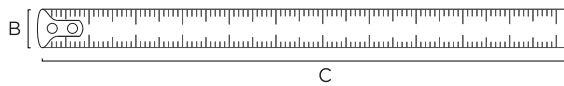

Codice	C mt	B mm		Barcode
601507	5	28	10	8033183846112
601508	8	28	10	8033183846129

601509 FLESSOMETRO ANTIRIFLESSO ANTI-REFLEX FLEXOMETER

- Custodia compatta in bicomponente antiscivolo
Compact two-component non-slip case
- Nastro in nylon antiusura e antiriflesso
Anti-wear and anti-reflective nylon tape
- Sistema di bloccaggio a rilascio immediato automatico
Automatic immediate release locking system

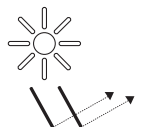
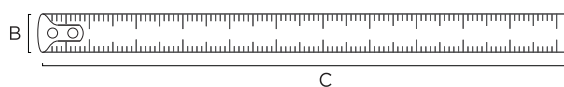

Codice	C mt	B mm		Barcode
601509	5	25	10	8033183846136
601510	10	30	10	8033183846143

601011 MISURATORE AD ULTRASUONI ULTRASOUND METER

- Metro manuale da 5 mt con riavvolgimento automatico del nastro
5m manual tape measure with automatic rewinding of the tape
- Range di misurazione: 0,45 - 18 mt
Measurement range: 0.45 - 18 mt
- Alimentazione: batteria 9v
Power supply: 9v battery
- Compensazione temperatura: 0°C - 38°
Temperature compensation: 0 °C - 38 °
- Energia trasmissione laser: < 1 mw
Laser transmission energy: <1 mw



Codice			Barcode
601011		6	8033183579959

602001 ROTELLA METRICA NASTRO IN FIBRA METRIC WHEEL FIBER TAPE

- Custodia in ABS rivestita e fettuccia in fibra di vetro
ABS coated case and fiberglass webbing
- Riavvolgimento manuale
Automatic immediate release locking system
- Doppia graduazione
Double graduation

Codice	mt	gr		Barcode
602001	20	400	5	8033116549868
602002	10	350	5	8033183558411
602003	30	450	5	8033183590251
602004	50	550	5	8033183590268



602005 ROTELLA METRICA NASTRO ACCIAIO STEEL TAPE METRIC WHEEL

- Custodia in ABS rivestita e fettuccia in acciaio antirottura
ABS coated case and fiberglass webbing
- Riavvolgimento manuale
Automatic immediate release locking system

Codice	mt		Barcode
602005	20	5	8033183846181
602006	30	5	8033183846167
602007	50	5	8033183846174



602102 ROTELLA METRICA NASTRO FIBRA FIBER TAPE METRIC WHEEL

- Custodia in ABS aperta e fettuccia in fibra
Open ABS case and fiber webbing
- Con impugnatura
With handle

Codice	mt	gr		Barcode
602102	50	800	5	8033183846150



602103 ROTELLA METRICA NASTRO FIBRA
FIBER TAPE METRIC WHEEL

- Custodia in bicomponente e fettuccia in fibra
Bi-component case and fiber webbing
- Riavvolgimento rapido a 4 velocità
4 speed fast rewind
- Impugnatura ergonomica
Ergonomic handle

Codice	mt	gr		Barcode
602103	50	730	5	8033183846198



602101 ROTELLA METRICA NASTRO ACCIAIO
STEEL TAPE METRIC WHEEL

- Custodia in bicomponente e fettuccia in acciaio
Bi-component case and steel tape
- Riavvolgimento rapido a 4 velocità
4 speed fast rewind
- Impugnatura ergonomica
Ergonomic handle

Codice	mt	gr		Barcode
602101	50	800	5	8033116549851



601004E ESPOSITORE 24 MINI METRI CON PORTACHIAVI
24 SMALL TAPE MEASURES DISPLAY WITH KEY RING

- Corpo in plastica
Plastic body
- Nastro estensibile e retrattile
Extendable and retractable tape
- Tascabile con anello portachiavi
Pocket with key ring

Codice	gr		Barcode
601004E 24 x 601406 (1 mt x 6 mm)	800	1	8033183556950



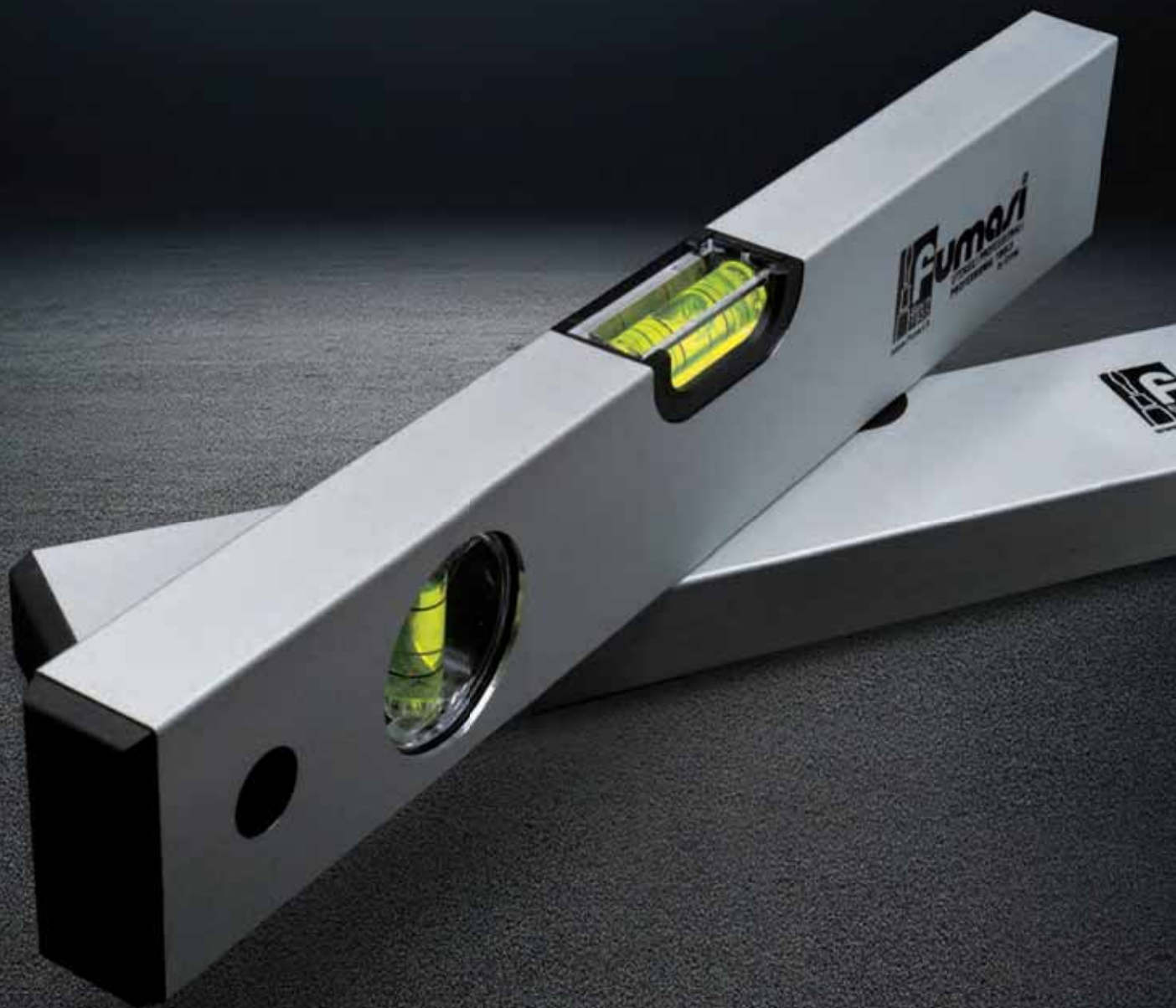

LINEA PRO
PRO LINE



MAGNETICO
MAGNETIC

244 Livelle
Levels

Livelle

Levels

603000P LIVELLA PROFESSIONALE A 2 FIALE PROFESSIONAL 2 VIAL LEVEL



- Profilo in alluminio anodizzato da 2 mm che garantisce robustezza al prodotto
2 mm anodized aluminum profile that guarantees robustness to the product
- Bordi stondati in plastica
Rounded edges in plastic
- Precisione dei piani di lavoro: +/- 0,5 mm/m
Accuracy of the work surfaces: +/- 0.5 mm / m
- 2 fiale antiurto
2 shockproof vials



Codice	mm	gr		Barcode
603000P	300	215	5	8033183588890
603002P	400	265	5	8033183588906
603050P	500	340	5	8033183588913
603060P	600	390	5	8033183589101
603080P	800	560	5	8033183588937
603010P	1000	650	5	8033183588944
603012P	1200	730	5	8033183588951

Versione magnetica Magnetic version



Codice		mm	gr		Barcode	
603100P	Magnetica / Magnetic		300	256	5	8033183588968
603104P	Magnetica / Magnetic		400	340	5	8033183588975
603105P	Magnetica / Magnetic		500	377	5	8033183588982
603106P	Magnetica / Magnetic		600	418	5	8033183588999
603108P	Magnetica / Magnetic		800	532	5	8033183589002
603110P	Magnetica / Magnetic		1000	618	5	8033183589019
603112P	Magnetica / Magnetic		1200	701	5	8033183589026

603204P LIVELLA RINFORZATA REINFORCED LEVEL



- Profilo in alluminio maggiorato e rinforzato all'interno
Aluminum profile increased and reinforced inside
- Tappi antishock in bicomponente
Bi-component anti-shock plugs
- Precisione dei piani di lavoro: +/- 0,5 mm/m
Accuracy of the work surfaces: +/- 0.5 mm / m
- 3 fiale antiurto
3 shockproof vials



Codice	mm	gr		Barcode
603204P	400	380	5	8033183589033
603205P	500	470	5	8033183589040

603206P LIVELLA RINFORZATA REINFORCED LEVEL



- Profilo in alluminio maggiorato e rinforzato all'interno
Aluminum profile increased and reinforced inside
- Tappi antishock in bicomponente
Bi-component anti-shock plugs
- Doppia impugnatura ergonomica
Double ergonomic handle
- Precisione dei piani di lavoro: +/- 0,5 mm/m
Accuracy of the work surfaces: +/- 0.5 mm / m
- 3 fiale antiurto
3 shockproof vials



Codice	mm	gr		Barcode
603206P	600	550	5	8033183589057
603208P	800	700	5	8033183589064
603210P	1000	840	5	8033183589071
603212P	1200	1020	5	8033183589088

603310P LIVELLA PER IDRAULICI LEVEL FOR HYDRAULICS



- Profilo in alluminio anodizzato e protezione anti-shock
Anodized aluminum profile and anti-shock protection
- Posizionamento possibile con vari interassi a lettura facilitata
Possible positioning with various easy-to-read center distances
- 2 perni attacco 3/8" e 1/2" dotati di bolla utilizzabili singolarmente
2 pins 3/8" and 1/2" equipped with bubble that can be used individually
- 3 fiale antiurto
3 shockproof vials
- Fornita in custodia PVC
Supplied in PVC case



Codice	mm	gr		Barcode
603310P	300	495	5	8033183589118

603001 LIVELLA STANDARD A 2 FIALE STANDARD 2 VIAL LEVEL

- Profilato in alluminio
Aluminum profile
- Base millimetrata serigrafata
Screen-printed millimeter base
- 2 fiale antiurto
2 shockproof vials



Codice	mm	gr		Barcode
603001	400	210	5	8033116531313
603002	600	260	5	8033116549905
603030	300	230	5	8033183554482
603050	500	200	5	8033183554840
603080	800	250	5	8033183554697

603104 LIVELLA BASIC A 3 FIALE 3 VIAL LEVEL BASIC MODEL

- Profilato in alluminio
Aluminum profile
- 3 fiale antiurto
2 shockproof vials



Codice	mm	gr		Barcode
603104	400	300	5	8033183554345
603105	500	320	5	8033183554352
603106	600	400	5	8033183554369
603108	800	500	5	8033183554376
603110	1000	600	5	8033183554383

Versione magnetica
Magnetic version



Codice		mm	gr		Barcode	
603204	Magnetica / <i>Magnetic</i>		400	450	5	8033183554284
603205	Magnetica / <i>Magnetic</i>		500	500	5	8033183554291
603206	Magnetica / <i>Magnetic</i>		600	600	5	8033183554307
603208	Magnetica / <i>Magnetic</i>		800	700	3	8033183554314
603210	Magnetica / <i>Magnetic</i>		1000	950	3	8033183554321

603000 LIVELLA TASCABILE POCKET LEVEL

- Corpo in plastica
Plastic body
- 2 fiale antiurto
2 shockproof vials



Codice	mm	gr		Barcode
603000	105	20	10	8033116549882

603003 LIVELLA HOBBY MAGNETICA MAGNETIC HOBBY LEVEL

- Corpo in ABS
ABS body
- 3 fiale antiurto
3 shockproof vials



Codice	mm	gr		Barcode
603003	220	108	10	8033116549899

LAVORAZIONE PRECISA ED EFFICIENTE

PRECISE AND EFFICIENT WORKING



LINEA PRO
PRO LINE



PER METALLI
FOR METALS



PER ACCIAIO
FOR STEEL



PER ACCIAIO INOX
FOR STAINLESS STEEL



PER MURO
FOR WALL



PER PIETRA
FOR STONE



PER PIASTRELLE
FOR TILES



PER MARMO
FOR MARBLE



PER LEGNO
FOR WOOD



PER PLASTICA
FOR PLASTIC



ACCIAIO HSS
HSS STEEL



ACCIAIO HSS-G
HSS-G STEEL



METALLO DURO
HARD METAL



MISURE ATTACCHI IN POLLICI
ATTACHMENT MEASURES (INCHES)



ATTACCO SDS PLUS
SHANK SDS PLUS

248 Punta per metalli
Tips for metals

250 Punta per materiali edili
Tips for building materials

253 Punta per trapani
Drill bits

256 Foratura metallo
Metal drilling

262 Utensili a filettare
Threading tools

Punte per metalli

Tips for metals

270000 PUNTE ELICOIDALI HSS HSS TWIST DRILLS

- Punta HSS con esecuzione rullata
HSS drill with rolled execution
- Affilatura a 118°
118° sharpening
- $R \leq 650 \text{ n/mm}^2$
 $R \leq 650 \text{ n/mm}^2$
- Serie corta
Short series

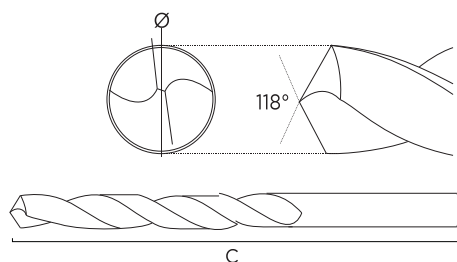

Codice	Ø mm	c mm	gr		Barcode
270000	1,0	32	5	10	8033183569271
270001	1,5	40	5	10	8033116549929
270002	2,0	50	10	10	8033116531894
270003	2,5	55	18	10	8033116531870
270004	3,0	60	25	10	8033116531887
270005	3,5	70	35	10	8033116531900
270006	4,0	75	55	10	8033116531917
270007	4,5	80	72	10	8033116549912
270008	5,0	85	95	10	8033116549936
270009	5,5	90	125	10	8033116549943
270010	6,0	95	137	10	8033116531924
270011	6,5	95	180	10	8033116549950

Codice	Ø mm	c mm	gr		Barcode
270012	7,0	100	225	10	8033116549967
270013	7,5	100	260	10	8033116549974
270014	8,0	115	325	10	8033116531931
270015	8,5	115	360	10	8033116549981
270016	9,0	120	435	10	8033116540001
270017	10,0	130	550	10	8033116532129
270018	11,0	140	700	10	8033116550064
270019	12,0	145	880	10	8033116550071
270020	13,0	150	1040	10	8033116550088
270021	14,0	160	1200	5	8033116561442
270022	15,0	170	1450	5	8033116561459

271001 ASSORTIMENTO PUNTE ELICOIDALI HSS HSS TWIST DRILLS SET

Codice	Pezzi / Pieces	Ø mm		Barcode
271001	13	1,5 - 2 - 2,5 - 3 - 3,3 - 3,5 - 4 - 4,2 - 4,5 - 5 - 5,5 - 6 - 6,5	5	8033183550095
272001	19	1 - 1,5 - 2 - 2,5 - 3 - 3,5 - 4 - 4,5 - 5 - 5,5 - 6 - 6,5 - 7 - 7,5 - 8 - 8,5 - 9 - 9,5 - 10	3	8033116531245
273010	26	1 - 1,5 - 2 - 2,5 - 3 - 3,3 - 3,5 - 4 - 4,5 - 5 - 5,5 - 6 - 6,5 - 7 - 7,5 - 8 - 8,5 - 9 - 9,5 - 10 - 10,5 - 11 - 11,5 - 12 - 12,5 - 13	3	8033183557018



270004L PUNTE ELICOIDALI PROLUNGATE EXTENDED TWIST DRILLS

- ♦ Punta HSS con esecuzione rullata
HSS drill with rolled execution
- ♦ Affilatura a 118°
118° sharpening
- ♦ $R \leq 650 \text{ n/mm}^2$
 $R \leq 650 \text{ n/mm}^2$
- ♦ Serie lunga
Long series

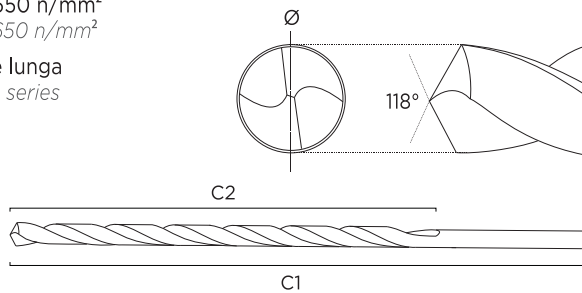

Codice	Ø mm	C1 mm	C2 mm	Icon	Barcode
270004L	3,0	100	66	10	8033183584595
270005L	3,5	112	73	10	8033183584601
270006L	4,0	119	78	10	8033183584618
270007L	4,5	126	82	10	8033183584625
270008L	5,0	132	87	10	8033183584632
270009L	5,5	139	91	10	8033183584649
270010L	6,0	139	91	10	8033183584656
270011L	6,5	148	97	10	8033183584663

Codice	Ø mm	C1 mm	C2 mm	Icon	Barcode
270012L	7,0	156	102	10	8033183584670
270013L	7,5	156	102	10	8033183584687
270014L	8,0	165	109	10	8033183584694
270015L	8,5	165	109	10	8033183584700
270016L	9,0	175	115	10	8033183584717
270017L	10,0	184	121	10	8033183584724
270018L	11,0	195	128	10	8033183584731
270019L	12,0	205	134	10	8033183584748

270000C PUNTE ELICOIDALI HSS AL COBALTO 5% 5% COBALT HSS TWIST DRILLS

- ♦ Esecuzione interamente rettificata
Fully ground execution
- ♦ Affilatura a 130°
130° sharpening
- ♦ $R \leq 1200 \text{ n/mm}^2$
 $R \leq 1200 \text{ n/mm}^2$
- ♦ Serie corta
Short series

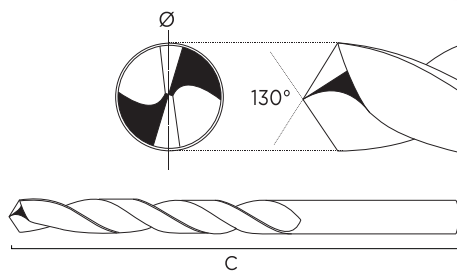

SPLIT POINT



Codice	Ø mm	C mm	gr	Icon	Barcode
270000C	1,0	40	5	10	8033183569288
270001C	1,5	40	5	10	8033183558855
270002C	2,0	49	10	10	8033183560872
270003C	2,5	57	18	10	8033183560841
270004C	3,0	61	25	10	8033183557520
270005C	3,5	70	35	10	8033183557490
270006C	4,0	75	55	10	8033183557544
270007C	4,5	80	72	10	8033183557513
270008C	5,0	86	95	10	8033183557537
270009C	5,5	93	125	10	8033183557506
270010C	6,0	93	137	10	8033183557483

Codice	Ø mm	C mm	gr	Icon	Barcode
270011C	6,5	101	180	10	8033183560858
270012C	7,0	109	225	10	8033183561466
270013C	7,5	109	260	10	8033183561503
270014C	8,0	117	325	10	8033183558480
270015C	8,5	117	360	10	8033183558497
270016C	9,0	125	435	10	8033183552877
270017C	10,0	133	550	10	8033183558503
270018C	11,0	142	700	10	8033183569295
270019C	12,0	151	880	10	8033183558510
270020C	13,0	151	1040	10	8033183560865

272001C ASSORTIMENTO PUNTE HSS AL COBALTO 5%
HSS COBALT 5% DRILLS SET

Codice	Pezzi / pieces	Ø mm		Barcode
272001C	19	1 - 1,5 - 2 - 2,5 - 3 - 3,5 - 4 - 4,5 - 5 - 5,5 - 6 - 6,5 - 7 - 7,5 - 8 - 8,5 - 9 - 10 - 11	1	8033183561039



Punte per materiali edili

Tips for building materials

275001 PUNTE ELICOIDALI PER MATERIALI EDILI
TWIST DRILLS FOR BUILDING MATERIALS

- Affilatura a 130°
130° sharpening
- Serie corta
Short series

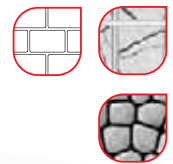
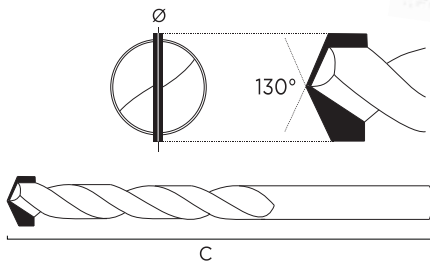

Codice	Ø mm	C mm	gr		Barcode
275001	3,0	70	4	10	8033183550101
275002	4,0	75	6	10	8033183550118
275003	5,0	85	11	10	8033183550125
275004	6,0	100	15	10	8033183550132
275005	7,0	100	21	10	8033183550149
275006	8,0	120	26	10	8033183550156
275007	9,0	120	30	10	8033183550163
275008	10,0	120	46	10	8033183550170
275009	11,0	150	77	10	8033183550187
275010	12,0	150	80	10	8033183550194
275011	13,0	150	100	10	8033183550200
275012	14,0	150	110	10	8033183550217

Codice	Ø mm	C mm	gr		Barcode
275013	15,0	150	125	10	8033183550224
275014	16,0	150	150	10	8033183550231
275015	18,0	160	180	10	8033183550248
275016	20,0	160	230	10	8033183550255
275017	22,0	160	-	5	8033183563613
275018	24,0	160	-	5	8033183563620
275019	25,0	160	-	5	8033183563637
275020	26,0	160	-	5	8033183566911
275021	28,0	160	-	5	8033183566904
275022	30,0	160	-	5	8033183566898
275023	32,0	160	-	5	8033183566881

277001 ASSORTIMENTO PUNTE ELICOIDALI PER MATERIALI EDILI
TWIST DRILLS SET FOR BUILDING MATERIALS

Codice	Pezzi / pieces	Ø mm		Barcode
277001	7	3 - 4 - 5 - 6 - 8 - 9 - 10	1	8033183550279
277801	4	4 - 5 - 6 - 8	1	8033183552228



27500L PUNTE ELICOIDALI PROLUNGATE PER MATERIALI EDILI EXTENDED TWIST DRILLS FOR BUILDING MATERIALS

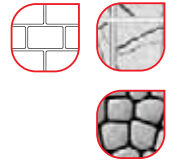

- Affilatura a 130°
130° sharpening
- Serie lunga
Long series

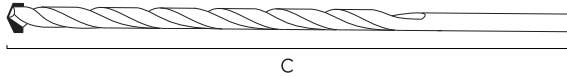
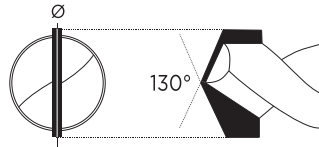

Codice	Ø mm	C mm		Barcode
275004LL	6,0	300	10	8033183585233
275004XL	6,0	400	10	8033183585301
275006L	8,0	200	10	8033183584762
275006LL	8,0	300	10	8033183585240
275006XL	8,0	400	10	8033183585066
275007L	9,0	200	10	8033183585189
275007LL	9,0	300	10	8033183585257
275007XL	9,0	400	10	8033183585318
275008L	10,0	200	10	8033183585196
275008LL	10,0	300	10	8033183584878
275008XL	10,0	400	10	8033183585325
275009XL	11,0	400	10	8033183585332
275010L	12,0	200	10	8033183585202
275010LL	12,0	300	10	8033183585264
275010XL	12,0	400	10	8033183585349
275011L	13,0	200	10	8033183584809

Codice	Ø mm	C mm		Barcode
275011LL	13,0	300	10	8033183584892
275011XL	13,0	400	10	8033183585356
275012L	14,0	200	10	8033183585219
275012LL	14,0	300	10	8033183585271
275012XL	14,0	400	10	8033183585363
275013XL	15,0	400	10	8033183584991
275014L	16,0	200	10	8033183584823
275014LL	16,0	300	10	8033183584915
275014XL	16,0	400	10	8033183585004
275015L	18,0	200	10	8033183584847
275015LL	18,0	300	10	8033183585288
275015XL	18,0	400	10	8033183585370
275016L	20,0	200	10	8033183585226
275016LL	20,0	300	10	8033183585295
275016XL	20,0	400	10	8033183585028

275006G PUNTE SUPERIOR A ROTOPERCUSIONE SUPERIOR ROTARY PERCUSSION TIPS

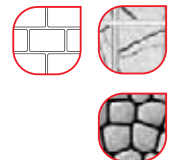

- Affilatura a 130°
130° sharpening
- Serie corta
Short series

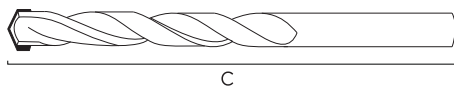
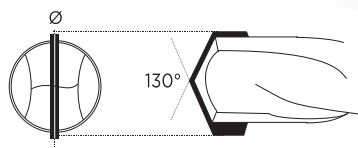

Codice	Ø mm	C mm		Barcode
275006G	15,0	120	10	8033183585073
275007G	16,0	120	10	8033183585080
275008G	18,0	120	10	8033183585097
275009G	20,0	120	10	8033183585103
275010G	22,0	145	10	8033183585110
275011G	24,0	145	10	8033183585127

Codice	Ø mm	C mm		Barcode
275012G	25,0	145	10	8033183585134
275013G	26,0	145	10	8033183585141
275014G	28,0	150	10	8033183585158
275015G	30,0	150	10	8033183585165
275016G	32,0	150	10	8033183585172

277001G ASSORTIMENTO PUNTE SUPERIOR A ROTOPERCUSSIONE
SUPERIOR ROTARY PERCUSSION DRILLS SET

Codice	Pezzi / Pieces	Ø mm		Barcode
277001G	8	3 - 4 - 5 - 6 - 8 - 9 - 10 - 12	1	8033183585387
277801G	5	4 - 5 - 6 - 8 - 10	1	8033183585394



2700CE PUNTE UNIVERSALI AD ALTE PRESTAZIONI
HIGH PERFORMANCE UNIVERSAL TIPS

- Placchetta in metallo duro a grana ultrafine, affilata e rettificata più volte al diamante, con geometria innovativa ed unita al corpo con saldobrasatura ad alte temperature
Ultra-fine grain hard metal plate sharpened and ground more times to the diamond with innovative geometry and joined to the body with brazing at high temperatures
- Corpo maggiorato in acciaio legato per una maggiore resistenza
Oversized body in alloy steel for greater resistance
- Punta attiva per un ottimo centraggio in fase iniziale di taglio
Active tip for excellent centering in the initial cutting phase
- Il design a 4 spirali dell'elica fortemente inclinata assicura un elevato avanzamento nella foratura in qualsiasi materiale
The 4-spiral design of the strongly inclined flute ensures a high advancement in drilling in any material

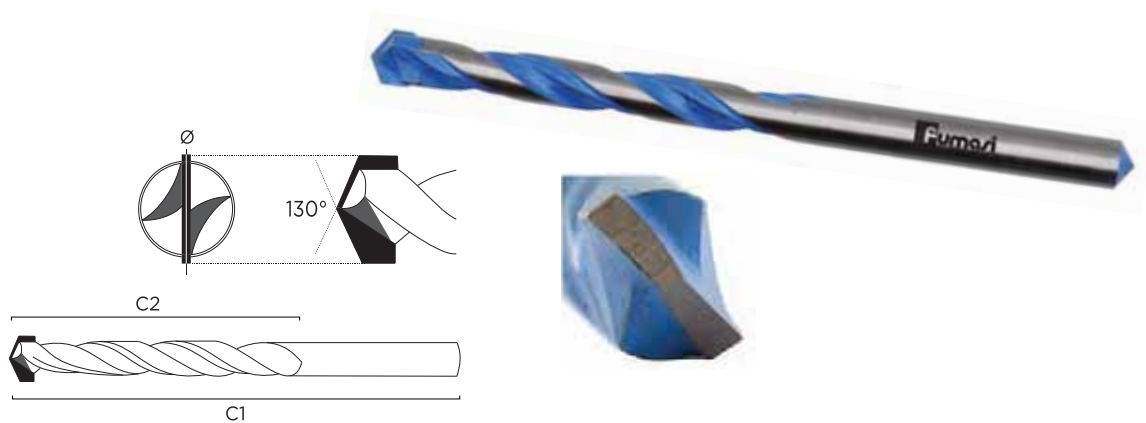
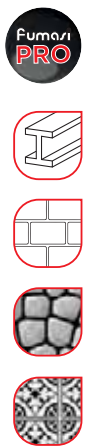

Codice	Ø mm	C1 mm	C2 mm		Barcode
270003CE	3,0	70	40	10	8033183589439
270004CE	4,0	75	40	10	8033183589446
270005CE	5,0	85	50	10	8033183589453
270006CE	5,0	150	90	10	8033183589477
270007CE	5,5	85	50	10	8033183589507
270008CE	6,0	100	60	10	8033183589514
270009CE	6,0	150	90	10	8033183589552
270010CE	6,5	100	60	10	8033183589569
270011CE	7,0	100	60	10	8033183589606
270013CE	8,0	120	80	10	8033183589613
270014CE	8,0	150	90	5	8033183589644
270015CE	8,0	250	200	5	8033183589576
270016CE	8,0	400	350	5	8033183589668

Codice	Ø mm	C1 mm	C2 mm		Barcode
270017CE	9,0	120	80	5	8033183589583
270018CE	10,0	120	80	5	8033183589590
270019CE	10,0	150	90	5	8033183589620
270020CE	10,0	250	200	5	8033183589637
270021CE	10,0	400	350	5	8033183589651
270055CE	11,0	150	90	5	8033183589460
270056CE	12,0	150	90	5	8033183589675
270065CE	12,0	250	200	5	8033183589484
270066CE	12,0	400	350	5	8033183589491
270085CE	14,0	200	150	5	8033183589521
270086CE	14,0	250	200	5	8033183589538
270087CE	16,0	200	150	5	8033183589545

Punte per trapani SDS-PLUS

SDS-PLUS drill bits

270501 PUNTE ATTACCO SDS PLUS STANDARD STANDARD SDS PLUS DRILL BITS

- Placchetta in metallo duro per una lunga durata e un'alta resistenza
Carbide bit for long life and high strength
- 2 taglienti e 4 eliche maggiorate
2 cutting edges and 4 oversized flute
- Con puntina di centraggio
Centering pin
- Adatte per tutti i martelli SDS-PLUS
Suitable for all SDS-PLUS hammers

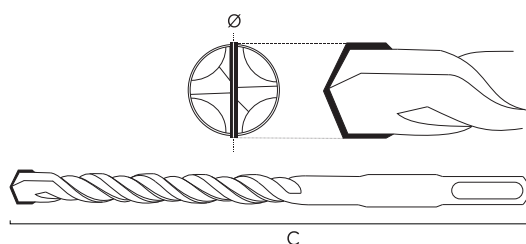

Codice		Ø mm	C mm		Barcode
270501	SDS plus / SDS plus	5,0	110	10	8033183559456
270505L	SDS plus / SDS plus	5,0	460	10	8033183581358
270502	SDS plus / SDS plus	6,0	110	10	8033183557995
270504	SDS plus / SDS plus	6,0	160	10	8033183558022
270502L	SDS plus / SDS plus	6,0	260	10	8033183581334
270503	SDS plus / SDS plus	8,0	110	10	8033183558008
270505	SDS plus / SDS plus	8,0	160	10	8033183557971
270503L	SDS plus / SDS plus	8,0	260	10	8033183581341
270506L	SDS plus / SDS plus	10,0	110	10	8033183581372
270506	SDS plus / SDS plus	10,0	160	10	8033183558015
270506LL	SDS plus / SDS plus	10,0	260	10	8033183581365
270507	SDS plus / SDS plus	10,0	460	10	8033183559470
270507L	SDS plus / SDS plus	10,0	610	10	8033183580993

Codice		Ø mm	C mm		Barcode
270508	SDS plus / SDS plus	12,0	160	10	8033183557988
270508L	SDS plus / SDS plus	12,0	260	10	8033183581389
270509	SDS plus / SDS plus	12,0	460	10	8033183559463
270509L	SDS plus / SDS plus	12,0	600	10	8033183580979
270514C	SDS plus / SDS plus	14,0	210	5	8033183558077
270514	SDS plus / SDS plus	14,0	310	5	8033183558299
270514L	SDS plus / SDS plus	14,0	460	5	8033183569301
270516L	SDS plus / SDS plus	16,0	450	5	8033183569325
270516LL	SDS plus / SDS plus	16,0	600	5	8033183580986
270517	SDS plus / SDS plus	18,0	250	5	8033183569332
270518	SDS plus / SDS plus	20,0	250	5	8033183569349
270519	SDS plus / SDS plus	20,0	450	5	8033183569356

270513 ASSORTIMENTO PUNTE ATTACCO SDS PLUS STANDARD STANDARD SDS PLUS DRILL SET

Codice	Pezzi / Pieces			Barcode
270513	7	5 - 6 - 8 (x 110 mm) 6 - 8 - 10 - 12 (x 160 mm)	1	8033183559821



2750H PUNTE ATTACCO SDS PLUS HAMMER SDS PLUS HAMMER DRILL BITS



- Placchetta integrale a 4 taglienti in metallo duro, legata al corpo con saldatura **elettronica per diffusione**: garantisce un legame molto stabile tra placchetta e corpo

Integral 4-flute hard metal plate bonded to the body with electronic diffusion soldering: guarantees a very strong bond stable between plate and body

- Ogni tagliente ha un proprio scarico per i detriti
Each cutting edge has its own debris drain
- Corpo fresato con scanalatura a "L" ad alta evacuazione
Large milled flute type "L" for a faster dust removal
- 3 placchette che variano all'aumentare del diametro della punta:
3 plates that vary as the tip diameter increases:

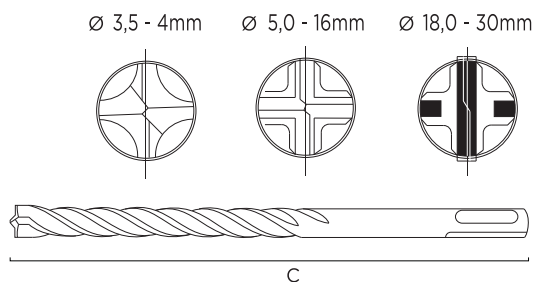

Codice		Ø mm	C mm		Barcode
275035H	SDS plus /SDS plus	3,5	115	10	8033183843517
275035HL	SDS plus /SDS plus	3,5	165	10	8033183843524
275040H	SDS plus /SDS plus	4,0	115	10	8033183843531
275040HL	SDS plus /SDS plus	4,0	165	10	8033183843548
275050H	SDS plus /SDS plus	5,0	115	10	8033183843562
275050HL	SDS plus /SDS plus	5,0	165	10	8033183843555
275050HLL	SDS plus /SDS plus	5,0	215	10	8033183843579
275050HLLLL	SDS plus /SDS plus	5,0	265	10	8033183843586
275050HLLLLL	SDS plus /SDS plus	5,0	315	10	8033183844194
275050HLE	SDS plus /SDS plus	5,0	465	10	8033183844521
275055H	SDS plus /SDS plus	5,5	115	10	8033183844200
275055HL	SDS plus /SDS plus	5,5	165	10	8033183844217
275055HLL	SDS plus /SDS plus	5,5	215	10	8033183844231
275055HLLL	SDS plus /SDS plus	5,5	265	10	8033183844248
275055HLLLL	SDS plus /SDS plus	5,5	315	10	8033183844255
275055HLE	SDS plus /SDS plus	5,5	465	10	8033183844224
275060H	SDS plus /SDS plus	6,0	115	10	8033183844262
275060HL	SDS plus /SDS plus	6,0	165	10	8033183844286
275060HLL	SDS plus /SDS plus	6,0	215	10	8033183844309
275060HLLL	SDS plus /SDS plus	6,0	265	10	8033183844316
275060HLLLL	SDS plus /SDS plus	6,0	315	10	8033183846570
275060HLE	SDS plus /SDS plus	6,0	465	10	8033183844293
275065H	SDS plus /SDS plus	6,5	115	10	8033183844323
275065HL	SDS plus /SDS plus	6,5	165	10	8033183844330
275065HLL	SDS plus /SDS plus	6,5	215	10	8033183844347
275065HLLL	SDS plus /SDS plus	6,5	265	10	8033183844354
275065HLLLL	SDS plus /SDS plus	6,5	315	10	8033183844361
275070H	SDS plus /SDS plus	7,0	115	10	8033183844378
275070HL	SDS plus /SDS plus	7,0	165	10	8033183844385
275070HLL	SDS plus /SDS plus	7,0	215	10	8033183844392
275070HLLL	SDS plus /SDS plus	7,0	265	10	8033183844408
275080H	SDS plus /SDS plus	8,0	115	10	8033183844415
275080HL	SDS plus /SDS plus	8,0	165	10	8033183844422
275080HLL	SDS plus /SDS plus	8,0	215	10	8033183844446
275080HLLL	SDS plus /SDS plus	8,0	265	10	8033183844453

Codice		Ø mm	C mm		Barcode
275080HLLLLL	SDS plus /SDS plus	8,0	315	10	8033183844460
275080HLLLLLL	SDS plus /SDS plus	8,0	365	10	8033183844477
275080HLE	SDS plus /SDS plus	8,0	465	10	8033183844439
275090H	SDS plus /SDS plus	9,0	115	10	8033183844484
275090HLL	SDS plus /SDS plus	9,0	215	10	8033183844507
275010H	SDS plus /SDS plus	10,0	115	10	8033183843593
275010HL	SDS plus /SDS plus	10,0	165	10	8033183843609
275010HLL	SDS plus /SDS plus	10,0	215	10	8033183843623
275010HLLL	SDS plus /SDS plus	10,0	265	10	8033183843654
275010HLLLL	SDS plus /SDS plus	10,0	315	10	8033183843661
275010HLLLLLL	SDS plus /SDS plus	10,0	365	10	8033183846587
275010HLE	SDS plus /SDS plus	10,0	465	10	8033183843616
275010HLLLE	SDS plus /SDS plus	10,0	600	10	8033183843630
275010HLLLE	SDS plus /SDS plus	10,0	1000	10	8033183843647
275011HL	SDS plus /SDS plus	11,0	165	10	8033183843685
275011HLL	SDS plus /SDS plus	11,0	215	10	8033183843692
275011HLLL	SDS plus /SDS plus	11,0	265	10	8033183843708
275012HL	SDS plus /SDS plus	12,0	165	10	8033183843715
275012HLL	SDS plus /SDS plus	12,0	215	10	8033183843739
275012HLLL	SDS plus /SDS plus	12,0	265	10	8033183843760
275012HLLLL	SDS plus /SDS plus	12,0	315	10	8033183843777
275012HLLLLLL	SDS plus /SDS plus	12,0	365	10	8033183843784
275012HLE	SDS plus /SDS plus	12,0	465	10	8033183843722
275012HLLLE	SDS plus /SDS plus	12,0	600	10	8033183843746
275012HLLLE	SDS plus /SDS plus	12,0	1000	10	8033183843753
275013HL	SDS plus /SDS plus	13,0	165	10	8033183843791
275013HLL	SDS plus /SDS plus	13,0	215	10	8033183843807
275013HLLL	SDS plus /SDS plus	13,0	265	10	8033183843814
275014HL	SDS plus /SDS plus	14,0	165	10	8033183843821
275014HLL	SDS plus /SDS plus	14,0	215	10	8033183843845
275014HLLL	SDS plus /SDS plus	14,0	265	10	8033183843876
275014HLLLL	SDS plus /SDS plus	14,0	315	10	8033183843883
275014HLLLLL	SDS plus /SDS plus	14,0	365	10	8033183843890
275014HLE	SDS plus /SDS plus	14,0	465	10	8033183843838
275014HLLLE	SDS plus /SDS plus	14,0	600	10	8033183843852

Codice		Ø mm	C mm		Barcode
275014HLLLE	SDS plus /SDS plus	14,0	1000	10	8033183843869
275015HL	SDS plus /SDS plus	15,0	165	10	8033183843906
275015HLLLL	SDS plus /SDS plus	15,0	265	10	8033183843920
275015HLE	SDS plus /SDS plus	15,0	465	10	8033183843913
275016HLL	SDS plus /SDS plus	16,0	215	10	8033183843944
275016HLLLL	SDS plus /SDS plus	16,0	265	10	8033183843975
275016HLLLLL	SDS plus /SDS plus	16,0	315	10	8033183843982
275016HLE	SDS plus /SDS plus	16,0	465	10	8033183843937
275016HLLLE	SDS plus /SDS plus	16,0	600	10	8033183843951
275016HLLLE	SDS plus /SDS plus	16,0	1000	10	8033183843968
275017HLL	SDS plus /SDS plus	17,0	215	10	8033183843999
275017HLLLL	SDS plus /SDS plus	17,0	315	10	8033183844002
275018HLL	SDS plus /SDS plus	18,0	250	10	8033183844026
275018HLLLLL	SDS plus /SDS plus	18,0	450	10	8033183844040
275018HLLLE	SDS plus /SDS plus	18,0	600	10	8033183844019

Codice		Ø mm	C mm		Barcode
275018HLLLE	SDS plus /SDS plus	18,0	1000	10	8033183844033
275020HLLL	SDS plus /SDS plus	20,0	250	10	8033183844064
275020HLLLLL	SDS plus /SDS plus	20,0	450	10	8033183844088
275020HLLLE	SDS plus /SDS plus	20,0	600	10	8033183844057
275020HLLLE	SDS plus /SDS plus	20,0	1000	10	8033183844071
275022HLLL	SDS plus /SDS plus	22,0	250	10	8033183844101
275022HLLLLL	SDS plus /SDS plus	22,0	450	10	8033183844125
275022HLLLE	SDS plus /SDS plus	22,0	600	10	8033183844095
275022HLLLE	SDS plus /SDS plus	22,0	1000	10	8033183844118
275024HLLLLL	SDS plus /SDS plus	24,0	450	10	8033183844132
275025HLLLLL	SDS plus /SDS plus	25,0	450	10	8033183844163
275025HLLLE	SDS plus /SDS plus	25,0	600	10	8033183844149
275025HLLLE	SDS plus /SDS plus	25,0	1000	10	8033183844156
275028HLLLLL	SDS plus /SDS plus	28,0	450	10	8033183844170
275030HLLLLL	SDS plus /SDS plus	30,0	450	10	8033183844187

275030P PUNTE ATTACCO SDS PLUS 4x4 SDS PLUS 4x4 DRILL BITS

- Testa in metallo duro integrale, legata al corpo con saldatura **elettronica per diffusione**: garantisce un legame molto stabile tra placchetta e corpo
Solid carbide head bonded to the body with welding diffusion electronics: guarantees a very stable link between plate and body
- Punta a 4 taglienti i quali creano un foro cilindrico e preciso
Point with 4 cutting edges which create a cylindrical and precise hole
- Ogni tagliente ha un proprio scarico per i detriti
Each cutting edge has its own debris drain
- Le 4 eliche, come i taglienti, garantiscono un taglio ad alto rendimento
The 4 flutes, like the cutting edges, guarantee a high-performance cut
- La trasmissione dolce della potenza favorisce la riduzione delle vibrazioni
The smooth transmission of power helps reduce vibrations

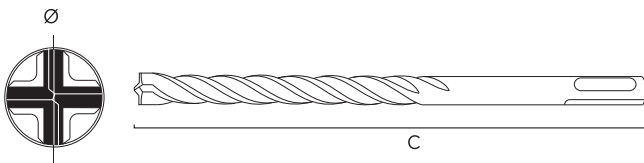
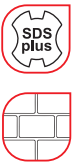

Codice		Ø mm	C mm		Barcode
275050P	SDS plus /SDS plus	5,0	110	10	8033183845146
275050PL	SDS plus /SDS plus	5,0	160	10	8033183846631
275055P	SDS plus /SDS plus	5,5	110	10	8033183845153
275055PL	SDS plus /SDS plus	5,5	160	10	8033183845160
275060P	SDS plus /SDS plus	6,0	110	10	8033183845177
275060PL	SDS plus /SDS plus	6,0	160	10	8033183845184
275060PLL	SDS plus /SDS plus	6,0	210	10	8033183845191
275060PLLL	SDS plus /SDS plus	6,0	260	10	8033183845207
275060PLLLL	SDS plus /SDS plus	6,0	310	10	8033183845214
275065PL	SDS plus /SDS plus	6,5	160	10	8033183845221
275065PLL	SDS plus /SDS plus	6,5	210	10	8033183845238
275065PLLL	SDS plus /SDS plus	6,5	260	10	8033183845245
275065PLLLL	SDS plus /SDS plus	6,5	310	10	8033183845252
275070P	SDS plus /SDS plus	7,0	110	10	8033183845269
275070PL	SDS plus /SDS plus	7,0	160	10	8033183845276

Codice		Ø mm	C mm		Barcode
275080P	SDS plus /SDS plus	8,0	110	10	8033183845283
275080PL	SDS plus /SDS plus	8,0	160	10	8033183845290
275080PLL	SDS plus /SDS plus	8,0	210	10	8033183842671
275080PLLL	SDS plus /SDS plus	8,0	260	10	8033183842688
275080PLLLL	SDS plus /SDS plus	8,0	310	10	8033183845306
275080PLLLL	SDS plus /SDS plus	8,0	460	10	8033183845313
275090PL	SDS plus /SDS plus	9,0	160	10	8033183845320
275010P	SDS plus /SDS plus	10,0	110	10	8033183844613
275010PL	SDS plus /SDS plus	10,0	160	10	8033183844620
275010PLL	SDS plus /SDS plus	10,0	210	10	8033183844637
275010PLLL	SDS plus /SDS plus	10,0	260	10	8033183842695
275010PLLLL	SDS plus /SDS plus	10,0	310	10	8033183842701
275010PLLLL	SDS plus /SDS plus	10,0	450	10	8033183844644
275010PLLLL	SDS plus /SDS plus	10,0	600	10	8033183844651
275010PLLLL	SDS plus /SDS plus	10,0	1000	10	8033183844668

Codice		Ø mm	mm		Barcode
275011PL	SDS plus / SDS plus	11,0	160	10	8033183844675
275011PLL	SDS plus / SDS plus	11,0	210	10	8033183844682
275012PL	SDS plus / SDS plus	12,0	160	10	8033183844699
275012PLL	SDS plus / SDS plus	12,0	210	10	8033183844705
275012PLLLL	SDS plus / SDS plus	12,0	260	10	8033183844712
275012PLLLLL	SDS plus / SDS plus	12,0	310	10	8033183844729
275012PLLLLLL	SDS plus / SDS plus	12,0	450	10	8033183844736
275012PLLLLLLL	SDS plus / SDS plus	12,0	600	10	8033183844743
275012PLLLLLLLL	SDS plus / SDS plus	12,0	1000	10	8033183844750
275013PL	SDS plus / SDS plus	13,0	160	10	8033183844767
275013PLL	SDS plus / SDS plus	13,0	210	10	8033183844774
275013PLLL	SDS plus / SDS plus	13,0	260	10	8033183844781
275013PLLLL	SDS plus / SDS plus	13,0	310	10	8033183844798
275014PL	SDS plus / SDS plus	14,0	160	10	8033183844804
275014PLL	SDS plus / SDS plus	14,0	210	10	8033183844811
275014PLLL	SDS plus / SDS plus	14,0	260	10	8033183844828
275014PLLLL	SDS plus / SDS plus	14,0	310	10	8033183844835
275014PLLLLL	SDS plus / SDS plus	14,0	450	10	8033183844842
275014PLLLLLL	SDS plus / SDS plus	14,0	600	10	8033183844859
275014PLLLLLLL	SDS plus / SDS plus	14,0	1000	10	8033183844866
275015PL	SDS plus / SDS plus	15,0	160	10	8033183844873
275015PLL	SDS plus / SDS plus	15,0	210	10	8033183844880
275015PLLL	SDS plus / SDS plus	15,0	260	10	8033183844897

Codice		Ø mm	mm		Barcode
275015PLLLLLL	SDS plus / SDS plus	15,0	450	10	8033183844903
275016PL	SDS plus / SDS plus	16,0	160	10	8033183844910
275016PLL	SDS plus / SDS plus	16,0	210	10	8033183844927
275016PLLL	SDS plus / SDS plus	16,0	260	10	8033183844934
275016PLLLL	SDS plus / SDS plus	16,0	310	10	8033183844941
275016PLLLLL	SDS plus / SDS plus	16,0	450	10	8033183844958
275016PLLLLLL	SDS plus / SDS plus	16,0	600	10	8033183844965
275016PLLLLLLL	SDS plus / SDS plus	16,0	1000	10	8033183844972
275018PL	SDS plus / SDS plus	18,0	250	10	8033183844989
275018PLLLL	SDS plus / SDS plus	18,0	450	10	8033183844996
275020PL	SDS plus / SDS plus	20,0	250	10	8033183845009
275020PLLLL	SDS plus / SDS plus	20,0	450	10	8033183845016
275022PL	SDS plus / SDS plus	22,0	250	10	8033183845023
275022PLLLL	SDS plus / SDS plus	22,0	450	10	8033183845030
275024PL	SDS plus / SDS plus	24,0	250	10	8033183845047
275024PLLLL	SDS plus / SDS plus	24,0	450	10	8033183845054
275025PL	SDS plus / SDS plus	25,0	250	10	8033183845061
275025PLLLL	SDS plus / SDS plus	25,0	450	10	8033183845078
275028PL	SDS plus / SDS plus	28,0	250	10	8033183845092
275028PLLLL	SDS plus / SDS plus	28,0	450	10	8033183845108
275030PL	SDS plus / SDS plus	30,0	250	10	8033183845115
275030PLLLL	SDS plus / SDS plus	30,0	450	10	8033183845122
275032PLLLL	SDS plus / SDS plus	32,0	450	10	8033183845139

Utensili per foratura metallo

Metal drilling tools

279501 FRESE CONICHE A GRADINO

CONICAL STEP CUTTERS

- Taglienti in acciaio HSS-G ad altissimo rendimento
High performance HSS steel cutting edges
- Gambo cilindrico antiscivolo
Non-slip cylindrical shank
- 2 taglienti rettificati
2 ground cutting edges
- Indicazioni del diametro tramite incisione laser
Diameter indications by laser engraving
- $R \leq 800 \text{ n/mm}^2$
 $R \leq 800 \text{ n/mm}^2$



Codice		mm	gr		Barcode
279501	13 gradini / 13 steps: 4 - 30	97	200	1	8033116531252
279502	9 gradini / 9 steps: 4 - 12	85	35	1	8033183563408
279510	9 gradini / 9 steps: 4 - 20	85	55	1	8033116532419
279512	11 gradini / 11 steps: 6 - 38	90	252	1	8033116532426

279505 FRESE CONICHE A GRADINO ELICOIDALI CONICAL CUTTERS WITH HELICAL STEP

- Taglienti in acciaio HSS-G- ad altissimo rendimento
High performance HSS steel cutting edges
- Gambo cilindrico antiscivolo
Non-slip cylindrical shank
- 2 taglienti elicoidali per massimizzare l'efficacia di taglio
2 helical cutting edges to maximize cutting efficiency
- Indicazioni del diametro tramite incisione laser
Diameter indications by laser engraving
- $R \leq 800 \text{ n/mm}^2$
 $R \leq 800 \text{ n/mm}^2$



Codice		mm	gr		Barcode
279505	9 gradini / 9 steps: 4 - 12	85	200	1	8033183569547
279506	9 gradini / 9 steps: 4 - 20	85	35	1	8033183562296
279507	13 gradini / 13 steps: 4 - 30	97	55	1	8033183562876
279508	13 gradini / 13 steps: 4 - 39	97	252	1	8033183562289

279515 ASSORTIMENTO FRESE CONICHE A GRADINO ASSORTMENT OF CONICAL STEP CUTTERS

Codice	Pezzi / Pieces			Barcode
279515	3	279505 - 279506 - 279507-	1	8033183559500



279500 ASSORTIMENTO FRESE AD INCASSARE E SVASARE ASSORTMENT OF BUILT-IN AND COUNTERSINK CUTTERS

- In acciaio HSS
HSS steel body
- 3 taglienti a 90°
3 cutting edges at 90°

Codice	Pezzi / Pieces	Ø mm		Barcode
279500	6	6,3 - 8,3 - 10,4 - 12,4 - 16,5 - 20,5	1	8033183559500



279514 ASSORTIMENTO MICROFRESE ROTATIVE ROTARY MICRO-MILLS ASSORTMENT

- Corpo cilindrico in metallo duro con durezza > 90 HRC
Cylindrical body in hard metal with hardness > 90 HRC
- 5 forme diverse:
2 x frese cilindriche taglio frontale
2 x frese cilindriche con testa sferica
2 x frese coniche a punta
2 x ogive a punta e sferica
5 different shapes:
2 x cylindrical face cutters
2 x cylindrical end mills with ball head
2 x pointed conical cutters
2 x pointed and spherical ogives



Codice	Pezzi / Pieces			Barcode
279514	10		1	8033183845337

279516 FRESE PERFORTRICI A TAZZA HOLE SAWS

- ◆ Taglienti in acciaio HSS-G con durezza 64HRC
High performance HSS steel cutting edges
- ◆ Esecuzione con scarico laterale rompitruciolo
Execution with chipbreaker side discharge
- ◆ Molla per espulsione dischetto
Disc ejection spring
- ◆ $R < 800 \text{ n/mm}^2$
 $R < 800 \text{ n/mm}^2$

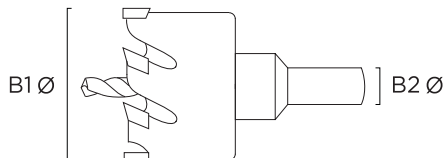

Codice	B1 mm	B2 mm	📦	Barcode
276510	10	10	1	8033183835680
276512	12	10	1	8033183835697
276513	13	10	1	8033183578761
276514	14	10	1	8033183835703
276515	15	10	1	8033183579812
276516	16	10	1	8033183572288
276517	17	10	1	8033183572295
276518	18	10	1	8033183572301
276519	19	10	1	8033183572325
276520	20	10	1	8033183572318
276521	21	10	1	8033183572332
276522	22	10	1	8033183572349
276523	23	10	1	8033183572356
276524	24	10	1	8033183572363
276525	25	10	1	8033183572370
276526	26	10	1	8033183572387
276527	27	10	1	8033183572394
276528	28	10	1	8033183572400
276529	29	10	1	8033183572417
276530	30	10	1	8033183572424
276531	31	10	1	8033183572431
276532	32	10	1	8033183572448
276533	33	10	1	8033183572455
276534	34	10	1	8033183572462
276535	35	10	1	8033183572479
276536	36	10	1	8033183572486
276537	37	10	1	8033183572493
276538	38	10	1	8033183572509
276539	39	13	1	8033183572516

Codice	B1 mm	B2 mm	📦	Barcode
276540	40	13	1	8033183572523
276541	41	13	1	8033183572530
276542	42	13	1	8033183572547
276543	43	13	1	8033183572554
276544	44	13	1	8033183572561
276545	45	13	1	8033183572578
276546	46	13	1	8033183572585
276547	47	13	1	8033183572592
276548	48	13	1	8033183572608
276549	49	13	1	8033183572615
276550	50	13	1	8033183572622
276551	51	13	1	8033183572639
276552	52	13	1	8033183572646
276553	53	13	1	8033183572653
276554	54	13	1	8033183572660
276555	55	13	1	8033183572677
276556	56	13	1	8033183572684
276557	57	13	1	8033183572707
276558	58	13	1	8033183572691
276559	59	13	1	8033183572714
276560	60	13	1	8033183572721
276565	65	13	1	8033183845375
276570	70	13	1	8033183845382
276575	75	13	1	8033183845399
276580	80	13	1	8033183845405
276585	85	13	1	8033183845412
276590	90	13	1	8033183845429
276595	95	13	1	8033183845436
2765100	100	13	1	8033183845443

279504 SET FRESE PERFORTRICI A TAZZA HOLE SAWS SET

Codice	Pezzi / Pieces	Ø mm	📦	Barcode
279504	8	16 - 18 - 20 - 22 - 25 - 30 - 32 - 35	1	8033183845450



278501 FRESA A CORONA IMPACT CORE BIT IMPACT

- In lega di alta qualità, elevata durezza e resistenza
Made of high quality alloy, high hardness and strength
- I fori di scarico assicurano una rimozione del truciolo uniforme
Relief holes ensure uniform chip removal during opening



Codice		Ø mm	mm	📦	Barcode
278501	4 denti / 4 teeth	25,0	75	5	8033183559838
278502	4 denti / 4 teeth	30,0	75	5	8033183569417
278503	4 denti / 4 teeth	35,0	75	5	8033183569424
278504	4 denti / 4 teeth	40,0	75	5	8033183569431
278506	6 denti / 6 teeth	50,0	75	5	8033183561138
278509	6 denti / 6 teeth	60,0	75	5	8033183569448

Codice		Ø mm	mm	📦	Barcode
278511	6 denti / 6 teeth	80,0	75	5	8033183559455
278512	6 denti / 6 teeth	90,0	75	5	8033183569462
278513	8 denti / 8 teeth	100,0	75	5	8033183569487
278514	8 denti / 8 teeth	112,0	75	5	8033183569479
278515	10 denti / 10 teeth	125,0	80	5	8033183569494
278516	10 denti / 10 teeth	130,0	80	5	8033183569486

278520 GAMBI PER FRESE A TAZZA SHANK FOR IMPACT CORE BIT

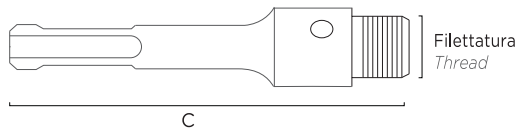

Codice	Gambo / Shank	Filettatura / Thread mm	C mm	📦	Barcode
278520	○	M16	110	1	8033183558107
278521	○	M16	220	1	8033183569493
278522	○	M16	370	1	8033183569509
278601	SDS plus / SDS plus	M22	110	1	8033183569516
278602	SDS plus / SDS plus	M22	220	1	8033183569523
278603	SDS plus / SDS plus	M22	370	1	8033183569530



278611 PUNTA PILOTA PER GAMBI PILOT TIP FOR CORE BIT

- In acciaio HSS
HSS steel body

Codice		Ø mm	mm	📦	Barcode
278611		8	120	1	8033183558879



279511 SET PUNTE FRESATRICI PER LEGNO DA 1/4" 1/4" MILLING BITS SET FOR WOOD

- Interamente in acciaio con testa piatta
Entirely in steel with flat head
- Codolo esagonale da 1/4" per l'attacco diretto all'avvitatore
1/4" hexagonal shank for direct attachment to the electric tool
- Punta di centraggio centrale molata per un'accurato posizionamento
Ground centering point for accurate positioning

Codice	Pezzi / pieces	Ø mm	mm	📦	Barcode
279511	6	10 - 12 - 16 - 18 - 20 - 25	152	1	8033183845351



279513 SET PER FRESA REGOLABILE A COMPASSO
SET FOR ADJUSTABLE COMPASS CUTTER

- Per forare grandi diametri: 40 - 200mm
For drilling large diameters: 40 - 200mm
- Massima velocità di taglio è di 600 giri al minuto
Maximum cutting speed is 600 rpm

CONTENUTO DELLA VALIGETTA:
CONTENTS OF THE CASE

- 2 lame in acciaio ad alta velocità
2 high speed steel blades
- Punta di centraggio
Centering tip
- Attacco regolabile
Adjustable attachment
- Regolazione del diametro di taglio
Adjustment of the cutting diameter
- 1 matita e 1 flessometro 3 mt
1 pencil and 1 tape measure 3 mt
- Copertura trasparente contro la polvere
Transparent dust cover
- 5 punte per legno
5 wood drill bits
- 5 punte per cemento
5 concrete drill bits
- Chiave a brugola per serraggio
Hex key for tightening



Codice	Icona	Barcode
279513	1	8033183845344

279516 SEGHE A TAZZA BIMETALLICHE HSS
HSS BIMETAL HOLE SAWS

- Taglienti in acciaio HSS
Cutting edges in HSS steel
- Dentatura variabile Z=4 ÷ 6
Variable toothing Z = 4 ÷ 6

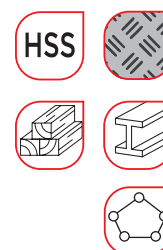

Codice	Ø mm	Icona	Barcode
279516	16	5	8033183561282
279517	17	5	8033183589170
279519	19	5	8033183589187
279520	20	5	8033183560438
279521	21	5	8033183589194
279522	22	5	8033183557582
279524	24	5	8033183561428
279525	25	5	8033183559517
279527	27	5	8033183561435
279529	29	5	8033183559524
279530	30	5	8033183559531
279532	32	5	803318355267
279533	33	5	8033183561435
279535	35	5	8033183559302
279537	37	5	8033183589200
279538	38	5	8033183589422

Codice	Ø mm	Icona	Barcode
279540	40	5	8033183559616
279541	41	5	8033183589217
279543	43	5	8033183589224
279544	44	5	8033183589231
279545	45	5	8033183589248
279546	46	5	8033183555250
279548	48	5	8033183569554
279550	50	1	8033183589248
279551	51	1	8033183589255
279552	52	1	8033183589262
279554	54	1	8033183589279
279555	55	1	8033183589286
279556	56	1	8033183589293
279557	57	1	8033183589309
279559	59	1	8033183589316
279560	60	1	8033183561541

Codice	Ø mm	Icona	Barcode
279562	62	1	8033183558268
279564	64	1	8033183559623
279565	65	1	8033183558275
279567	67	1	8033183589323
279568	68	1	8033183589330
279570	70	1	8033183559630
279573	73	1	8033183589347
279575	75	1	8033183589354
279576	76	1	8033183568342

Codice	Ø mm	Icona	Barcode
279579	79	1	8033183569561
279583	83	1	8033183559319
279586	86	1	8033183589361
279589	89	1	8033183589378
279592	92	1	8033183589385
279595	95	1	8033183589392
279598	98	1	8033183589408
2795100	100	1	8033183589415
2795102	102	1	8033183559326

270530 ASSORTIMENTO SEGHE A TAZZA
HOLE SAWS SET

Codice	Pezzi / Pieces	Ø mm	Icona	Barcode
270530	5	22 - 25 - 29 - 32 - 38	3	8033183562333
270531	9	19 - 22 - 29 - 35 - 38 - 44 - 51 - 57 - 64	3	8033183577207
270532	6	19 - 29 - 35 - 44 - 51 - 64	3	8033183561046

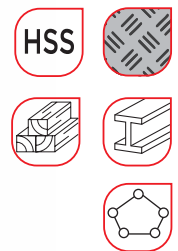

279561P ALBERO PER SEGHE A TAZZA
SHANK FOR HOLE SAWS

- Attacco esagonale 8.5 mm
Hexagonal connection 8.5 mm
- Completo di punta pilota in acciaio HSS
Complete with HSS steel pilot tip

Codice	Ø mm	Icona	Barcode
279561P	14 - 30	3	8033183558251
279562P	32 - 152	3	8033183558268



279565P PUNTA PILOTA PER ALBERO PER SEGHE
PILOT DRILL FOR HOLE SAWS

- In acciaio HSS
HSS steel

Codice	Ø mm	mm	Icona	Barcode
279565P	6,35	80	3	8033183558275
279566P	6,35	105	3	8033183558282



Utensili a filettare

Threading tools

279801 MASCHI A MACCHINA MACHINE TAPS

- In acciaio HSS-G
HSS steel
- $R < 600 \text{ n/mm}^2$
 $R < 600 \text{ n/mm}^2$

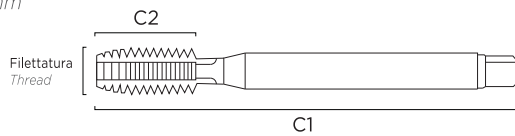

HSS-G



Codice	Filettatura / Thread mm	C1 mm	C2 mm		Barcode
279801	M3 x 0,5	56	11	1	8033183557452
279802	M4 x 0,7	63	13	1	8033183557469
279803	M5 x 0,8	70	16	1	8033183558527
279804	M6 x 1	80	19	1	8033183557476
279806	M8 x 1,25	90	22	1	8033183558534
279807	M10 x 1,5	100	24	1	8033183558541
279808	M12 x 1,75	110	29	1	8033183561572

279509 SET PER FILETTARE THREADING SET

- Maschi in serie di 2 da M3 a M12
Taps in series of 2 from M3 to M12
- Punta laminate 2,5 3,3 4,2 5,0 6,0 8,0mm
Laminated tips 2.5 3.3 4.2 5.0 6.0 8.0mm
- Filiere + giramaschio + girofiliera
Spinnerets + tap wrench + spinner

Codice		Barcode
279509	1	8033183841605



ESECUZIONE AD ALTE PRESTAZIONI

HIGH PERFORMANCE EXECUTION



PER METALLI
FOR METALS



PER LEGNO
FOR WOOD



PER ACCIAIO
FOR STEEL



PER ACCIAIO INOX
FOR STAINLESS STEEL



PER PIETRA
FOR STONE

264 Mole da taglio
Cutting wheels

266 Lime
Files

Taglio e levigatura

Cutting and sanding

Mole da taglio

Cutting wheels

- 1** Estremamente taglienti, taglia senza difficoltà anche in condizioni scomode.
Extremely sharp, it cuts without difficulty even in uncomfortable conditions.
- 2** Spessori minimi per tagli sottili.
Minimum thicknesses for thin cuts.
- 3** Per l'utilizzo su macchine portatili elettriche o pneumatiche.
For use in portable electric or pneumatic machines.

560109 MOLE RINFORZATE A CENTRO DEPRESSO DEPRESSED CENTER REINFORCED WHEELS

- Velocità massima d'esercizio: 80m/s _ 13300 giri/min
Maximum operating speed: 80m/s _ 13300 rpm
- Campi d'impiego: acciaio INOX, acciai ad alta resistenza
Fields of use: stainless steel, high-strength steels

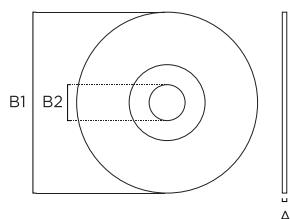

Codice	B1 mm	B2 mm	A mm		Barcode
560109	115	22	6,4	20	8033183580887
560110	230	22	6,5	10	8033183580894



560136 MOLE RINFORZATE A CENTRO DEPRESSO DEPRESSED CENTER REINFORCED WHEELS

- Velocità massima d'esercizio: 80m/s _ 13300 giri/min
Maximum operating speed: 80m/s _ 13300 rpm
- Campi d'impiego: metallo, acciaio
Fields of use: metal, steel

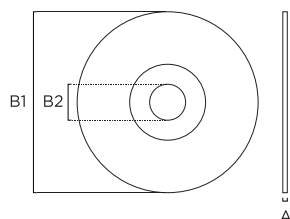

Codice	B1 mm	B2 mm	A mm		Barcode
560136	115	22	3,2	25	8033183580849
560137	230	22	3,2	25	8033183560469



561138 MOLE RINFORZATE A CENTRO DEPRESSO DEPRESSED CENTER REINFORCED WHEELS



- Velocità massima d'esercizio: 80m/s _ 13300 giri/min
Maximum operating speed: 80m/s _ 13300 rpm
- **Campi d'impiego:** pietra, cemento, marmo, granito, ghisa, bronzo e alluminio
Fields of use: stone, concrete, marble, granite, cast iron, bronze and aluminum

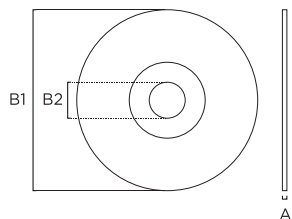

Codice	B1 mm	B2 mm	A mm		Barcode
561138	115	22	3,2	25	8033183580900
561139	230	22	3,2	25	8033183558220
561140	115	22	1,0	50	8033183580917
561141	115	22	1,6	50	8033183580924
561142	115	22	2,0	50	8033183580931

562120 MOLE RINFORZATE A CENTRO PIANO CENTER-FLOOR REINFORCED WHEELS



- Velocità massima d'esercizio: 80m/s _ 13300 giri/min
Maximum operating speed: 80m/s _ 13300 rpm
- **Campi d'impiego:** acciaio INOX, acciaio e ferro
Fields of use: stainless steel, steel and iron

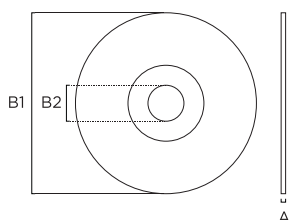

Codice	B1 mm	B2 mm	A mm		Barcode
562120	115	22	1,6	50	8033183560094
562122	115	22	1,0	50	8033183580856
562141	230	22	2,0	50	8033183560087

562121 MOLE RINFORZATE A CENTRO PIANO CENTER-FLOOR REINFORCED WHEELS



- Velocità massima d'esercizio: 80m/s _ 13300 giri/min
Maximum operating speed: 80m/s _ 13300 rpm
- **Campi d'impiego:** pietra, marmo, bronzo, granito, ghisa e alluminio
Fields of use: stone, marble, bronze, granite, cast iron and aluminum

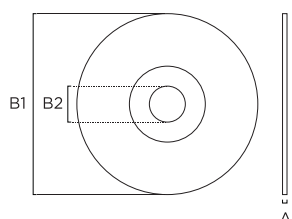

Codice	B1 mm	B2 mm	A mm		Barcode
562121	115	22	1,6	10	8033183559708
562142	230	22	2,5	10	8033183562258

561001 MOLE RINFORZATE A CENTRO PIANO CENTER-FLOOR REINFORCED WHEELS

- Velocità massima d'esercizio: 80m/s _ 13300 giri/min
Maximum operating speed: 80m/s _ 13300 rpm
- Campi d'impiego: legno
Fields of use: wood

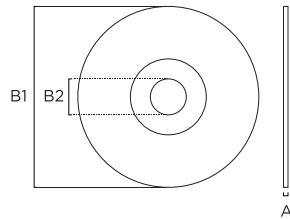

Codice	B1 mm	B2 mm	A mm		Barcode
561001	115	22	1,6	10	8033183557612
561002	230	22	2,0	10	8033183560049

630019 DISCO LAMELLARE A CENTRO DEPRESSO FLAP DISC WITH DEPRESSED CENTER

- Supporto in nylon zinconio
Support in zirconium nylon
- Velocità massima d'esercizio: 80m/s _ 13300 giri/min
Maximum operating speed: 80m/s _ 13300 rpm
- Campi d'impiego: rimozione di bave e residui di acciai
Fields of use: removal of burrs and steel residues

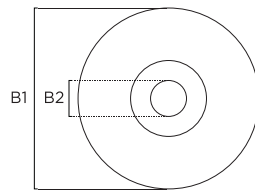

Codice	B1 mm	B2 mm		Barcode	
630019	Z040 BLU	115	22	20	8033183557612
630020	Z060 BLU	115	22	20	8033183560049
630021	Z0480 BLU	115	22	20	8033183557612
630022	Z0120 BLU	115	22	20	8033183560049

Lime Files

875010 SET LIMETTE PER CONTATTI CONTACT LIMES SET

- Profilo piatto parallelo in acciaio con impugnatura
Parallel flat steel profile with handle

Codice	mm	gr		Barcode
875010	160	60	1	8033183550538



875011 SET LIMETTE

FILES SET

- ◆ Impugnatura in legno
Wooden handle
- ◆ 5 tipologie di profili:
Lima piatta
3 x lime ad ago (tonda, quadrata, triangolare)
Lima a coltello
Lima mezzatonda
5 types of profiles:
Flat file
3 x needle files (round, square, triangular)
Knife file
Half-round file

Codice	mm	gr		Barcode
875011	180	140	1	8033116533652



273001 LIME PER MECCANICA

FILES FOR MECHANICS

- ◆ Barra in acciaio a taglio incrociato mezzodolce per rifinire la sgrossatura e dare inizio alla levigatura
Half-sweet cross-cut steel bar to finish the roughing and start sanding
- ◆ Impugnatura in bimateriale
Bi-material handle
- ◆ 5 tipologie di profili
5 types of profiles

Codice	Pezzi / Pieces		mm	gr		Barcode
273001		Piatta /Flat	250	200	5	8033183550699
273101		Mezzatonda /Half-round	300	200	5	8033183550705
273201		Quadrata /Square	300	200	5	8033183550712
273301		Tonda /Round	200	200	5	8033183550729
273401		Triangolare /Triangular	200	200	5	8033183550736
273501	5	Set lime /Files set: 1 x 273001 - 273101 - 273201 - 273301 - 273401		1180	2	8033183550743



LA SOLUZIONE PER OGNI MURATURA

THE SOLUTION FOR EVERY MASONRY



PROFILO ESAGONALE
HEXAGONAL PROFILE



PROFILO A CROCE "PHILLIPS"
"PHILLIPS" CROSS PROFILE



PROFILO A CROCE "POZIDRIV"
"POZIDRIV" CROSS PROFILE



PROFILO COMBINATO
COMBINED PROFILE

271 Tasselli in nylon
Nylon dowels

277 Tasselli leggeri prolungati
Prolonged light blocks

280 Tasselli in acciaio
Steel dowels

282 Tasselli per idrotermosantaria
Plugs for plumbing

COME SCEGLIERE UN TASSELLO

HOW TO CHOOSE A DOWEL

Vi sono diverse tipologie di tasselli ed ognuna di queste si adatta ad un'esigenza specifica.

La scelta si basa quindi su tre fattori essenziali:

There are different types of dowels, and each of these adapts to a specific need.

The choice is therefore based on three essential factors:

- 1 I materiali sul quale inserire il tassello, che determinerà la tipologia di tassello da utilizzare.**
The materials on which to insert the dowel, which will determine the type of dowel to be used.
- 2 Il peso che deve sopportare il tassello, che determinerà la lunghezza e il diametro del tassello.**
The weight that the dowel must bear, which will determine the length and diameter of the dowel.
- 3 La tipologia di elemento che il tassello deve supportare, che determinerà la testa del tassello.**
The type of element that the dowel must support, which will determine the head of the dowel

TIPI DI MATERIALI PER LA SCELTA DEI TASSELLI

TYPES OF MATERIALS FOR CHOOSING DOWELS

MATERIALI PIENI: materiali da costruzione che non presentano spazi vuoti (mattono pieno, calcestruzzo)

SOLID MATERIALS: building materials that do not have gaps (solid brick, concrete)

MATERIALI CAVI: materiali da costruzione che presentano spazi vuoti (mattoni forati, cartongesso, calcestruzzo vuoto)

HOLLOW MATERIALS: building materials that have gaps (hollow brick, plasterboard, hollow concrete)

MATERIALI FRIABILI: tutte quelle materie prime che possono sfaldarsi (calcestruzzo cellulare)

FRIABLE MATERIALS: all those raw materials that can flake off (cellular concrete)

TIPOLOGIE DI TASSELLI

TYPES OF DOWELS

LEGGERI / LIGHTWEIGHT

TASSELLI IN NYLON: l'espansione del tassello avviene generalmente avvitando una vite di acciaio.

Ciò significa che l'espansione della parte in nylon crea un contrasto nei confronti delle pareti interne del blocco forato o della superficie della lastra dell'elemento vuoto.

A seconda della lunghezza e del diametro del tassello, quest'ultimo riuscirà a sostenere carichi più o meno elevati.

NYLON DOWELS: expansion of the dowel generally takes place by screwing a steel screw. This means that the expansion of the nylon part creates a contrast with the internal walls of the perforated block or the surface of the plate of the empty element.

Depending on the length and diameter of the dowel, the latter will be able to withstand more or less high loads.



























ALTRI TASSELLI LEGGERI: tasselli autofilettanti i quali funzionano con lo stesso principio delle viti, tanto che è possibile fissarli all'interno del muro mediante la filettatura presente all'esterno.

OTHER LIGHT DOWELS: self-tapping anchors which work on the same principle as screws, so much so that it is possible fix them inside the wall using the thread on the outside.

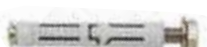
PESANTI / HEAVY

TASSELLI MECCANICI: Questa tipologia di tasselli trasferisce, per attrito, il carico al materiale di supporto grazie all'effetto dell'espansione del tassello stesso che può avvenire serrando il dado con chiave dinamometrica o mediante avvitamento della vite all'interno del corpo di espansione.

MECHANICAL DOWELS: This type of dowels transfers, by friction, the load to the support material thanks to the effect expansion of the dowel itself which can be done by tightening the nut with a torque wrench or by screwing the screw inside the expansion body.

				Materiali pieni / Full materials			Materiali cavi / Hollow materials		M. friabili / Brittle m.	
		Pag	Codice / Code							
TASSELLI UNIVERSALI / UNIVERSAL DOWELS	271		620005 620012		●	●		●	●	●
	272		620006C		●	●		●	●	●
	272		620006CC		●	●		●	●	●
	273		610006 610012T		●	●		●		●
	273		610027						●	●
	275		610009 610011 610017	610019 610021 	●	●	●	●	●	
TASSELLI PROLUNGATI / EXTENDED DOWELS	277		61006L		●	●	●	●		●
	277		610028		●			●		●
	278		610015		●	●	●	●		●
	278		610040		●	●	●	●		
	278		610009P 610011P 610019P		●	●	●	●	●	
TASSELLI IN METALLO / METAL DOWELS	280		610035			●	●			
	280		610045		●	●	●			
	280		610023 610025 610026					●	●	●
TASSELLI PER TERMOISANITARIA / PLUGS FOR THERMO-SANITARY SYSTEMS	282		610048		●	●		●	●	
	282		610050		●	●		●		
	283		610060			●	●			●
	283		610066		●	●	●			●
	283		610065		●	●	●			●
	284		610071		●	●		●		
	284		610077 610075 610081		●	●		●		

12

Tasselli in nylon

Nylon dowels

Tasselli universali

Universal dowels

620005 TASSELLI A 4 SETTORI CON VITE A CROCE

4 SECTOR DOWELS WITH CROSS SCREW

- Corpo in nylon a 4 settori
4 sector nylon body
- L'espansione sui 4 lati permette una perfetta aderenza
The expansion on the 4 sides allows a perfect fit
- Viti a croce zincate
Cross zinc-plated screws
- Confezione secchiello appendibile
Hanging bucket package



Codice	Pezzi / Pieces	Fissaggio / Fixing	B1 x C1 mm	B2 x C2 mm	📦	Barcode
620005		Leggero / Light	5 x 25	3,5 x 30	150	8033183582645
620006		Leggero / Light	6 x 30	4,0 x 40	100	8033183572790
620008		Leggero / Light	8 x 40	5,0 x 45	50	8033183572806
620010		Leggero / Light	10 x 50	6,0 x 60	50	8033183577283
620006/250		Leggero / Light	6 x 30	4,0 x 40	250	8033183846617
620006/400		Leggero / Light	6 x 30	4,0 x 40	400	8033183846600
62000E	24	Espositore / Exhibitor art. 620006			1	8033183581273

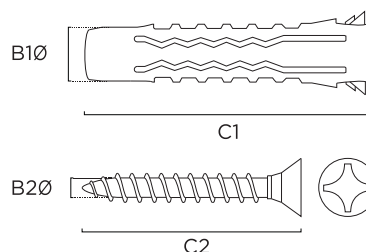

620012 TASSELLI A 4 SETTORI CON VITE ESAGONALE

4 SECTOR DOWELS WITH HEXAGONAL SCREW

- Corpo in nylon a 4 settori
4 sector nylon body
- L'espansione sui 4 lati permette una perfetta aderenza
The expansion on the 4 sides allows a perfect fit
- Viti a testa esagonale
Hex head screws
- Confezione secchiello appendibile
Hanging bucket package



Codice	Fissaggio / Fixing	B1 x C1 mm	B2 x C2 mm	📦	Barcode
620012	Leggero / Light	12 x 60	8 x 80	50	8033183577290
620014	Leggero / Light	14 x 70	10 x 80	50	8033183585578

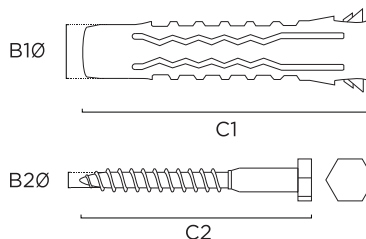



620006C TASSELLI A 4 SETTORI COLORATI 4 SECTOR COLORED DOWELS

- Corpo in nylon colorato rosso a 4 settori espandibili
Red nylon body with 4 expandable sectors
- Alette antirotazione ad alta rigidezza per evitare qualsiasi rischio di rotazione al passaggio della vite
High stiffness anti-rotation fins to avoid any risk of rotation as the screw passes
- Viti a croce zincate
Cross zinc-plated screws
- Confezione secchiello appendibile
Hanging bucket package

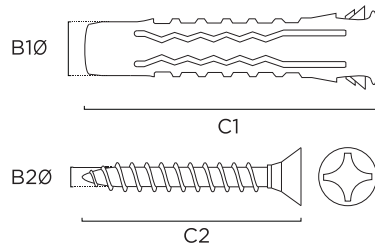

Codice		B1 x C1 mm	B2 x C2 mm		Barcode
620006C	●	6 x 30	4,5 x 4	100	8033183581006
620008C	●	8 x 40	5,5 X 5	50	8033183581013



620006CC TASSELLI A 4 SETTORI IN BI-MATERIALE 4 SECTOR DOWELS IN BI-MATERIAL

- Corpo in nylon a due materiali che garantiscono alte prestazioni, flessibilità, affidabilità e performance altissime
Two-material nylon body that guarantee high performance, flexibility, very high reliability and performance
- Alette antirotazione ad alta rigidezza per evitare qualsiasi rischio di rotazione al passaggio della vite.
High stiffness anti-rotation fins to avoid any risk of rotation as the screw passes
- Controllo totale della posa grazie ai 2 anelli rinforzati che controllano la flessione e l'annodamento
Total control of the installation thanks to the 2 reinforced rings that they control bending and knotting
- L'espansione sui 4 lati permette una perfetta aderenza
The expansion on the 4 sides allows a perfect fit
- Viti a croce zincate
Cross zinc-plated screws
- Confezione secchiello appendibile
Hanging bucket package

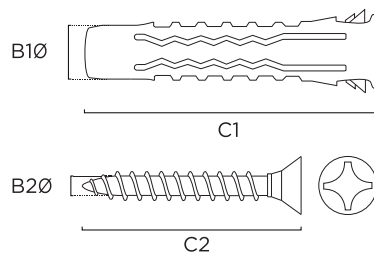



Codice		B1 x C1 mm	B2 x C2 mm		Barcode
620006CC	● ●	6 x 35	4,5 x 45	50	8033183837691
620008CC	● ●	8 x 50	5,0 X 60	25	8033183837707

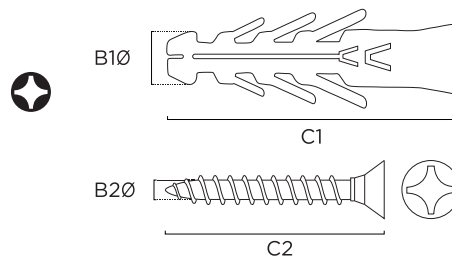

610006 TASSELLI A 6 ALETTE CON VITE A CROCE 6 FINS DOWELS WITH CROSS SCREW

- Corpo in nylon a struttura rinforzata
Reinforced structure nylon body
- Sistema a 6 alette che gli consente di avere una tenuta superiore di circa il 30% rispetto ai comuni tasselli universali
6-fin system that allows it to have a superior seal about 30% compared to common universal anchors
- Viti a croce zincate
Cross zinc-plated screws
- Confezione secchiello appendibile
Hanging bucket package



Codice	Pezzi / Pieces	Fissaggio / Fixing	B1 x C1 mm	B2 x C2 mm		Barcode
610006		Leggero / Light	6 x 30	4,0 x 40	100	8033183572776
610008		Leggero / Light	8 x 40	5,0 x 45	50	8033183572783
610006/400		Leggero / Light	6 x 30	4,0 x 40	400	8033183846624
610010T		Leggero / Light	10 x 50	6,0 x 80	50	8033183578730
61000E	24	Espositore / Exhibitor art. 610006			1	8033183845689

610012T TASSELLI AD ALETTE CON VITE ESAGONALE 6 FINS DOWELS WITH HEXAGONAL SCREW

- Corpo in nylon ad espansione
Expansion nylon body
- Speciali alette che impediscono la rotazione nel foro
Special fins that prevent rotation in the hole
- Viti a testa esagonale
Hex head screws
- Confezione secchiello appendibile
Hanging bucket package

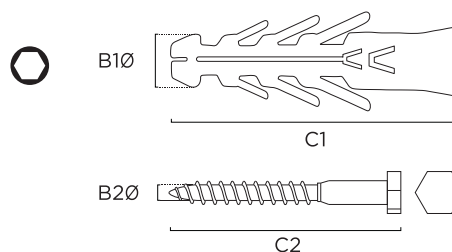

Codice	Fissaggio / Fixing	B1 x C1 mm	B2 x C2 mm		Barcode
610012T	Leggero / Light	12 x 60	8 x 80	50	8033183578747
610014T	Leggero / Light	14 x 70	10 x 80	20	8033183585561

610027 TASSELLI AUTOFORANTI PER CARTONGESSO SELF-DRILLING DOWELS FOR PLASTERBOARD

- Corpo autoperforante in nylon
Self-drilling body in nylon
- Non necessitano dell'utilizzo di inserti speciali nè di punte per preforare, la stessa punta del tassello garantisce un'ottima perforazione
They do not require the use of special inserts or pre-drilling tips, the same tip of the dowel guarantees excellent perforation
- Viti in acciaio al carbonio zincate, con testa a croce "pozidriv"
Screws in galvanized carbon steel, with "pozidriv" cross head
- Confezione secchiello appendibile
Hanging bucket package



Codice	Fissaggio / Fixing	mm	Vite / Lives		Barcode
610027	Leggero / Light	40	4,0 x 40	100	8033183591029

Kit tasselli universali

Universal dowels kit

610006F KIT TASSELLI A 6 ALETTE + FORBICI 6 WINGS DOWELS + SCISSORS KIT

- Tasselli con corpo in nylon rinforzati a 6 alette + viti zincate
6 fin reinforced nylon body plugs + zinc plated screws
- Forbice per elettricisti: cod. 230836
Scissors for electricians: cod. 230836
- Confezione secchiello appendibile
Hanging bucket package



Codice			Barcode
610006F	⊗	KIT: 610006 + 230836	400 8033183598929
610008F	⊗	KIT: 610008 + 230836	200 8033183598493
610010TF	⊙	KIT: 610010T + 230836	150 8033183845696

620005F KIT TASSELLI A 4 SETTORI + FORBICI 4-SECTOR DOWELS KIT+ SCISSORS

- Tasselli con corpo in nylon a 4 settori + viti zincate
Dowels with 4 sectors nylon body + galvanized screws
- Forbice per elettricisti: cod. 230836
Scissors for electricians: cod. 230836
- Confezione secchiello appendibile
Hanging bucket package



Codice			Barcode
620005F	⊗	KIT: 620005 + 230836	400 8033183595744
620006F	⊗	KIT: 620006 + 230836	400 8033183595645
620008F	⊗	KIT: 620005 + 230836	200 8033183595652
620010F	⊗	KIT: 620010 + 230836	150 8033183596192

Tasselli con pitoneria

Dowels with anchorage system

610009 TASSELLI AD ALETTE CON VITE COMBINATA WING DOWELS WITH COMBINED SCREW

- Corpo senza bordo in nylon ad espansione
Body without rim in expanding nylon
- Speciali alette che impediscono la rotazione nel foro
Special fins that prevent rotation in the hole
- Viti a testa combinata M4 + rondella metallica
M4 combination head screws + metal washer
- Confezione secchiello appendibile
Hanging bucket package



Codice	Fissaggio / Fixing	B1 x C1 mm	Vite / Lives		Barcode
610009	Leggero / Light	9 x 40	M4	100	8033183575098
610010	Leggero / Light	12 x 45	M5	50	8033183575104

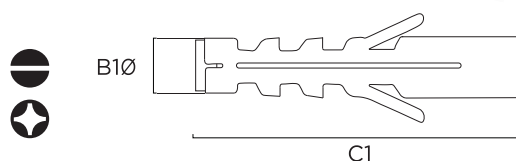

610011 TASSELLI AD ALETTE CON GANCIO DOWELS WITH WINGS WITH HOOK

- Corpo senza bordo in nylon ad espansione
Body without rim in expanding nylon
- Speciali alette che impediscono la rotazione nel foro
Special fins that prevent rotation in the hole
- Gancio + rotella metallica
Hook + metal wheel
- Confezione secchiello appendibile
Hanging bucket package

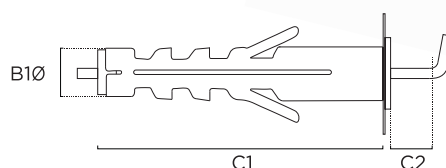
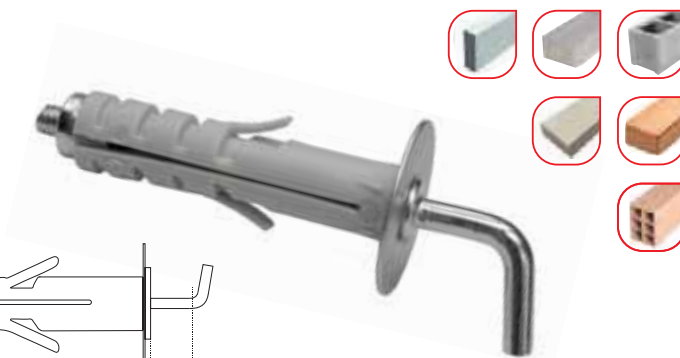

Codice	Fissaggio / Fixing	B1 x C1 mm	C2 mm	Gancio / Hook		Barcode	
610011	Gancio corto / Short hook	Leggero / Light	9 x 40	4,0	M4	100	8033183575111
610012	Gancio corto / Short hook	Leggero / Light	12 x 45	4,5	M5	50	8033183575128
610013	Gancio medio / Medium hook	Leggero / Light	9 x 40	10,0	M4	100	8033183575135
610014	Gancio medio / Medium hook	Leggero / Light	12 x 45	10,0	M5	50	8033183575142
610015	Gancio lungo / Long hook	Leggero / Light	9 x 40	17,0	M4	100	8033183575159
610016	Gancio lungo / Long hook	Leggero / Light	12 x 45	19,0	M5	50	8033183575166

610017 TASSELLI AD ALETTE AD OCCHIELLO APERTO WINGED ANCHORS WITH OPEN EYELET

- Corpo senza bordo in nylon ad espansione
Body without rim in expanding nylon
- Speciali alette che impediscono la rotazione nel foro
Special fins that prevent rotation in the hole
- Gancio ad occhio aperto + rotella metallica
Open eye hook + metal wheel
- Confezione secchiello appendibile
Hanging bucket package



Codice	Fissaggio / Fixing	B1 x C1 mm	A mm	Gancio / Hook		Barcode
610017	Leggero / Light	9 x 40	8	M4	100	8033183575173
610018	Leggero / Light	12 x 45	10	M5	50	8033183575180

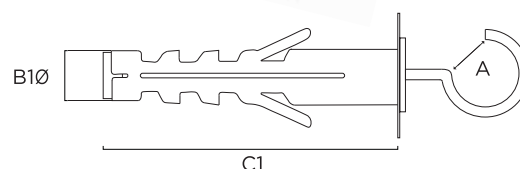

610019 TASSELLI AD ALETTE AD OCCHIELLO CHIUSO WINGED ANCHORS WITH CLOSED EYELET

- Corpo senza bordo in nylon ad espansione
Body without rim in expanding nylon
- Speciali alette che impediscono la rotazione nel foro
Special fins that prevent rotation in the hole
- Gancio ad occhiello chiuso + rotella metallica
Closed eye hook + metal roller
- Confezione secchiello appendibile
Hanging bucket package

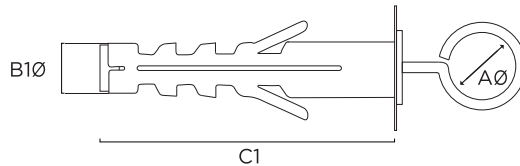

Codice	Fissaggio / Fixing	B1 x C1 mm	A mm	Gancio / Hook	📦	Barcode
610019	Leggero / Light	9 x 40	13	M4	100	8033183575197
610020	Leggero / Light	12 x 45	14	M5	50	8033183575203

610021 TASSELLI AD ALETTE CON DOPPIO DADO WING DOWELS WITH DOUBLE NUT

- Corpo senza bordo in nylon ad espansione
Body without rim in expanding nylon
- Speciali alette che impediscono la rotazione nel foro
Special fins that prevent rotation in the hole
- Vite con doppio dado in acciaio zincocromato + rondella metallica
Screw with double nut in zinc-chromated steel + metal washer
- Confezione secchiello appendibile
Hanging bucket package

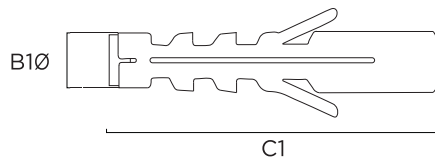

Codice	Fissaggio / Fixing	B1 x C1 mm	Vite / Lives	📦	Barcode
610021	Leggero / Light	9 x 40	M4 x 43	100	8033183575210
610022	Leggero / Light	12 x 45	M5 x 48	50	8033183575227

Tasselli leggeri prolungati

Extended light blocks

610006L TASSELLI PROLUNGATI A 4 SETTORI CON VITE A CROCE 4 SECTOR EXTENDED AXELS WITH CROSS SCREW

- ♦ Corpo prolungato bordato in nylon a 4 settori
Extended body in nylon with 4 sectors
- ♦ L'espansione sui 4 lati permette una perfetta aderenza
The expansion on the 4 sides allows a perfect fit
- ♦ Viti a croce zincate
Cross zinc-plated screws
- ♦ Confezione secchiello appendibile
Hanging bucket package

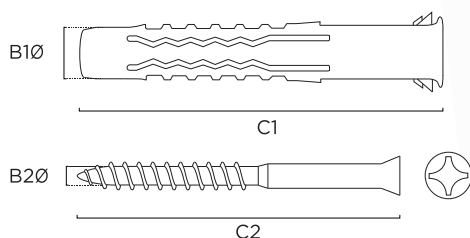

Codice	Fissaggio / Fixing	B1 x C1 mm	B2 x C2 mm	📦	Barcode
620006L	Leggero / Light	6 x 60	4,0 x 70	50	8033183581198
620008L	Leggero / Light	8 x 80	5,5 x 85	50	8033183581204
620008LL	Leggero / Light	8 x 100	5,5 x 105	50	8033183581211

Codice	Fissaggio / Fixing	B1 x C1 mm	B2 x C2 mm	📦	Barcode
620010L	Leggero / Light	10 x 100	7,0 x 105	50	8033183581228
620010LL	Leggero / Light	10 x 120	7,0 x 125	50	8033183581235

610028 TASSELLI PROLUNGATI AD ALETTE EXTENDED DOWELS WITH FLAPS

- ♦ Corpo prolungato in nylon a struttura rinforzata
Extended body in reinforced nylon structure
- ♦ Sistema a 6 alette
6 fin system
- ♦ Viti TPS con taglio a croce "pozidriv"
TPS "pozidriv" cross recessed screws
- ♦ Confezione secchiello appendibile
Hanging bucket package

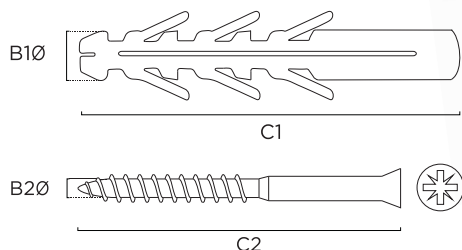

Codice	Fissaggio / Fixing	B1 x C1 mm	B2 x C2 mm	📦	Barcode
610028	Leggero / Light	8 x 80	5,5 x 85	100	8033183591678
610029	Leggero / Light	8 x 100	5,5 x 105	100	8033183591685
610030	Leggero / Light	8 x 120	5,5 x 125	100	8033183591692
610031	Leggero / Light	10 x 100	7,0 x 105	100	8033183591708

Codice	Fissaggio / Fixing	B1 x C1 mm	B2 x C2 mm	📦	Barcode
610032	Leggero / Light	10 x 115	7,0 x 120	100	8033183591715
610033	Leggero / Light	10 x 135	7,0 x 140	100	8033183591722
610034	Leggero / Light	10 x 160	7,0 x 165	100	8033183591858

620015 TASSELLI PROLUNGATI A CHIODO EXTENDED NAIL DOWELS

- ♦ Corpo lungo in nylon con bordo bombato che garantisce un'ottima tenuta
Long nylon body with rounded edge that guarantees excellent sealing
- ♦ Montaggio rapido a percussione riduce la quantità di tempo necessario per l'installazione
Quick percussion assembly reduces the amount of time required for installation
- ♦ Viti a chiodo premontate con taglio a croce "pozidriv"
Preassembled nail screws with "pozidriv" cross recess
- ♦ Confezione secchiello appendibile
Hanging bucket package



Codice	Fissaggio / Fixing	mm		Barcode
620015	Leggero / Light	6 x 40	200	8033183575159
620016	Leggero / Light	6 x 60	200	8033183595126



610040 TASSELLI PROLUNGATI A CHIODO EXTENDED NAIL DOWELS

- ♦ Corpo lungo in nylon a bordo svasato
Long nylon body with flared edge
- ♦ Montaggio rapido a percussione riduce la quantità di tempo necessario per l'installazione
Quick percussion assembly reduces the amount of time required for installation
- ♦ Viti a chiodo premontate con taglio a croce "pozidriv"
Preassembled nail screws with "pozidriv" cross recess
- ♦ Confezione secchiello appendibile
Hanging bucket package



Codice	Fissaggio / Fixing	mm		Barcode
610040	Leggero / Light	6 x 40	100	8033183591654
610041	Leggero / Light	6 x 60	100	8033183591661
610042	Leggero / Light	6 x 80	100	8033183591104
610043	Leggero / Light	8 x 80	100	8033183591111
610044	Leggero / Light	8 x 100	100	8033183591845



610009P TASSELLI PROLUNGATI AD ALETTE CON VITE COMBINATA EXTENDED AXELS WITH FINS WITH COMBINED SCREW

- ♦ Corpo prolungato senza bordo in nylon
Extended body without nylon edge
- ♦ Speciali alette che impediscono la rotazione nel foro
Special fins that prevent rotation in the hole
- ♦ Viti a testa combinata M4 + rondella metallica
M4 combination head screws + metal washer
- ♦ Confezione secchiello appendibile
Hanging bucket package

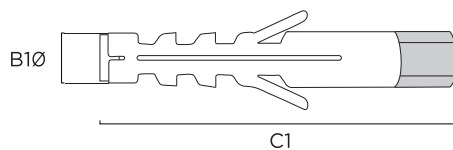

Codice	Fissaggio / Fixing	B1 x C1 mm		Barcode
610009P	Leggero / Light	9 x 50	100	8033183833068
610010P	Leggero / Light	12 x 53	50	8033183833075

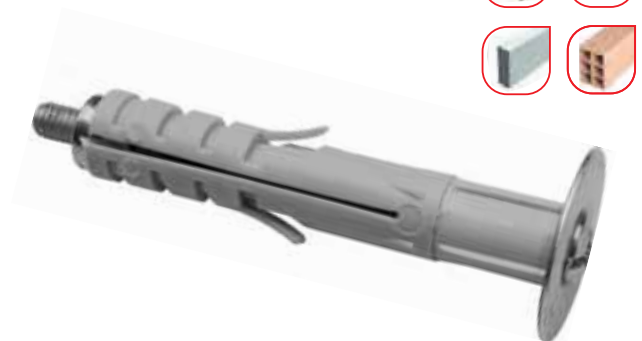

610011P TASSELLI PROLUNGATI AD ALETTE CON GANCIO EXTENDED DOWELS WITH FINS AND HOOK

- Corpo prolungato senza bordo in nylon
Extended body without nylon edge
- Speciali alette che impediscono la rotazione nel foro
Special fins that prevent rotation in the hole
- Gancio + rotella metallica
Hook + metal wheel
- Confezione secchiello appendibile
Hanging bucket package

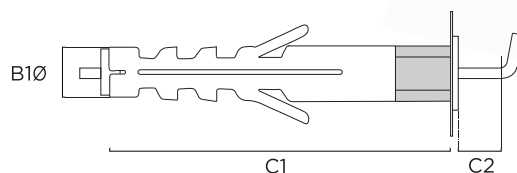

Codice	Fissaggio / Fixing	B1 x C1 mm	C2 mm	Gancio / Hook		Barcode	
610011P	Gancio corto / Short hook	Leggero / Light	9 x 50	4,0	M4	100	8033183833082
610012P	Gancio corto / Short hook	Leggero / Light	12 x 53	4,5	M5	50	8033183833099
610013P	Gancio medio / Medium hook	Leggero / Light	9 x 50	10,0	M4	100	8033183833112
610014P	Gancio medio / Medium hook	Leggero / Light	12 x 53	10,0	M5	50	8033183833129

610019P TASSELLI PROLUNGATI AD ALETTE AD OCCHIELLO CHIUSO EXTENDED DOWELS WITH FINS CLOSED EYELET

- Corpo prolungato senza bordo in nylon
Extended body without nylon edge
- Speciali alette che impediscono la rotazione nel foro
Special fins that prevent rotation in the hole
- Gancio ad occhietto chiuso + rotella metallica
Closed eye hook + metal roller
- Confezione secchiello appendibile
Hanging bucket package

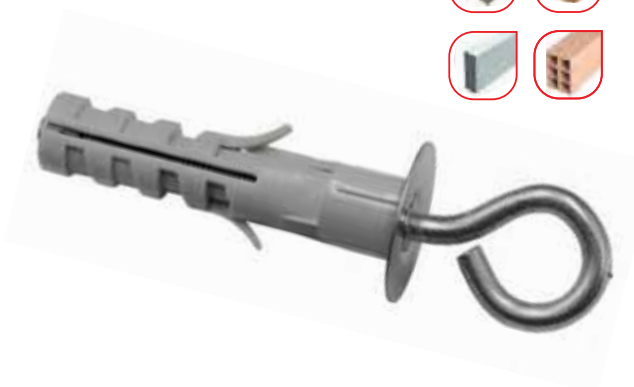
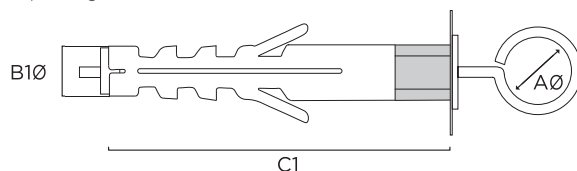

Codice	Fissaggio / Fixing	B1 x C1 mm	A mm	Gancio / Hook		Barcode
610019P	Leggero / Light	9 x 50	13	M4	100	8033183833136
610020P	Leggero / Light	12 x 53	14	M5	50	8033183833143

Tasselli in acciaio

Steel anchors

610035 TASSELLI A ESPANSIONE IN ACCIAIO

STEEL EXPANSION DOWELS

- ♦ Corpo in acciaio zincato
Body in galvanized steel
- ♦ La lunga filettatura permette di fissare oggetti di vario spessore e permette l'eventuale installazione distanziata
The long thread allows you to fix objects of various thicknesses and allows the eventual spaced installation
- ♦ Completo di dado + rondella
Complete with nut + washer
- ♦ Confezione secchiello appendibile
Hanging bucket package

Codice	Fissaggio / Fixing	mm	Dado / nut	📦	Barcode
610035	Pesante / Heavy	8 x 75	M8	100	8033183594075
610036	Pesante / Heavy	8 x 90	M8	50	8033183598165
610037	Pesante / Heavy	10 x 90	M10	50	8033183591142



Codice	Fissaggio / Fixing	mm	Dado / nut	📦	Barcode
610038	Pesante / Heavy	10 x 120	M10	50	8033183591159
610039	Pesante / Heavy	12 x 110	M12	25	8033183598172

610045 TASSELLI A ESPANSIONE IN ACCIAIO

STEEL EXPANSION DOWELS

- ♦ Corpo in acciaio zincato a due settori
Two-sector galvanized steel body
- ♦ Il tappo in plastica rosso protegge la filettatura dalla polvere di foratura, assicurando così un corretto funzionamento
The red plastic cap protects the thread from drilling dust, thus ensuring correct operation
- ♦ Viti a testa esagonale + rondella metallica
Hex head screws + metal washer
- ♦ Confezione secchiello appendibile
Hanging bucket package

Codice	Fissaggio / Fixing	mm	Foro / Hole Ø mm	📦	Barcode
610045	Pesante / Heavy	6 x 55	14	50	8033183591128
610046	Pesante / Heavy	8 x 70	16	50	8033183591012
610047	Pesante / Heavy	10 x 80	18	50	8033183591135



610023 TASSELLI AD ANCORA CON VITE

ANCHOR DOWELS WITH SCREW

- ♦ Espansione automatica a molla per cavità poco profonde
Automatic spring expansion for shallow cavities
- ♦ Cunei antirotazione all'estremità della molla per un aggrappo stabile
Anti-rotation wedges at the end of the spring for a stable grip
- ♦ Vite a testa combinata M4 zincata bianca + rondella metallica
White zinc-plated M4 combination head screw + metal washer
- ♦ Confezione secchiello appendibile
Hanging bucket package

Codice	Fissaggio / Fixing	mm	Vite / Lives	📦	Barcode
610023	Leggero / Light	80	M4	100	8033183575067



610025 TASSELLI AD ANCORA CON OCCHIELLO CHIUSO
ANCHOR DOWELS WITH CLOSED EYELET

- Espansione automatica a molla per cavita' poco profonde
Automatic spring expansion for shallow cavities
- Cunei antirotazione all'estremità della molla per un aggrappo stabile
Anti-rotation wedges at the end of the spring for a stable grip
- Gancio ad occhio chiuso + rotella metallica
Closed eye hook + metal roller
- Confezione secchiello appendibile
Hanging bucket package

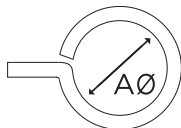



Codice	Fissaggio / Fixing	mm	A mm		Barcode
610025	Leggero / Light	75	15	100	8033183575074

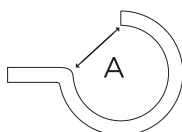

610026 TASSELLI AD ANCORA CON OCCHIELLO APERTO
ANCHOR DOWELS WITH OPEN EYELET

- Espansione automatica a molla per cavita' poco profonde
Automatic spring expansion for shallow cavities
- Cunei antirotazione all'estremità della molla per un aggrappo stabile
Anti-rotation wedges at the end of the spring for a stable grip
- Gancio ad occhio aperto + rotella metallica
Open eye hook + metal roller
- Confezione secchiello appendibile
Hanging bucket package



Codice	Fissaggio / Fixing	mm	A mm		Barcode
610026	Leggero / Light	75	15	100	8033183575081



Tasselli per idrotermosanitaria

Dowels for plumbing and heating

610048 TASSELLI PER FISSAGGIO SANITARI PLUGS FOR SANITARY FIXING

- Corpo in nylon
Nylon body
- Vite TE in acciaio zincato
TE screw in galvanized steel
- Ancorante per il fissaggio di staffe di supporto per apparecchi sanitari e di condizionamento
Anchor for fixing support brackets for appliances sanitary and air conditioning
- Confezione secchiello appendibile
Hanging bucket package



Codice	Fissaggio / Fixing	B1 x C1 mm	Vite / Lives		Barcode
610048	Leggero / Light	12 x 80	M8 x 80	100	8033183594051
610049	Leggero / Light	14 x 80	M10 x 90	100	8033183594068

610050 COLLARE PER FISSAGGIO TUBI COLLAR FOR PIPE FIXING

- In acciaio ad alta resistenza con dado elettrosaldato
In high resistance steel with electro-welded nut
- Viteria in acciaio inox
Stainless steel screws
- Completo di tassello in nylon e controdado
Complete with nylon plug and counter
- Confezione sacchetto da 2 pezzi:
Packaging bag of 2 pieces:
 - 2x collari / Collars
 - 2x collari con dado / Collars with nut
 - 2x viti filetto doppio / Double thread screws
 - 4x viti combinate / Combined screws
 - 2x tasselli / Dowels
 - 2x controdadi / Locknuts

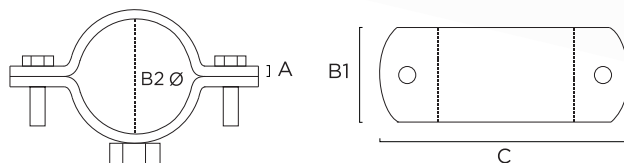
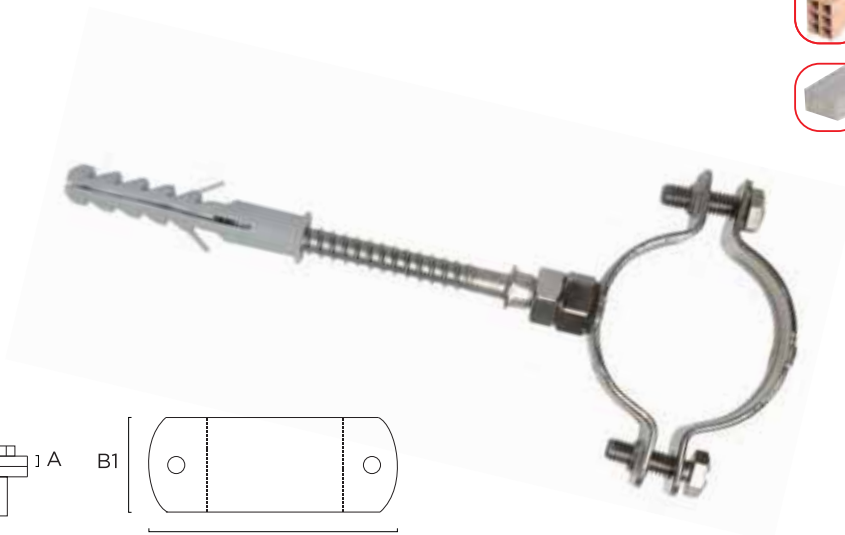

Codice	B2 Pollici/Inch	B2 mm	B1 x C x A mm	Vite / Lives	Tassello / Gusset	pz. conf. / pcs pack.		Barcode
610050	3/8"	16 - 18	20 x 52 x 1,6	M8 x 90	10 x 50	2	50	8033183594457
610051	1/2"	20 - 24	20 x 58 x 2,0	M8 x 90	10 x 50	2	50	8033183594464
610052	3/4"	25 - 30	20 x 65 x 2,0	M8 x 90	10 x 50	2	50	8033183594471
610053	1"	32 - 26	20 x 71 x 2,0	M8 x 90	10 x 50	2	50	8033183594488
610054	1¼"	38 - 44	20 x 83 x 2,0	M8 x 90	10 x 50	2	50	8033183594495
610055	1½"	46 - 50	20 x 85 x 2,0	M8 x 90	10 x 50	2	50	8033183594501
610056	2"	58 - 62	20 x 98 x 2,0	M8 x 90	10 x 50	2	30	8033183594518
610057	2½"	74 - 80	30 x 130 x 2,0	M10 x 120	12 x 60	2	30	8033183594525
610058	3"	84 - 89	30 x 142 x 2,0	M10 x 120	12 x 60	2	30	8033183594532
610059	4"	112 - 118	30 x 168 x 2,0	M10 x 120	12 x 60	2	24	8033183594549

610060 SET FISSAGGI INSTALLAZIONI VERTICALI PER VASI E BIDET FIXING SET FOR VERTICAL INSTALLATIONS FOR TOILETS AND BIDETS

- La boccola in nylon impedisce il contatto tra vite e sanitario
The nylon bushing prevents contact between screw and sanitary
- Vite doppio filetto in acciaio
Double thread steel screw
- Completo di tassello in nylon e dado a testa bombata
Complete with nylon plug and rounded head nut
- Confezione sacchetto:
Bag packaging:
 - 4x viti filetto doppio / *Double thread screws*
 - 4x boccole / *Bushings*
 - 4x tasselli / *Dowels*
 - 4x dadi ciechi / *Blind dice*



Codice	Vite / Lives	Tassello / Gusset	📦	Barcode
610060	M6 x 80 Acciaio / Steel	8 x 40	25	8033183594556
610061	M6 x 80 Acc. inox / Stainless steel	8 x 40	25	8033183594563
610062	M6 x 80 Ottone / Brass	8 x 40	25	8033183594570

Codice	Vite / Lives	Tassello / Gusset	📦	Barcode
610063	M6 x 90 Ottone / Brass	8 x 40	25	8033183594587
610064	M6 x 90 Acciaio / Steel	8 x 40	25	8033183594594

610066 SET FISSAGGI CASSETTE WC WC CASSETTE FIXING SET

- La boccola in nylon impedisce il contatto tra vite e sanitario
The nylon bushing prevents contact between screw and sanitary
- Vite doppio filetto in acciaio
Double thread steel screw
- Completo di tassello in nylon e dado in acciaio
Complete with nylon plug and steel nut
- Confezione sacchetto:
Bag packaging:
 - 2x viti filetto doppio / *Double thread screws*
 - 2x boccole / *Bushings*
 - 2x tasselli / *Dowels*
 - 2x dadi / *Dice*



Codice	Vite / Lives	Tassello / Gusset	📦	Barcode
610066	Per WC / WC	M8 x 90	10 x 50	25 8033183594617
610067	Per lavabi / Washbasins	M10 x 120	12 x 60	25 8033183594624
610068	Per lavabi / Washbasins	M10 x 140	12 x 60	25 8033183594631

Codice	Vite / Lives	Tassello / Gusset	📦	Barcode
610069	Per lavabi / Washbasins	M10 x 180	12 x 60	25 8033183594648
610070	Per lavabi / Washbasins	M10 x 220	12 x 60	25 8033183594655

610065 SET FISSAGGI INSTALLAZIONI A PARETE PER VASI E BIDET LATERALI WALL FIXING SET FOR SIDE TOILETS AND BIDETS

- Staffa angolare in acciaio con rivestimento plastico
Angular bracket in steel with plastic coating
- La boccola in nylon impedisce il contatto tra vite e sanitario
The nylon bushing prevents contact between screw and sanitary
- Completo di tassello in nylon e viti in acciaio + rondella metallica
Complete with nylon plug and steel screws + metal washer
- Confezione sacchetto:
Bag packaging:
 - 2x fissaggi a L / "L" shaped fixings
 - 2x copriviti / Screw covers
 - 2x tasselli / Dowels
 - 4x viti / Screws
 - 2x rondelle / Washers
 - 2x boccole / Bushings



Codice	Foro / Hole ø mm	Tassello / Gusset	📦	Barcode
610065	10	10 x 50	25	8033183594600

610071 TASSELLI CON VITE GANCIO PER SCALADABAGNI A PARETE DOWELS WITH SCREW HOOK FOR WALL-MOUNTED WATER HEATER

- ♦ Corpo in nylon a 4 settori che permette una perfetta aderenza ed una portata superiore
4 sector nylon body that allows a perfect fit and a higher range
- ♦ L'espansione sui 4 lati permette una perfetta aderenza
The expansion on the 4 sides allows a perfect fit
- ♦ Viti a gancio per il fissaggio di caldaie, scaldabagni e cassette
Hook screws for fastening boilers, water heaters and cisterns
- ♦ Confezione sacchetto
Bag packaging

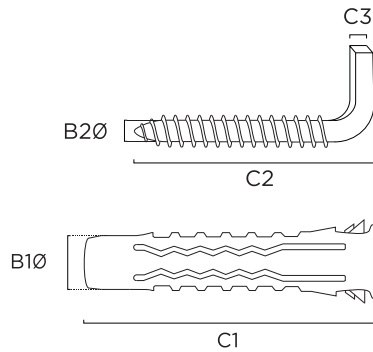

Codice	B2 x C2 mm	C3 mm	B1 x C1 mm	📦	Barcode
610071	10 x 70	4	10 x 50	25	8033183594662
610072	10 x 80	4	12 x 60	25	8033183594679
610073	10 x 100	4	12 x 60	25	8033183594686
610074	10 x 120	4	12 x 60	25	8033183594693

610077 COPPIA MENSOLE TONDE PER RADIATORI PAIR OF ROUND BRACKETS FOR RADIATORS

- ♦ Corpo in ferro a sezione tonda verniciato bianco
White painted round section iron body
- ♦ Complete di tasselli in nylon per il fissaggio a muro
Complete with nylon plugs for fixing to the wall
- ♦ Confezione sacchetto:
Bag packaging:
 - 2x mensole tonde / *Round shelves*
 - 2x tasselli / *Dowels*

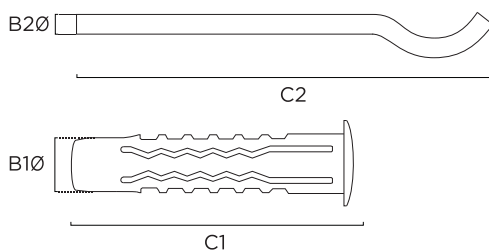

Codice	B2 x C2 mm	B1 x C1 mm	📦	Barcode
610077	7 x 170	10 x 80	30	8033183594723
610078	9 x 170	12 x 80	30	8033183594730
610079	12 x 230	16 x 90	15	8033183594747
610080	12 x 260	16 x 90	15	8033183594754

610075 COPPIA MENSOLE PIATTE PER RADIATORI PAIR OF FLAT BRACKETS FOR RADIATORS

- ♦ Corpo in ferro a sezione piatta verniciato bianco
White painted flat section iron body
- ♦ Complete di tasselli in nylon per il fissaggio a muro
Complete with nylon plugs for fixing to the wall
- ♦ Confezione sacchetto:
Bag packaging:
 - 2x mensole piatte / *Flat shelves*
 - 2x tasselli / *Dowels*

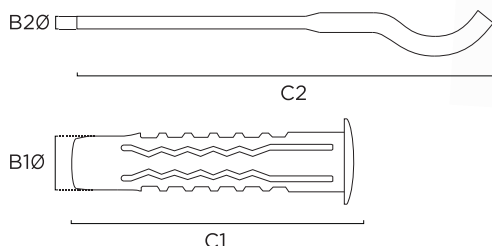

Codice	B2 x C2 mm	B1 x C1 mm		Barcode
610075	7 x 170	10 x 80	30	8033183594709
610076	9 x 170	12 x 80	30	8033183594716

610081 COPPIA STAFFE PER PILOZZI PAIR OF BRACKETS FOR WASHBASIN

- ♦ Corpo in ferro a sezione tonda verniciato bianco
White paint
- ♦ Complete di tasselli in nylon per il fissaggio a muro
Complete with nylon plugs for fixing to the wall
- ♦ Confezione sacchetto:
Bag packaging:
 - 2x mensole / *Shelves*
 - 2x tasselli / *Dowels*
 - 2x dadi / *Dice*
 - 2x viti / *Screws*
 - 2x rondelle metalliche / *Metal washers*

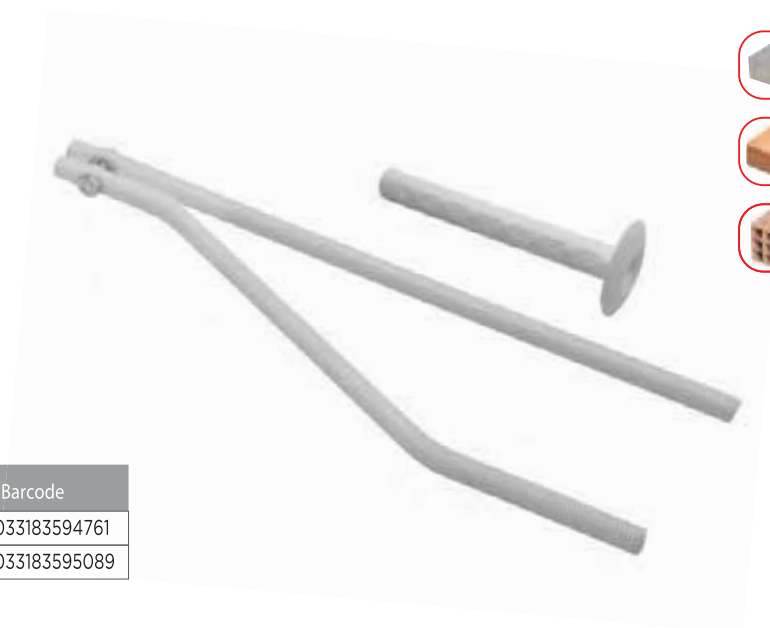

Codice	B2 x C2 mm	B1 x C1 mm		Barcode
610081	12 x 340	16 x 90	10	8033183594761
610082	12 x 460	16 x 90	10	8033183595089

ATTREZZI SEMPRE A PORTATA DI MANO

TOOLS ALWAYS AT HAND



13



LINEA PRO
PRO LINE

288 Valigie portautensili
Tool cases

291 Borse portautensili
Tool bags

296 Cassette portautensili
Tool boxes

PORTAUTENSILI PRATICI PRACTICAL TOOL HOLDERS

Spazi di costruzione stretti e lavori che cambiano frequentemente, costringono il lavoratore ad organizzarsi nell'aver l'attrezzatura sempre a portata di mano; per questo Fumasi propone una vasta gamma di portattrezzi pratici e comodi, adattabili ad ogni possibile ambito di lavoro.

Narrow construction spaces and jobs that change frequently force the worker to organize themselves in having the equipment always at hand; for this Fumasi offers a wide range of practical and comfortable tool holders, adaptable to every possible field of work.



VALIGE PORTAUTENSILI
TOOL CASES



BORSE PORTAUTENSILI
TOOL BAGS



CASSETTE PORTAUTENSILI
TOOL BOXES

CARRELLI PORTAUTENSILI TOOL TROLLEYS

Carrelli portautensili e banchi da lavoro sono aiutanti indispensabili in officina e nell'ambito industriale. Hanno corpi in lamiera di acciaio di particolare spessore, e sono caratterizzati da una verniciatura a polvere antigraffio che li rende ancora più robusti. Cassetti, contenitori con scomparti, ruote fisse e girevoli, consentono flessibilità e velocità nei lavori di tutti i giorni.

Tool trolleys and workbenches are essential helpers in the workshop and in the industrial sector.

They have particularly thick steel sheet bodies, and are characterized by a scratch-resistant powder coating that makes them even more robust.

Drawers, containers with compartments, fixed and swiveling wheels, allow flexibility and speed in everyday work.



SOLUZIONI ESPOSITIVE EXHIBITION SOLUTIONS

Fumasi fornisce sistemi espositivi che esaltino il valore e le caratteristiche degli articoli.

Una semplice soluzione che diventa un ottimo strumento pratico e funzionale per un migliore posizionamento del prodotto sul mercato.

We can supply display systems that enhance the value and characteristics of the items.

A simple solution that becomes an excellent practical and functional tool for a better positioning of the product on the market.



13

Portautensili pratici Practical tool holders

Valigie portautensili Tool cases

100721 VALIGIA IN ABS ABS CASE

- Struttura in ABS antiurto termoformato
Shockproof thermoformed ABS structure
- Maniglia in ABS con impugnatura morbida
ABS handle with soft grip
- Profilo in alluminio piegato a freddo
Cold bent aluminum profile
- Con 1 pannello completo di elastici, tasche porta pinze e documenti e vasca con divisori modulari
With 1 panels complete with elastic, pockets for pliers and documents and bathtub with modular dividers
- Serrature con chiusura a chiave in metallo
Locks with key lock in meta

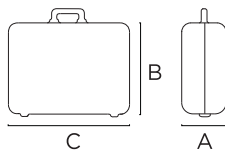

Codice	C x B x A mm	gr		Barcode
100721	480 x 380 x 255	4300	1	8033183551160



100722 VALIGIA IN ALLUMINIO ALUMINUM CASE

- Calotta in alluminio accoppiato a multistrato fenolico
Shell in aluminum coupled with phenolic multilayer
- Maniglia cromata con impugnatura morbida
Chrome handle with soft grip
- Fondo provvisto di divisori amovibili
Bottom equipped with removable dividers
- Con 2 pannelli in polistirolo completi di elastici, tasca porta documenti e vasca in ABS termoformato
With 2 polystyrene panels complete with elastics, document pocket and tub in thermoformed ABS
- Serrature con chiusura a chiave in acciaio cromato
Locks with key in chromed steel

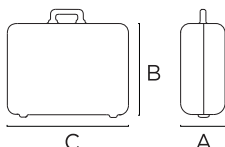

Codice	C x B x A mm	gr		Barcode
100722	480 x 390 x 200	7000	1	8033183556837



100719 VALIGIA ANTIGRAFFIO SCRATCH-PROOF SUITCASE

- Struttura in alluminio con trattamento antigraffio che la rende ideale per l'uso quotidiano.
Il nuovo design della calotta conferisce un look moderno e attraente
*Aluminum structure with anti-scratch treatment which makes it ideal for daily use.
The new shell design gives it a modern and attractive look*
- Con 2 pannelli completi di elastici e tasche porta pinze e documenti
With 2 panels complete with elastic and pocket for pliers and documents
- 2 Serrature con chiusura a chiave e 2 cerniere posteriori che fungono da supporto per il coperchio e da piedini
2 locks with key lock and 2 rear hinges which act as a support for the lid and as feet

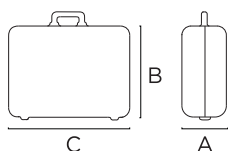

Codice	C x B x A mm	gr		Barcode
100719	470 x 350 x 185	5000	1	8033183845795



101420 VALIGIA IN ALLUMINIO ALUMINUM CASE

Valigia di alta qualità una delle migliori tra i modelli professionali
High quality suitcase one of the best among the professional models

- Struttura in alluminio + polipropilene
Structure in aluminum + polypropylene
- Maniglia cromata con impugnatura morbida
Chrome handle with soft grip
- Accessori di rinforzo in acciaio cromato, profili rivettati, robuste cerniere in acciaio cromato con perno di sostegno all'apertura
Reinforcement accessories in chromed steel, riveted profiles, robust chromed steel hinges with support pin for opening
- Con 2 pannelli completi di elastici, tasca porta pinze e documenti
vasca in ABS termoformato e doppio portaminuteria
With 2 panels complete with elastic, pocket for pliers and documents thermoformed ABS tank and double small parts holder
- Serrature con chiusura a chiave in acciaio cromato
Locks with key in chromed steel

TIPO TROLLEY

101420T VALIGIA TROLLEY A TRASPORTO VERTICALE VERTICAL TROLLEY CASE

- La versione TROLLEY prevede:
 - 1 maniglia telescopica in alluminio con manico in plastica
 - 2 ruote robuste in plastica robusta per garantire una maggior stabilità e scorrevolezza
- The TROLLEY version includes:*
- 1 telescopic aluminum handle with plastic handle
 - 2 strong wheels made of sturdy plastic to ensure one greater stability and smoothness



Codice	C x B x A mm	gr		Barcode	
101420	480 x 390 x 200	7000	1	8033183551177	
101420T	Trolley / Trolley	480 x 390 x 200	8500	1	8033183589972





101402 VALIGIA IN ALLUMINIO ALUMINUM CASE

Valigia classica a forma squadrata con importanti rinforzi in alluminio estruso rivettati e profili di protezione in acciaio cromato con particolari angolature sferiche

Classic square-shaped suitcase with special aluminum reinforcements on the profiles and metal protections.

- ♦ Struttura in alluminio + polipropilene
Structure in aluminum + polypropylene
- ♦ Maniglia cromata con impugnatura morbida
Chrome handle with soft grip
- ♦ Accessori di rinforzo in acciaio cromato, angoli rinforzati, fascette parasigoli e robuste cerniere con perno di sostegno
Reinforcement accessories in chromed steel, reinforced corners, clamps edge protectors and sturdy hinges with support pin
- ♦ Con 2 pannelli completi di elastici, tasca porta pinze e documenti vasca in ABS termoformato e doppio portaminuteria
With 2 panels complete with elastic, pocket for pliers and documents thermoformed ABS tank and double small parts holder

TIPO TROLLEY

101402T VALIGIA TROLLEY A TRASPORTO VERTICALE VERTICAL TROLLEY CASE

- ♦ La versione TROLLEY prevede:
 - 1 maniglia telescopica in alluminio con manico in plastica
 - 2 ruote robuste in plastica resistente per garantire una maggior stabilità e scorrevolezza
- The TROLLEY version includes:*
- 1 telescopic aluminum handle with plastic handle
 - 2 strong wheels made of sturdy plastic to ensure one greater stability and smoothness



Codice		C x B x A mm	gr		Barcode
101402		440 x 330 x 170	6500	1	8033183551108
101402T	Trolley / Trolley	440 x 330 x 170	8200	1	8033183589989

100726 VALIGIA TROLLEY A TRASPORTO VERTICALE VERTICAL TROLLEY CASE

- ♦ Struttura in ABS antiurto
Shockproof ABS structure
- ♦ Maniglia telescopica in ABS
Telescopic handle in ABS
- ♦ Con 2 pannelli completi di elastici, tasca porta pinze e documenti e vasca con divisori removibili
With 2 panels complete with elastic, pocket for pliers and documents and tub with removable dividers
- ♦ Serratura con combinazione a 3 cifre
3 digit combination lock
- ♦ 2 ruote robuste con cuscinetti a sfera
2 sturdy wheels with ball bearings

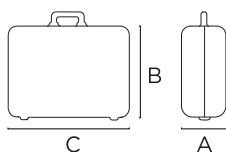

Codice		C x B x A mm	gr		Barcode
100726		439 x 312 x 200	4000	1	8033183554246



100720 VALIGIA IN POLIPROPILENE POLYPROPYLENE CASE

- ♦ Struttura in polipropilene stampato ad iniezione, che garantisce un'ottima resistenza agli urti e alle alte e basse temperature e profilo in robusto alluminio
Injection-molded polypropylene structure, which guarantees excellent resistance to shocks and high and low temperatures and sturdy aluminum profile
- ♦ Con 2 pannelli completi di elastici e tasche porta pinze e documenti
With 2 panels complete with elastic and pocket for pliers and documents
- ♦ Maniglia ergonomica con grip in gomma
ABS handle with soft grip
- ♦ 2 Serrature con chiusura a chiave e 3 cerniere posteriori per una massima tenuta
2 locks with key lock and 3 rear hinges for one maximum hold

TIPO TROLLEY

100720T VALIGIA TROLLEY A TRASPORTO ORIZZONTALE HORIZONTAL TROLLEY CASE

- ♦ La versione TROLLEY prevede:
 - 1 maniglia telescopica in alluminio con manico in plastica
 - 2 ruote robuste in plastica resistente per garantire una maggior stabilità e scorrevolezza
- The TROLLEY version includes:*
- 1 telescopic aluminum handle with plastic handle
 - 2 strong wheels made of sturdy plastic to ensure one greater stability and smoothness



Codice		C x B x A mm	gr		Barcode
100720		445 x 315 x 198	4100	1	8033183845832
100720T	Trolley / Trolley	445 x 315 x 198	5600	1	xx

Borse portautensili Tool bags

100424 BORSA PORTA ATTREZZI IN TESSUTO TOOL BAG IN FABRIC

- ♦ Borsa realizzata in un tessuto di poliestere molto resistente con tracolla removibile e regolabile che garantisce il massimo comfort durante l'uso
Bag made of a very resistant polyester fabric with removable and adjustable shoulder strap that guarantees maximum comfort during use
- ♦ Tasche interne ed esterne che la rendono spaziosa e facile da ordinare e un cassetto portaminuteria
Internal and external pockets that make it spacious and easy to order and a small parts drawer
- ♦ Maniglia in metallo antiscivolo imbottita con morbida spugna
Non-slip metal handle padded with soft sponge
- ♦ Con tappetino poggia ginocchio
With knee pad
- ♦ Chiusura tramite velcro
Velcro closure



Codice		mm	gr		Barcode
100424		420 x 240 x 260	1700	1	8033183559104

100425 BORSA PORTA ATTREZZI IN TESSUTO TOOL BAG IN FABRIC

- Borsa realizzata in un tessuto di poliestere molto resistente con tracolla removibile e regolabile che garantisce il massimo comfort durante l'uso
Bag made of a very resistant polyester fabric with removable and adjustable shoulder strap that guarantees maximum comfort during use
- Tasche interne ed esterne che la rendono spaziosa e facile da ordinare
Internal and external pockets that make it spacious and easy to order
- Maniglia in metallo antiscivolo imbottita con morbida spugna
Non-slip metal handle padded with soft sponge
- Con tappetino poggia ginocchio
With knee pad
- Chiusura tramite velcro
Velcro closure

Codice	mm	gr		Barcode
100425	420 x 260 x 300	2000	1	8033183557414



153502 BORSA MULTIFUNZIONE TIPO PILOTA PILOT-TYPE MULTIFUNCTIONAL BAG

- Borsa multifunzione ad accesso verticale con tracolla regolabile che garantisce il massimo comfort durante l'uso
Vertical access multifunction bag with adjustable shoulder strap which guarantees maximum comfort during use
- Composta da elastici, tasche frontali e posteriori porta utensili e compartimento porta PC (per PC fino a 15.6")
Composed of elastics, front and rear tool pockets and PC compartment (for PC up to 15.6")
- Compartimento frontale removibile, convertibile in borse porta utensili
Removable front compartment, convertible into tool bags
- Chiusura tramite zip
Zip closure

Codice	mm	gr		Barcode
153502	420 x 360 x 205	1100	1	8033183590022



100426 BORSA PORTA ATTREZZI TOOL BAG

- Borsa porta attrezzi con tracolla regolabile che garantisce il massimo comfort durante l'uso
Tool bag with adjustable shoulder strap that guarantees maximum comfort during use
- Composta da tasche imbottite e manici per il trasporto a mano che vedono la presenza di una morbida impugnatura
Composed of padded pockets and handles for carrying by hand that see the presence of a soft handle
- Chiusura tramite zip
Zip closure
- Resistente fondo anti urto
Resistant shockproof bottom

Codice	mm	gr		Barcode
100426	410 x 300 x 230	1300	1	8033183590022



100422 BORSA COMPACT PORTA UTENSILI COMPACT TOOL BAG

- Realizzata in tessuto di nylon resistente e idrorepellente
Made of durable, water-repellent nylon fabric
- 2 pannelli removibili porta utensili e 2 cassettoni portaminuteria posti all'interno delle tasche laterali
2 removable tool holder panels and 2 small parts drawers placed inside the side pockets
- Tracolla regolabile con imbottitura che garantisce il massimo comfort durante l'uso
Adjustable shoulder strap with padding that guarantees maximum comfort during use

Codice	mm	gr		Barcode
100422	300 x 120 x 320	1300	1	8033183554017



100423 TASCA PORTA UTENSILI DA CINTURA BELT TOOL POCKET

- Realizzata in robusto e impermeabile tessuto antistrappo
Made of sturdy and waterproof tear-resistant fabric
- Dotata di 2 barre porta utensili estraibili, 1 porta flessometro a gancio e 1 aggancio per nastro isolante
Equipped with 2 extractable tool bars, 1 measuring tape holder hook and 1 hook for insulating tape
- Adattabile a qualsiasi tipo di cintura
Adaptable to any type of belt
- Cintura regolabile inclusa solo con art. 100424C
Adjustable belt included only with art. 100424C

Codice	mm	gr		Barcode	
100423	220 x 300 x 25	550	2	8033183553973	
100424C	Con cintura / With belt	220 x 300 x 25	550	2	8033183561695



100428 ZAINETTO PORTA UTENSILI TOOL HOLDER BACKPACK

- Realizzato in tessuto antistrappo, idrorepellente, resistente al calore e agli agenti chimici, con fondo e cuciture rinforzati
Made of tear-resistant, water-repellent, resistant fabric to heat and chemicals, with reinforced bottom and seams
- Tascone interno avvolgibile adatto a qualsiasi tipo di utensile, tasche interne ed esterne di varie dimensioni ideali per trasportare utensili, accessori e documenti
Internal roll-up pocket suitable for any type of tool, pockets internal and external of various sizes ideal for transporting tools, accessories and documents
- Chiusura tramite zip
Zip closure
- Spallacci imbottiti e regolabili che assicurano un agevole trasporto
Padded and adjustable shoulder straps that ensure easy transport

Codice	mm	gr		Barcode
100428	310 x 120 x 390	800	1	8033183845801





100429 ZAINETTO TROLLEY MULTIFUNZIONE MULTIFUNCTION TROLLEY BACKPACK

- Realizzato in tessuto di nylon resistente e idrorepellente
Made of durable, water-repellent nylon fabric
- Tasca frontale con elastici porta penne e porta documenti, lato interno con tasche ed elastici fissi
Front pocket with elastic pen holder and document holder, side interior with pockets and fixed elastics
- Pannello interno porta utensili estraibile con tasche ed elastici su entrambi i lati
Removable internal tool holder panel with pockets and elastics on both sides
- Chiusura tramite zip
Zip closure
- Spallacci imbottiti e regolabili che assicurano un agevole trasporto
Padded and adjustable shoulder straps that ensure easy transport
- Protezione per le ruote in caso di utilizzo a spalla
Protection for the wheels in case of shoulder use

Codice	mm	gr		Barcode
100429	310 x 480 x 190	2000	1	8033183590039



100472V TROUSSE PER CARTONGESSISTI E MURATORI TROUSSE FOR PLASTER WORKERS AND MASONERS

- Realizzata in tessuto impermeabile, resistente all'abrasione e ai graffi per una lunga durata
Made of waterproof, abrasion resistant and fabric to scratches, with a long service life
- La borsa presenta 2 tasche richiudibili tramite velcro realizzate in doppio strato di tessuto di nylon di alta qualità e 4 tasche di inserimento
The bag has 2 pockets that can be closed with velcro made of double layer of high quality nylon fabric and 4 insertion pockets
- Cintura regolabile in tessuto ad alta resistenza
Adjustable belt in highly resistant fabric

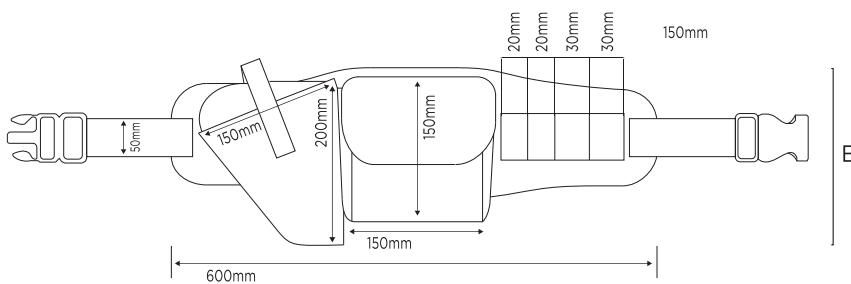

C

Codice	C (Min) x B mm	C (Max) x B mm	gr		Barcode
100472V	750 x 210	1200 x 210	100	1	8033183846815

100470V TROUSSE IN NYLON ROSSA
TROUSSE IN RED NYLON

- Realizzata in tessuto di nylon impermeabile, resistente all'abrasione e ai graffi per una lunga durata
Made of waterproof nylon fabric, resistant to abrasion and scratches, with a long service life
- 3 tasche di inserimento e 2 tasche portautensili
3 insertion pockets and 2 tool pockets
- Aletta di chiusura richiudibile tramite velcro
Closing flap closable with velcro
- Sistema di fissaggio tramite gancio in metallo
Fastening system with metal hook

Codice	mm		Barcode
100470V	200 X 125	1	8033183837813



100450V TROUSSE DA CINTURA IN CORDURA NERA
BELT TROUSSE IN BLACK CORDURA

- Realizzata in cordura impermeabile dall'elevata robustezza, flessibilità e resistenza all'usura nel tempo e resistente all'abrasione
Made of highly robust waterproof cordura, flexibility and resistance to wear over time and resistant to abrasion
- Classica forma a tasca con aletta di chiusura richiudibile tramite bottone a pressione
Classic pocket shape with closing flap that can be closed with pressure button
- Per cintura
For belt

Codice	mm		Barcode
100450V	200 X 90	1	8033183845849



102600V TROUSSE IN TESSUTO ROSSA
RED FABRIC TOOL BAG

- Realizzata in tessuto satinato impermeabile, lavabile e resistente
Made of waterproof, washable and resistant satin fabric
- Unica tasca con chiusura a cerniera
One pocket with zip closure
- Per cintura
For belt

Codice	mm		Barcode
102600V	250 x 105	1	8033183845856



Cassette portautensili

Tool boxes

870501 CASSETTA PORTA ATTREZZI IN LAMIERA SHEET METAL TOOL BOX

- Struttura in lamiera verniciata a polvere epossidica con un'elevata durezza e alta capacità di carico, connettori in metallo che collegano i vassoi ripiegabili
Structure in epoxy powder coated sheet with a high hardness and high load capacity, metal connectors connecting the foldable trays
- Contenitori ripiegabili su ogni lato e uno grande centrale con coperchio
Containers foldable on each side and a large central one with lid
- Maniglia grande centrale che permette un facile trasporto
Large central handle that allows easy transport

Codice	Scomparti / Compartments	C x B1 x A mm	B2 mm	gr		Barcode
870101	2	450 x 210 x 100	120	2200	1	8033183550859
870301	3	450 x 210 x 160	120	3000	1	8033183550866
870501	5	550 x 210 x 210	120	5000	1	8033183550873
870501P	5	450 x 210 x 210	120	4000	1	8033183557896

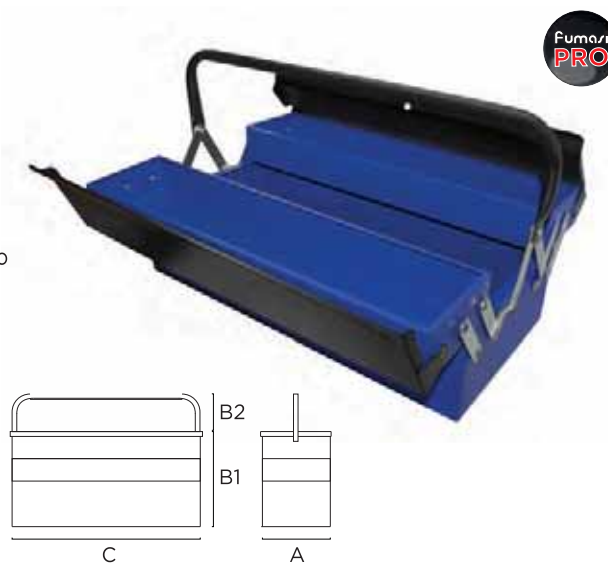

870701 CASSETTA PORTA ATTREZZI IN POLIPROPILENE TOOL BOX IN POLYPROPYLENE

- Struttura in resistente polipropilene indeformabile, infrangibile, antiruggine e antiurto
Structure in resistant non-deformable, unbreakable polypropylene, rustproof and shockproof
- Maniglia ergonomica a scomparsa, robusta e confortevole
Robust and comfortable retractable ergonomic handle
- Ampio vano portautensili con vaschetta estraibile e 2 vaschette portaminuteria fisse sul coperchio
Large tool compartment with removable tray and 2 trays small parts holders fixed on the lid
- Chiusure a scatto
Snap closures

Codice		mm	gr		Barcode
870703	Piccola / Small	300 x 140 x 120	800	5	8033183555281
870702	Media / Medium	400 x 200 x 200	1200	5	8033183555274
870701	Grande / Big	500 x 270 x 260	2000	5	8033183552075



870801 VALIGETTA PORTAMINUTERIA IN POLIPROPILENE POLYPROPYLENE CASE

- Struttura in resistente polipropilene indeformabile, infrangibile, antiruggine e antiurto con coperchio trasparente e chiusura a scatto
Structure in resistant non-deformable, unbreakable polypropylene, rustproof and shockproof with transparent lid with snap closure
- Vaschette portaminuteria estraibili
Removable small parts trays
- Modello sovrapponibile grazie al bordino rialzato sul coperchio
Stackable model thanks to the raised edge on the lid

Codice		mm	gr		Barcode
870801		420 x 330 x 60	1100	5	8033183552761



COLLEGAMENTO FACILE E VELOCE

FAST AND EASY CONNECTION

Particolari cassette portautensili con un innovativo sistema di aggancio che le rendono un partner insostituibile nel lavoro, la fessura laterale consente di sovrapporle una sull'altra, rendendo tutto più ordinato e sicuro.

La possibilità di scegliere tra tre diverse altezze rendono le cassette anche estremamente versatili ed in grado di rispondere ad ogni specifica esigenza.

Special toolboxes with an innovative coupling system that make them an irreplaceable partner for work, side stacking allows you to stack them on top of each other, making everything tidier and safer.

The possibility to choose between three different heights also make the cassettes extremely versatile and able to respond to every specific need.

870704 VALIGIA TECNICA COMPLETA COMPLETE TECHNICAL SUITCASE

- Cassetta in ABS professionale modulare estremamente robusta, antipioggia e antipolvere con aggancio laterale

Professional modular ABS box with patented lateral coupling which allows you to superimpose one cassette on top of another, creating a "system"

- Speciale aggancio che consente di sovrapporre una cassetta sull'altra

Special coupling that allows you to superimpose one cassette on top of another

- Con carrello

With cart



- 1 **870704P** Valigia portautensili tecnica misura piccola

Small technical tool case



- 2 **870704G** Valigia portautensili tecnica misura media

Medium technical tool case



- 3 **870704PE** Valigia portautensili tecnica misura grande

Big technical tool case



Codice		C x A x B mm		Barcode
870704	Valigia completa + carrello / Complete suitcase + cart	465 x 345 x 820	1	8033183571182
870704P	Valigia piccola / Small suitcase	465 x 345 x 140	1	8033183568373
870704G	Valigia media / Medium suitcase	465 x 345 x 210	1	8033183568380
870704PE	Valigia grande / Big suitcase	465 x 345 x 360	1	8033183568397
870704C	Carrello / Cart		1	8033183571199

L'ORGANIZZAZIONE INTELLIGENTE

THE INTELLIGENT ORGANIZATION



13



LINEA PRO
PRO LINE

299 Carrelli portautensili
Tool trolleys

307 Soluzioni espositive
Display solutions

Carrelli portautensili

Tool trolleys

- 1** **Struttura robusta in lamiera con superficie verniciata a polvere** che lo rende meno predisposto ai graffi e alla corrosione.
Sturdy sheet metal structure with a powder coated surface covering it makes it less prone to scratches and corrosion.
- 2** **Quattro stabili ruote** ne consentono l'uso in movimento e facilitano le manovre, con freni di stazionamento.
Four stable wheels allow it to be used on the move and facilitate maneuvers, with parking brakes.
- 3** **Guide di scorrimento con cuscinetti ad alta resistenza.**
Sliding guides with high resistance bearings.

881101 CARRELLO DA OFFICINA WORKSHOP TROLLEY



- Piano di lavoro con gomma antiscivolo, apribile su guida a cuscinetti a sfere, cassetina scorrevole interna, 1 cassetto apribile esterno e 12 scomparti
Worktop with non-slip rubber, which can be opened on a guide ball bearings, internal sliding box, 1 drawer external opening and 12 compartments
- 2 ruote girevoli e 2 con freno
2 swivel wheels and 2 with brake
- Maniglia per un semplice trasporto
Handle for easy transport

Codice	Portata statica / Static flow rate (Kg)	mm	kg		Barcode
881101	210	820 x 795 x 530	14	1	8033183550774



881105 CARRELLO DA OFFICINA WORKSHOP TROLLEY

- 3 grandi superfici di carico fisse con bordo
3 large fixed loading surfaces with edge
- 2 ruote girevoli e 2 con freno
2 swivel wheels and 2 with brake
- Maniglia per un semplice trasporto
Handle for easy transport

Codice		Portata statica / Static flow rate (Kg)	Ruote / Tire \varnothing mm	mm	kg		Barcode
881105		210	100	820 x 780 x 425	22	1	8033183564870
881106		240	125	900 x 920 x 600	37	1	8033183590107





886001 CARRELLO PORTAUTENSILI TOOL HOLDER TROLLEY

- 7 cassetti ad angoli arrotondati (5 piccoli, 1 medio, 1 grande) richiudibili su cuscinetti a sfere e piano in ABS goffrato
7 drawers with rounded corners (5 small, 1 medium, 1 large) reclosable on ball bearings and embossed ABS top
- Fianchi rientranti con foratura quadrata per applicazione di ganci
Recessed sides with square perforation for the application of hooks
- Dotato di serratura che impedisce l'apertura indesiderata durante il trasporto e l'accesso non autorizzato
Equipped with a lock that prevents unwanted opening during transport and unauthorized access
- Munito di inserti filettati, per un montaggio facile e veloce
Equipped with threaded inserts, for quick and easy assembly
- Maniglia reversibile destra / sinistra
Right / left reversible handle
- Disponibili su richiesta una vasta gamma di accessori
A wide range of accessories available on request



- 1** 888001T Tappeto di gomma espansa per cassetti
Expanded rubber mat for drawers



- 2** 88801DF 2 divisori in ferro per cassetto
2 dividers on the back per drawer



- 3** 881801PB Porta barattoli
Jar holder



- 4** 881801PC Porta carta
Paper holder



Foratura quadrata: 10 x 10 mm
Passo: 38 x 38 mm
*Square hole: 10 x 10 mm
Pitch: 38 x 38 mm*

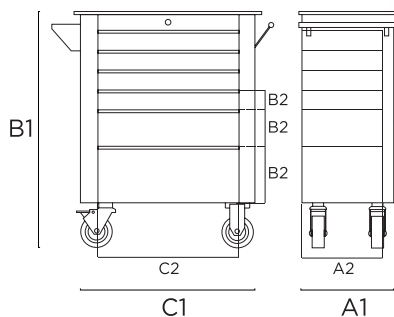

Codice	C2 x B2 x A2 mm	Portata statica / Static flow rate (Kg)	Portata cassetto / Drawer capacity (Kg)	C1 x B1 x A1 mm	kg	Barcode
886001	Carrello base / Basic trolley	800		770 x 925 x 476	70	80331835717000
	5 Cassetti piccoli / Small drawers	570 x 50 x 415	35			
	1 Cassetto medio / Medium drawer	570 x 93 x 415	35			
	1 Cassetto grande / Big drawer	570 x 155 x 415	35			
888001T	Tappetino per cassetti / Drawer mat				1	8033183590053
88801DF	Divisori in ferro / Iron dividers				2	8033183590060
881801PB	Porta barattoli / Jar holder				3	8033183590077
881801PC	Porta carta / Paper holder				1	8033183590046

886501 CARRELLO PORTAUTENSILI TOOL HOLDER TROLLEY



- 6 cassetti ad angoli arrotondati (4 piccoli, 1 medio, 1 grande) richiudibili su cuscinetti a sfere e piano in ABS gofrato
6 drawers with rounded corners (4 small, 1 medium, 1 large) reclosable on ball bearings and embossed ABS top
- Dotato di serratura che impedisce l'apertura indesiderata durante il trasporto e l'accesso non autorizzato
Equipped with a lock that prevents unwanted opening during transport and unauthorized access
- Munito di inserti filettati, per un montaggio facile e veloce
Equipped with threaded inserts, for quick and easy assembly
- Maniglia reversibile destra / sinistra
Right / left reversible handle
- Disponibili su richiesta una vasta gamma di accessori
A wide range of accessories available on request



- 1** 886501T Tappeto di gomma espansa per cassetti
Expanded rubber mat for drawers



- 2** 886501 2 divisori per cassetto (in plastica o ferro)
2 drawer dividers (plastic or iron)



- 3** 886501PB Porta barattoli
Jar holder



- 4** 886501PC Porta carta
Paper holder

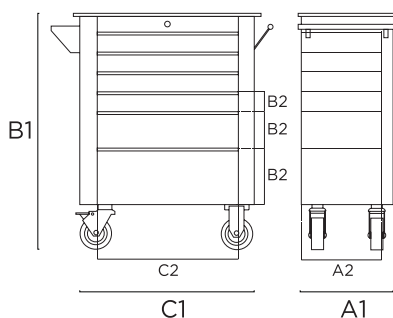

Codice	C2 x B2 x A2 mm	Portata statica / Static flow rate (Kg)	Portata cassetto / Drawer capacity (Kg)	C1 x B1 x A1 mm	kg	Icona	Barcode
886501	Carrello base / <i>Basic trolley</i>		800	710 x 840 x 476	63	1	8033183568052
	4 Cassetti piccoli / <i>Small drawers</i>	610 x 50 x 400					
	1 Cassetto medio / <i>Medium drawer</i>	610 x 93 x 400					
	1 Cassetto grande / <i>Big drawer</i>	610 x 155 x 400					
886501T	Tappetino per cassetti / <i>Drawer mat</i>					1	8033183590084
886501DF	Divisori in ferro / <i>Iron dividers</i>					2	8033183571809
886501DP	Divisori in plastica / <i>Plastic dividers</i>					2	8033183571816
886501PB	Porta barattoli / <i>Jar holder</i>					3	8033183571823
886501PC	Porta carta / <i>Paper holder</i>					1	8033183571830



886101 CARRELLO PORTAUTENSILI TOOL HOLDER TROLLEY

- 6 cassetti ad angoli arrotondati (2 piccoli, 3 medio, 1 grande) richiudibili su cuscinetti a sfere e piano in ABS goffrato e utilizzabili in **9 combinazioni differenti**
6 drawers with rounded corners (2 small, 3 medium, 1 large) reclosable on ball bearings and top in embossed ABS and usable in 9 different combinations
- Dotato di serratura che impedisce l'apertura indesiderata durante il trasporto e l'accesso non autorizzato
Equipped with a lock that prevents unwanted opening during transport and unauthorized access
- Munito di inserti filettati, per un montaggio facile e veloce
Equipped with threaded inserts, for quick and easy assembly
- Maniglia reversibile destra / sinistra
Right / left reversible handle
- Disponibili su richiesta una vasta gamma di accessori
A wide range of accessories available on request



ALTRE COMBINAZIONE CASSETTI DRAWERS COMBINATION

	Cassetti piccoli / Small drawers	Cassetti medi / Medium drawers	Cassetti grandi / Big drawers
886101B	9	-	-
886101C	6	2	-
886101D	5	1	1
886101E	3	4	-
886101F	4	2	-
886101G	-	6	-
886101H	1	2	2
886101I	-	1	3

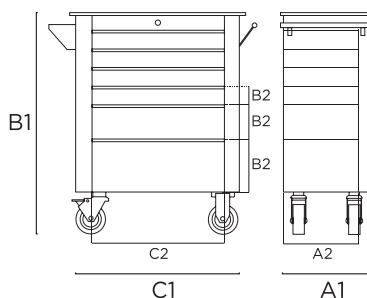

- 1** **886501T** Tappeto di gomma espansa per cassetti
Expanded rubber mat for drawers



- 2** **886501** 2 divisori per cassetto (in plastica o ferro)
2 drawer dividers (plastic or iron)



- 3** **886501PB** Porta barattoli
Jar holder



- 4** **886501PC** Porta carta
Paper holder



Codice		C2 x B2 x A2 mm	Portata statica / Static flow rate (Kg)	Portata cassetto / Drawer capacity (Kg)	C1 x B1 x A1 mm	kg		Barcode
886101	Carrello base / Basic trolley		800		710 x 925 x 476	57	1	8033183571748
	2 Cassetti piccoli / Small drawers	610 x 50 x 400		40				
	3 Cassetti medi / Medium drawers	610 x 93 x 400		40				
	1 Cassetto grande / Big drawer	610 x 155 x 400		40				
886101T	Tappetino per cassetti / Drawer mat						1	8033183590091
886101DF	Divisori in ferro / Iron dividers						2	8033183571755
886101DP	Divisori in plastica / Plastic dividers						2	8033183571762
886101PB	Porta barattoli / Jar holder						3	8033183571779
886101PC	Porta carta / Paper holder						1	8033183571786

880801 BANCO DA LAVORO WORK STATION

- In lamiera verniciata con spessore da 2,5 mm e bordi anticaduta
In painted sheet with a thickness of 2.5 mm and anti-fall edges
- Piano inferiore d'appoggio e 2 cassetti che scorrono su cuscinetti a sfere con estrazione totale, dotati di sistema di chiusura con chiave
Lower support surface and 2 drawers that slide on bearings ball-bearing with total extraction, equipped with a locking system with key
- Disponibile nei colori rosso e grigio
Available in red and grey colours



Codice		Portata statica / Static flow rate (Kg)	mm	kg		Barcode
880801	● ●	1500	880 x 1500 x 650	65	1	8033183571656
880901	● ●	1500	880 x 2000 x 650	74	1	8033183571663

910102 PANNELLO PORTATTREZZI PER BANCO DA LAVORO TOOL HOLDER PANEL FOR WORK BENCH

- In lamiera forata verniciata con poggia utensili
In painted perforated sheet metal with tool rest
- Disponibili su richiesta ganci per pannello
Panel hooks available on request
- Disponibile nei colori rosso e grigio
Available in red and grey colours



Codice		Foro / Hole Ø mm	mm	kg		Barcode
910102	●	5	830 x 1000	6	1	8033183590138
910103	● ●	5	830 x 1500	9	1	8033183590145
910104	● ●	5	830 x 2000	12	1	803318350152

880601P SCAFFALE PORTA BULLONI BOLT HOLDER SHELF

- In plastica resistente
Made of durable plastic
- Composto da comode cassette porta bulloni per disporre tutti gli articoli in modo ordinato e preciso
Consisting of convenient bolt boxes to arrange everyone the items in an orderly and precise manner



Codice		N. cassette / N. boxes	mm	kg		Barcode
880601P	●	30	580 x 685 x 135	11	1	8033183571656
880601G	●	60	1000 x 685 x 135	23	1	8033183571663

876002 BAULE PORTAUTENSILI TOOL HOLDER PANEL FOR WORK BENCH

- Prodotto in lamiera d'acciaio verniciata rossa, leggera e resistente agli agenti atmosferici
Made of red painted sheet steel, light and resistant to atmospheric agents
- 2 impugnature ergonomiche laterali e chiusura lucchettabile per la massima sicurezza
2 ergonomic side handles and padlockable closure for maximum safety



Codice		mm	kg		Barcode
876002	●	405 x 805 x 490	13	1	8033183571571

Soluzioni espositive

Display solutions

Forniti in comodato d'uso gratuito con un minimo d'ordine stabilito, per l'esposizione dei nostri prodotti.
 Provided on free loan with a minimum order established, for the display of our products.

700000 VETRINA DA BANCO COUNTER SHOWCASE

- ♦ Struttura interamente in vetro temperato con porta basculante, dotata di serratura di sicurezza e 2 ripiani in stile moderno per l'esposizione

Structure entirely in tempered glass with overhead door, equipped with safety lock and 2 modern style shelves for the exhibition

- ♦ Fornita con ganci per l'esposizione

Supplied with display hooks

- ♦ Fornita in comodato d'uso con ordine minimo di 850,00€ netti

Provided on loan for use with a minimum order of € 850.00 net



Codice	mm		Barcode
700000	400 x 250 x 600	1	8033183571175

700003 ARMADIO VETRINA SHOWCASE CABINET

- ♦ Struttura interamente in vetro temperato a 2 ante, dotato di serratura di sicurezza, fondo forato per l'esposizione tramite ganci e 4 rotelle girevoli

Structure entirely in tempered glass with 2 doors, equipped with safety lock, perforated bottom for display using hooks and 4 swivel castors

- ♦ Fornito con ganci per l'esposizione

Supplied with display hooks

- ♦ Fornito in comodato d'uso con ordine minimo di 1800,00€ netti

Provided on loan for use with a minimum order of € 1800.00 net



Codice	mm		Barcode
700003	1800 x 800 x 400	1	8033183550842

700002 ESPOSITORE DA TERRA MONOFACCIALE SINGLE-SIDED FLOOR DISPLAY

- ♦ Espositore in rete metallica costituito da uno spazio superiore predisposto per l'inserimento di un crowner (650 x 190 mm) e base in lamiera verniciata con piedini antiscivolo

Exhibitor in wire mesh consisting of an upper space prepared for the insertion of a crowner (650 x 190 mm) and base in painted sheet metal with non-slip feet

- ♦ Fornito con ganci per l'esposizione e crowner grafico Fumasi

Supplied with display hooks and Fumasi graphic crowner

- ♦ Fornito in comodato d'uso con ordine minimo di 850,00€ netti

Provided on loan for use with a minimum order of € 850.00 net



Codice	mm		Barcode
700002	650 x 2000	1	8033183550811

910101 PANNELLO PORTATTREZZI FORATO
PERFORATED TOOL PANEL

- In lamiera forata verniciata
In painted perforated sheet metal
- Fornito con ganci per l'esposizione
Supplied with display hooks
- Fornito in comodato d'uso con ordine minimo di 500,00€ netti
Provided on loan for use with a minimum order of € 500.00 net

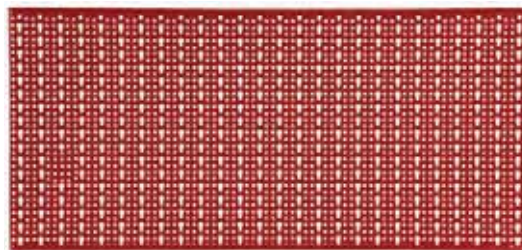

Codice		mm	kg		Barcode
910101	●	1180 x 940	9	1	8033183550835
910105	●	2000 x 940	16	1	8033183571069

EFFICIENZA IN OGNI STAGIONE

EFFICIENCY IN EVERY SEASON

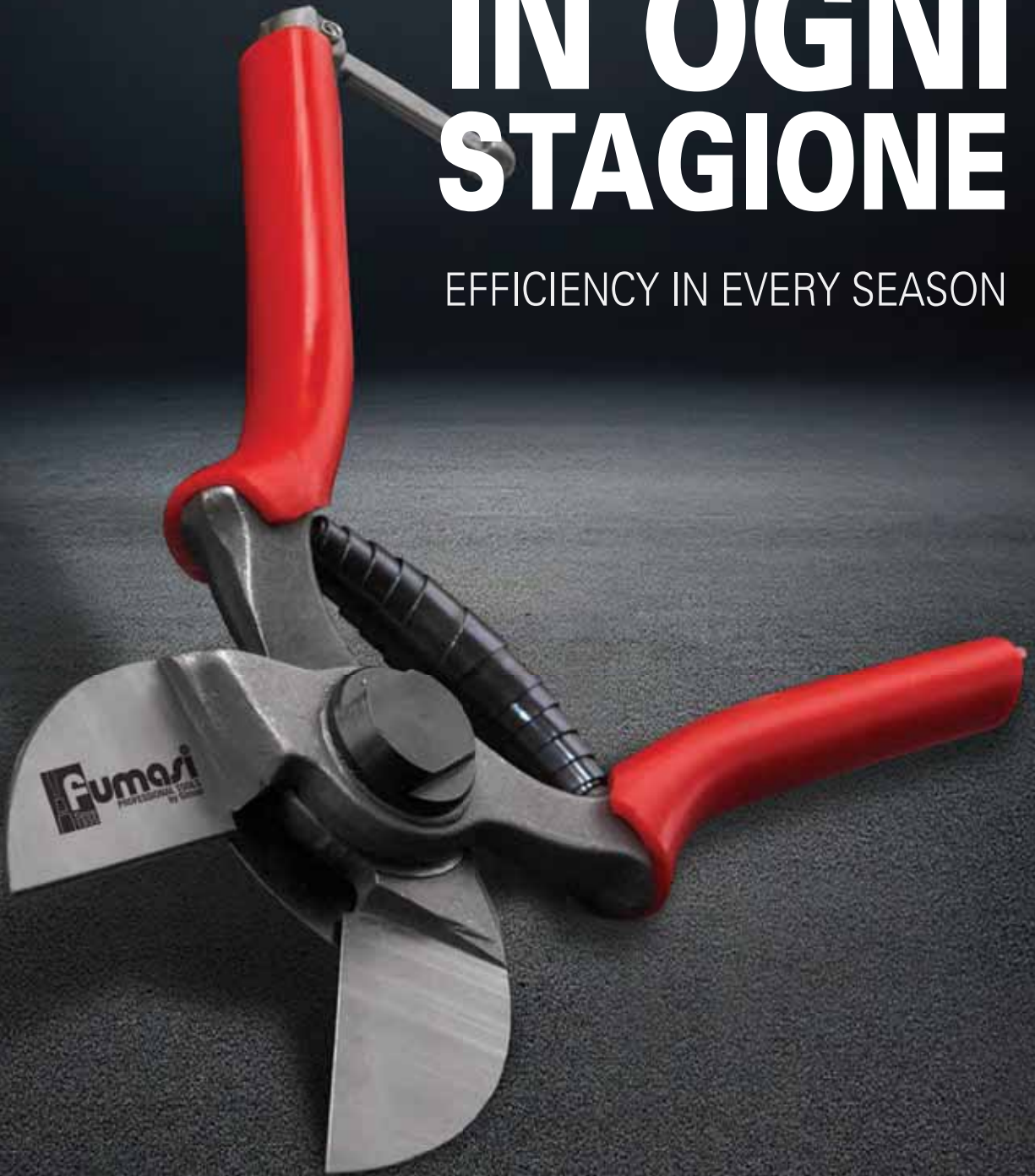

LINEA PRO
PRO LINE



DISPONIBILE LAMA DI RICAMBIO
SPARE BLADE AVAILABLE

- 308** Cesoie da potatura professionali
Professional pruning shears
- 312** Cesoie da potatura SK-5
SK-5 pruning shears
- 313** Cesoie da potatura standard
Standard pruning shears
- 316** Cesoie multiuso
Multi-purpose scissors

COME SCEGLIERE UNA FORBICE DA POTATURA

HOW TO CHOOSE A PRUNING SHEAR

Le forbici da potatura si suddividono sostanzialmente in 3 categorie sulla base del sistema di taglio:

Pruning shears are basically divided into 3 categories based on the cutting system:

- 1 BATTENTE (A INCUDINE):** Questo tipo di forbice da potatura è composto da una singola lama la quale effettua un taglio che termina su una specie di incudine, il battente. I modelli a lama battente trattengono meglio il ramo e facilitano le operazioni di taglio. **Adatto alla potatura di legni duri o secchi; nei rami giovani e più freschi, il battente potrebbe segnare e schiacciare un po' il ramo.**
*SWING (ANVUS): This type of pruning shears is composed of a single blade which it performs a cut that ends on a kind of anvil, the sash.
The blade and swing models hold the branch better and facilitate cutting operations.
Suitable for pruning hard or dry woods, in young and fresher branches, the leaf could mark and squeeze the branch a little.*
- 2 PASSANTE (BY PASS):** Questo tipo di forbice è composta da una lama che durante il movimento di taglio sfiora ed oltrepassa la contro lama, creando così un taglio preciso ed esente da sbavature. **Adatto alla potatura in zone dense di rami in legno verde e fresco; nei rami vecchi e più duri le lame potrebbero tendere a divaricarsi e non eseguire un perfetto taglio.**
*This type of scissor consists of a blade that during movement of cutting touches and goes beyond the counterblade, thus creating a precise and smudge-free cut.
Suitable for pruning in dense areas of green and fresh wood branches; in the old and hardest branches the blades may tend to spread apart and not make a perfect cut.*
- 3 A DOPPIA TAGLIO:** Questo tipo di forbice è composto da due lame che durante il movimento di taglio si incontrano nel mezzo. **Grazie a questo tipo di meccanismo il ramo viene compresso molto meno e si cicatrizza più velocemente, motivo per cui sono adatte in frutticoltura e nel taglio delle rose.**
*DOUBLE CUT: This type of scissors is composed of two blades that during the cutting movement meet in the middle.
Thanks to this type of mechanism, the branch is compressed much less and heals more quickly, which is why they are suitable for fruit growing and for cutting roses.*

Ci sono forbici che adottano un particolare sistema di taglio definito **“a cricchetto”** e sono indicate **per il taglio di rami particolarmente duri.**

Il sistema a cricchetto permette di distribuire lo sforzo di taglio.

*There are scissors that adopt a particular cutting system called "ratchet" and are suitable for cutting branches particularly hard
The ratchet system allows to distribute the cutting effort.*

SCEGLIERE SECONDO I MATERIALI

CHOOSE ACCORDING TO THE MATERIALS

Il tipo di materiale che costituisce la lama incide direttamente sulle caratteristiche di resistenza all'usura e sulla capacità della forbice di rimanere affilata per molto tempo:

- Le lame in acciaio (anche trattato al carbonio) garantiscono un'elevata qualità e la massima resistenza alla ruggine.

Le migliori lavorazioni comprendono la forgiatura a caldo, la cromatura e vari tipo di tempre.

- Le lame in alluminio garantiscono un taglio leggero e resistente.

The type of material that makes up the blade directly affects the wear resistance characteristics and the capacity of the scissors to stay sharp for a long time:

- *The steel blades (also treated with carbon) guarantee high quality and maximum resistance to rust.*

The best processes include hot forging, chrome plating and various types of hardening.

- *The aluminum blades ensure a light and resistant cut.*

Cesoie da potatura

Pruning shears

► Linea PRO

PRO line

Estremamente resistenti grazie ai materiali che le costituiscono, come l'acciaio delle lame, arricchito con alte dosi di carbonio, forgiato a caldo e con durezza 56 -58 HRC, per effettuare tagli di grosse dimensioni e il rivestimento delle impugnature che ne garantisce un uso di massimo comfort.

Extremely resistant thanks to the materials that constitute them, such as the steel of the blades, enriched with high doses of carbon, hot forged and with a hardness of 56 -58 HRC, to make large cuts and the coating of the handles that guarantees the use of maximum comfort.

Cesoie da potatura forgiate

Forged pruning shears

230827 CESCOIE PROFESSIONALI A DOPPIO TAGLIO

PROFESSIONAL DOUBLE-CUT SHEARS

- ♦ **Realizzate completamente in acciaio C60 arricchito al carbonio di prima qualità, forgiato a caldo, temprato con speciali metodi HRC**
Made entirely of C60 steel enriched with top quality carbon, hot forged, hardened with special HRC methods
- ♦ **Lame a doppio taglio che permette di evitare lo schiacciamento della corteccia e del ramo, con piastra posteriore per arresto di ramoscelli**
Double-edged blades that prevent the crushing of the bark and branch, with back plate for stopping twigs
- ♦ **Manici ergonomici in acciaio, plastificati in materiale atossico e con chiusura di sicurezza**
Ergonomic handles in hot forged aluminum coated in material non-slip with safety lock
- ♦ **Perno ad alta trasmissione con sistema di apertura e chiusura molto soffice**
High transmission pin with very open and close system fluffy

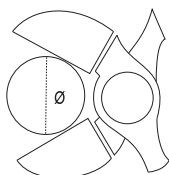

Codice	ø mm	mm		Barcode
230827	30	190	6	8033183551580
230828	30	210	6	8033183553003
230829	30	200	6	8033183581181



230877 CESCOIE PROFESSIONALI A DOPPIO TAGLIO DOUBLE-CUT PROFESSIONAL SHEARS



- ♦ **Lame forgiata a caldo** a doppio taglio che permette di evitare lo schiacciamento della corteccia e del ramo, con piastra posteriore per arresto di ramoscelli
Double-edged hot-forged blades that allows you to avoid it crushing of the bark and branch, with back plate for stop of twigs
- ♦ Manici ergonomici in alluminio, rivestiti in materiale antiscivolo e con sistema di chiusura **Easy Block System**
Ergonomic aluminum handles covered in non-slip material with with Easy Block System closing system

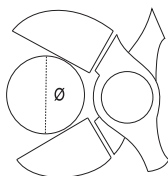

Codice		Ø mm	mm		Barcode
230877		28	210	6	8033183574787
231877	Lama ricambio / Spare blade			1	8033183574886

230876 CESCOIE PROFESSIONALI BY PASS PROFESSIONAL BY PASS SHEARS



- ♦ **Lame forgiata a caldo** a doppio taglio che permette di evitare lo schiacciamento della corteccia e del ramo
Double-edged hot-forged blades that allows you to avoid it crushing of the bark and branch
- ♦ Manici ergonomici in alluminio, rivestiti in materiale antiscivolo, gommini paracolpi per un miglior assorbimento del taglio e con sistema di chiusura **Easy Block System**
Ergonomic aluminum handles covered in non-slip material with rubber bumpers for better absorption of the cut and with system Easy Block System closure

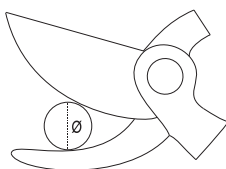

Codice		Ø mm	mm		Barcode
230876		26	210	6	8033183574770
231876	Lama ricambio / Spare blade			1	8033183574879

230878 CESCOIE PROFESSIONALI BY PASS PROFESSIONAL BY PASS SHEARS



- ♦ **Lame forgiata a caldo** curve e battenti in alluminio per legno duro
Hot forged curved and striking aluminum blades for hard wood
- ♦ Manici ergonomici in alluminio rivestiti in materiale antiscivolo con sistema di chiusura **Easy Block System**
Ergonomic aluminum handles covered in non-slip material with Easy Block System closing system

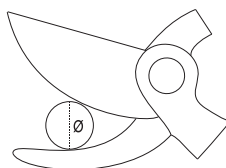

Codice		Ø mm	mm		Barcode
230878		26	210	6	8033183574794
231878	Lama ricambio / Spare blade			1	8033183574831

230879 CESOIE PROFESSIONALI A INCUDINE PROFESSIONAL ANVEL SHEARS

- ♦ **Lame rette e battenti in alluminio forgiata a caldo** per legno duro
Hot forged straight and striking aluminum blades for hard wood
- ♦ **Manici ergonomici in alluminio rivestiti in materiale antiscivolo, con sistema di chiusura Easy Block System**
Ergonomic aluminum handles covered in non-slip material with Easy Block System closing system

Codice		mm		Barcode
230879		210	6	8033183574800
231879	Lama ricambio / Spare blade		1	8033183574848



230865 CESOIE PROFESSIONALI PER VIGNA BY PASS PROFESSIONAL SHEARS FOR VINEYARD BY PASS

- ♦ **Realizzate completamente in acciaio forgiato a caldo** garanzia di ottima qualità di taglio e durata
Made entirely of hot forged steel excellent cutting quality and durability
- ♦ **Manici ergonomici in acciaio rivestiti in materiale antiscivolo**
Ergonomic aluminum handles covered in non-slip material

Codice		mm		Barcode
230865		210	6	8033183574732



230880 CESOIE PROFESSIONALI A DOPPIO TAGLIO DOUBLE-CUT PROFESSIONAL SHEARS

- ♦ **Realizzate completamente in acciaio forgiato a caldo** garanzia di ottima qualità di taglio e durata
Made entirely of hot forged steel excellent cutting quality and durability
- ♦ **Lame a doppio taglio che permette di evitare lo schiacciamento della corteccia e del ramo**
Double-edged blades that prevent the crushing of the bark and branch
- ♦ **Manici ergonomici in acciaio rivestiti in materiale antiscivolo**
Ergonomic aluminum handles covered in non-slip material
- ♦ **Cinturino di fermo**
Stop strap

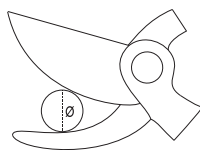

Codice		ø mm	mm		Barcode
230880		23	210	6	8033183574817



223718 CESOIE PROFESSIONALI PER VIGNA BY PASS PROFESSIONAL SHEARS FOR VINEYARD BY PASS

- ♦ **Realizzate completamente in acciaio forgiato a caldo** garanzia di ottima qualità di taglio e durata
Made entirely of hot forged steel excellent cutting quality and durability
- ♦ **Manici ergonomici in acciaio rivestiti in materiale antiscivolo**
Ergonomic aluminum handles covered in non-slip material
- ♦ **Cinturino di fermo**
Stop strap

Codice		mm	gr		Barcode
223718		180	238	6	8033116545075
223721		210	250	6	8033116545082
223723		230	270	6	8033116545099



230862 CESCOIE PROFESSIONALI BY PASS
PROFESSIONAL BY PASS SHEARS

- ♦ **Lame in acciaio forgiate a caldo** a finitura lucida
Hot-forged steel blades with a polished finish
- ♦ **Manici ergonomici in alluminio rivestiti in materiale antiscivolo**
Ergonomic aluminum handles covered in non-slip material

Codice		mm		Barcode
230862		210	6	8033183574824
231862	Lama ricambio / Spare blade		1	8033183574855



223322 CESCOIE PROFESSIONALI PER VIGNA BY PASS
PROFESSIONAL SHEARS FOR VINEYARD BY PASS

- ♦ **Lame in acciaio forgiate a caldo** a finitura lucida
Hot-forged steel blades with a polished finish
- ♦ **Manici con cuore in acciaio e doppio rivestimento in nylon, rivestiti in materiale antiscivolo**
Handles with steel heart and double nylon coating e covered in non-slip material
- ♦ **Vite centrale temprata, irremovibile grazie al portalama filettato internamente ed al dado di sicurezza**
Hardened central screw irremovable thanks to the threaded blade holder internally and to the safety nut

Codice		mm		Barcode
223322		220	6	8033183574824
223323	Lama ricambio / Spare blade		1	8033183574855



223850 CESCOIE RACCOGLI UVA E FRUTTA
SHEARS COLLECT GRAPES AND FRUITS

- ♦ **Lame in acciaio nichelato di alta qualità con punte molto sottili** che permettono tagli precisi anche nei punti più difficili
High quality nickel-plated steel blades with very fine points that allow precise cuts even in the most difficult points
- ♦ **Manici ergonomici ad anelli rivestiti in materiale antiscivolo**
Ergonomic ring handles covered in non-slip material

Codice		mm		Barcode
223850		140	6	8033183575012



227831 CESCOIE RACCOGLI UVA E FRUTTA
SHEARS COLLECT GRAPES AND FRUITS

- ♦ **Lame dritte in acciaio nichelato di alta qualità con punte molto sottili** che permettono tagli precisi anche nei punti più difficili
Straight blades made of high quality nickel-plated steel with very fine points that allow precise cuts even in the most difficult points
- ♦ **Manici ergonomici chiusi rivestiti in materiale antiscivolo**
Ergonomic closed handles covered in non-slip material

Codice		mm		Barcode
227831		200	6	8033116545068



Cesoie da potatura SK-5

SK-5 pruning shears

230851R CESCOIE IN ALLUMINIO METAL COLOR METAL COLOR ALUMINUM SHEARS

- Realizzate in alluminio 6061 trattato con colori speciali
Made of 6061 aluminum treated with special colors
- **Lame in acciaio al carbonio SK-5** con durezza di 56 HRC
SK-5 carbon steel blades with a hardness of 56 HRC
- Manici in alluminio forgiato con presa Soft Touch rivestiti al titanio
Forged aluminum handles titanium coated

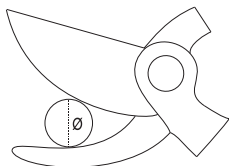

Codice		∅ mm	mm		Barcode
230851R		20	220	6	8033183598844
230851B		20	220	6	8033183598851



230857 CESCOIE IN ALLUMINIO EFFETTO LEGNO WOOD EFFECT ALUMINUM SHEARS

- Realizzate in alluminio 6061 con finitura in finto legno
Made of 6061 aluminum
- **Lame in acciaio al carbonio SK-5** con durezza di 56 HRC
SK-5 carbon steel blades with a hardness of 56 HRC
- Manici in alluminio forgiato con presa Soft Touch rivestiti al titanio
Forged aluminum handles titanium coated
- Blocco di sicurezza a spinta
Push safety lock

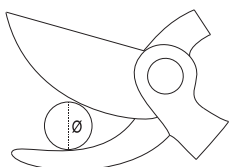

Codice		∅ mm	mm		Barcode
230857		20	215	6	8033183598783



230864 CESCOIE PROFESSIONALI GIARDINAGGIO PROFESSIONAL GARDENING SHEARS

- **Lame in acciaio al carbonio SK-5** con durezza di 52-54 HRC
SK-5 carbon steel blades with a hardness of 52-54 HRC
- Manici in alluminio forgiato
Forged aluminum handles
- Blocco di sicurezza a spinta
Push safety lock

Codice		mm		Barcode
230864		215	6	8033183575920



► Linea standard

Standard line

Gli utenti occasionali potranno scegliere tra una vasta gamma di forbici per giardinaggio della linea economica, costituite da acciaio al carbonio, che ne garantisce l'efficacia e la qualità, offrendo prestazioni di ottimo livello.

Occasional users will be able to choose from a wide range of economic line gardening shears, made of carbon steel, which guarantees their effectiveness and quality, offering excellent performance.

223900 CESCOIE DA POTATURA BY PASS VINEYARD BY PASS SHEARS

- Lame in acciaio al carbonio e manici ergonomici in alluminio rivestiti in materiale antiscivolo
Carbon steel blades and ergonomic handles in coated aluminum in no-slip material
- Sistema di bloccaggio ammortizzato
Amortized locking system

Codice	mm		Barcode
223900	210	12	8033116545143



230866 CESCOIE DA POTATURA BY PASS VINEYARD BY PASS SHEARS

- Lame in acciaio al carbonio con rivestimento antiaderente e antiruggine in Teflon e manici ergonomici in polipropilene leggeri e maneggevoli con impugnatura morbida antiscivolo
Carbon steel blades with non-stick coating and rustproof Teflon and ergonomic handles in lightweight polypropylene and handy with soft non-slip handle
- Doppia apertura S/L per adeguare l'ampiezza del taglio alla dimensione della mano
Double opening S/L to adapt the opening of the cut to the hand size
- Pratico sistema di chiusura
Practical locking system

Codice	mm		Barcode
230866	200	6	8033183583321



230858 CESCOIE DA POTATURA IN ALLUMINIO BY PASS BY PASS ALUMINUM PRUNING SHEARS

- Lame forgiate di alta qualità, affilate su entrambi i lati per un taglio pulito e senza sforzo e manici in alluminio satinato
High quality forged blades sharpened on both sides for a cut clean and effortless Forged aluminum handles
- Blocco di sicurezza a spinta
Push safety lock

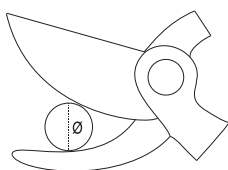

Codice	ø mm	mm		Barcode
230858	10	210	6	8033183591302



230859 CESOIE DA POTATURA BY PASS
BY PASS PRUNING SHEARS

- Lame in acciaio al carbonio e manici ergonomici in composito per una presa confortevole
Carbon steel blades and ergonomic composite handles for a comfortable opening
- Blocco di sicurezza a spinta
Push safety lock

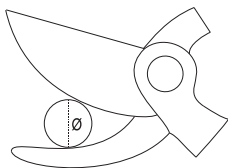

Codice	ø mm	mm		Barcode
230859	16	210	6	8033183591319

230863 CESOIE PROFESSIONALI BY-PASS
PROFESSIONAL BY-PASS SHEARS

- Lame in acciaio al carbonio con rivestimento antiaderente e antiruggine in Teflon
Carbon steel blades with non-stick coating and anti-rust in Teflon
- Manici ergonomici in alluminio rivestiti in materiale antiscivolo
Ergonomic aluminum handles covered in non-slip material



Codice	mm		Barcode
230863	200	6	8033183586599

230860 CESOIE DA POTATURA BY PASS
BY PASS PRUNING SHEARS

- Lame in acciaio Teflonato e manici ergonomici in termoplastica con impugnatura morbida antiscivolo
Teflon-coated steel blades and ergonomic thermoplastic handles with soft non-slip grip
- Doppia apertura S/L per adeguare l'ampiezza del taglio alla dimensione della mano
Double opening S/L to adapt the opening of the cut to the hand size
- Blocco di sicurezza a spinta
Push safety lock

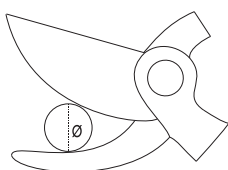

Codice	ø mm	mm		Barcode
230860	12	205	6	8033183575876

230861 CESOIE PER POTATURA PROFESSIONALI BY-PASS
BY-PASS PROFESSIONAL PRUNING SHEARS

- Lame in acciaio al carbonio con rivestimento antiaderente e antiruggine in Teflon
Carbon steel blades with non-stick coating and anti-rust in Teflon
- Manici ergonomici in polipropilene e fibra di vetro
Ergonomic handles in polypropylene and glass fiber
- Sistema di bloccaggio a gancio
Hook locking system



Codice	mm		Barcode
230861	195	6	8033183575883

223918 CESCOIE A CRICCHETTO
RATCHET SHEARS

- Lame in acciaio al carbonio con rivestimento antiaderente e antiruggine in Teflon
Carbon steel blades with non-stick coating e anti-rust in Teflon
- Manici in alluminio gommati con rivestimento antiscivolo e protezione anteriore della mano
Rubberized aluminum handles with anti-slip coating and protection front of the hand
- Con l'impiego del cricchetto è possibile tagliare con estrema facilità i rami più resistenti; a seconda del diametro si consiglia di sfruttare il cricchetto a più riprese, ripetendo la pressione fino a completare il taglio
With the use of the ratchet it is possible to cut the branches very easily more resistant; depending on the diameter, it is recommended to use the ratchet several times, repeating the pressure until the cut is complete



Codice	mm		Barcode
223918	200	6	8033116545174

220868 CESCOIE PER POTATURA BY PASS ECO
BY PASS ECO PRUNING SHEARS

- Lame in acciaio al carbonio con rivestimento antiaderente e antiruggine in Teflon
Carbon steel blades with non-stick coating e anti-rust in Teflon
- Manici ergonomici in polipropilene
Ergonomic handles in polypropylene
- Sistema di bloccaggio a spinta
Push safety lock



Codice	mm		Barcode
230868	200	6	8033183575906

220869 CESCOIE PER POTATURA BY PASS ECO
BY PASS ECO PRUNING SHEARS

- Lame in acciaio al carbonio con rivestimento antiaderente e antiruggine in Teflon
Carbon steel blades with non-stick coating e anti-rust in Teflon
- Manici ergonomici in alluminio rivestiti in PVC
Ergonomic handles in polypropylene
- Sistema di bloccaggio a spinta
Push safety lock



Codice	mm		Barcode
230869	220	6	8033183575913

223521 CESCOIE PER POTATURA BY PASS
BY PASS PRUNING SHEARS

- Lame in acciaio INOX e manici ergonomici in materiale plastico
Carbon steel blades with non-stick coating e anti-rust in Teflon
- Tipo leggero
Light type



Codice	mm		Barcode
223521	210	6	8033116545105

223525 CESCOIE PER POTATURA BY PASS
BY PASS PRUNING SHEARS

- Lama e molla di ritorno in acciaio INOX
Stainless steel blades and return spring
- Manici ergonomici in alluminio rivestiti in materiale plastico con la presa in morbida spugna antisudore
Ergonomic handles in aluminum coated in plastic material with the grip in soft anti-sweat sponge

Codice	mm		Barcode
223525	210	6	8033183563323

**Cesoie multiuso**
Multi-purpose shears**230832** CESCOIE MULTIUSO INOX BY PASS
MULTIPURPOSE STAINLESS STEEL BY PASS SHEARS

- Lama in acciaio INOX temperato con filatura molto accurata e manici rivestiti in polipropilene dal design ergonomico
Tempered stainless steel blade with very accurate spinning and handles covered in polypropylene with an ergonomic design
- Sistema di bloccaggio a spinta
Push locking system

Codice	mm		Barcode
230832	190	6	8033116539654

**230823** CESCOIE MULTIUSO INOX
MULTIPURPOSE STAINLESS STEEL SHEARS

- Lama microdentata in acciaio INOX, affilata, resistente all'usura con tacca tagliacavo per fili sottili con comoda impugnatura ergonomica in bimatetiale
Micro-toothed stainless steel blade, sharp, wear resistant with notch cable cutter for fine wires with comfortable grip ergonomic in bi-material
- Con molla che riduce l'affaticamento della mano e fermo di chiusura
With spring that reduces hand fatigue and locking latch

Codice	mm		Barcode
230823	190	6	8033183559418

**230822** CESCOIE MULTIUSO INOX DOPPIA APERTURA
DOUBLE OPENING STAINLESS STEEL MULTIPURPOSE SHEARS

- Lama microdentata in acciaio INOX con durezza di 60 HRC e comoda impugnatura ergonomica in bimatetiale
Micro-toothed stainless steel blade with a hardness of 60 HRC and comfortable ergonomic bi-material handle
- Doppia apertura S/L per adeguare l'ampiezza del taglio alla dimensione della mano
Double opening S/L to adapt the opening of the cut to the hand size
- Sistema di bloccaggio a spinta
Push locking system

Brevetto di utilità Fumasi: **PAT. 0000265248**
Fumasi utility patent: PAT. 0000265248

Codice	mm		Barcode
230822	190	12	8033183551368



230821B CESCOIE MULTIUSO INOX
DOUBLE OPENING MULTIPURPOSE SHEARS



- Lama microdentata in acciaio INOX con durezza di 60 HRC e comoda impugnatura ergonomica in bimatereale
Micro-toothed stainless steel blade with a hardness of 60 HRC and comfortable ergonomic bi-material handle
- Sistema di bloccaggio a spinta
Push locking system



Codice	mm		Barcode
230821B	190	6	8033183551566

230831B CESCOIE MULTIUSO INOX
DOUBLE OPENING MULTIPURPOSE SHEARS



- Lama microdentata in acciaio INOX con durezza di 60 HRC e comoda impugnatura ergonomica in bimatereale
Micro-toothed stainless steel blade with a hardness of 60 HRC and comfortable ergonomic bi-material handle
- Speciale angolatura di taglio per facilitare l'esecuzione di tagli lunghi
Special cutting angle to facilitate the execution of long cuts
- Sistema di bloccaggio a spinta
Push locking system

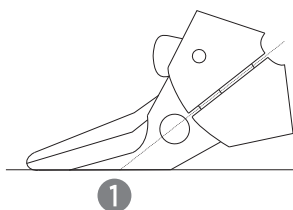

Codice	mm		Barcode
230831B	185	6	8033183551573

223945 ESPOSITORE CESCOIE PER POTATURA
EXHIBITOR OF SHEARS FOR PRUNING

Codice	Pezzi / pieces			Barcode
223945	12	4 x 223910 - 223521 - 223525	1	8033183568939



223946 ESPOSITORE CESCOIE PER POTATURA
EXHIBITOR OF SHEARS FOR PRUNING

Codice	Pezzi / pieces			Barcode
223946	12	4 x 230828 - 223521 - 223718	1	8033183568946



233250 CESOIE MULTIUSO SMONTABILE REMOVABLE MULTIPURPOSE SHEARS

- ♦ **Lame in acciaio INOX con tacca apribottiglie**
Stainless steel blades with bottle opener notch
- ♦ **Manico in polipropilene e fibra di vetro ad anelli asimmetrici per meglio guidare il taglio e rendono agevole il lavoro anche agli operatori mancini**
Polypropylene and fiberglass handle with asymmetrical rings for better guide the cut and make work easier even for left-handed operators
- ♦ **Lame smontabili per una facile pulizia**
Removable blades for easy cleaning

Codice	mm	gr		Barcode
233250	200	110	6	8033183551597



233255TGN CESOIE MULTIUSO IN TITANIO MULTIPURPOSE SHEARS TITANIUM COATED

- ♦ **Lame microdentate in acciaio INOX temperato con rivestimento al titanio che conferisce un taglio scorrevole e durevole nel tempo**
Micro-toothed blades are in hardened stainless steel with coating titanium which gives a smooth and long-lasting cut
- ♦ **Lame antiruggine e lavabili in lavastoviglie**
Rustproof and dishwasher safe blades
- ♦ **Manici in bimatereale dalla forma ergonomica un rivestimento interno in materiale morbido per un'impugnatura confortevole**
Ergonomically shaped bi-material handles with a coating interior in soft material for a comfortable grip
- ♦ **Manico ad anelli asimmetrici (nelle misure grandi) per meglio guidare il taglio, rendendo agevole il lavoro anche agli operatori mancini**
Handle with asymmetrical rings (in large sizes) for better driving cutting and make work easier even for left-handed operators

Codice	Pezzi / Pieces	mm		Barcode
233255TGN		135	12	8033183583604
233265TGN		165	12	8033183583611
233480TGN		210	12	8033183583598
233490TGN		230	12	8033183584236
234380TGN	24	Espositore / Exhibitor 6 x 233255TGN - 65TGN; 6 x 233480TGN - 90TGN		8033183836229



STRUMENTI MANEGGEVOLI PER BUONE PRESTAZIONI

HANDY TOOLS FOR GOOD PERFORMANCE



LINEA PRO
PRO LINE

320 Attrezzi spaccalegna
Wood splitting tools

326 Seghetti
Hacksaws

Lavorazione del legno

Wood processing

Attrezzi spaccalegna

Wood splitting tools

660016 MAZZA SCURE MANICO FIBRA SLPITTING MAUL FIBER HANDLE



- ♦ Lama in acciaio forgiato e verniciato, robusta e pesante per spaccare tronchi di grandi e medie dimensioni
Forged and painted steel blade, sturdy and heavy for splitting large and medium-sized trunks
- ♦ Manico lungo in fibra con impugnatura in gomma per una presa salda e sicura durante il suo utilizzo, testa ad occhio ovale
Long fiber handle with rubber grip for grip firm and safe during its use, head with oval eye
- ♦ Doppio uso
Double use

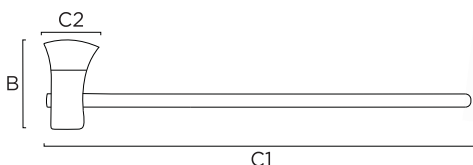

Codice	C2 X B mm	C1 mm	gr		Barcode
660016	105 x 210	910	2500	1	8033183555045

660018 MAZZA SCURE MANICO LEGNO SLPITTING MAUL WOODEN HANDLE

- ♦ Lama in acciaio forgiato e verniciato, robusta e pesante per spaccare tronchi di grandi e medie dimensioni
Forged and painted steel blade, sturdy and heavy for splitting large and medium-sized trunks
- ♦ Manico lungo in legno di faggio, levigato e sagomato per una presa più salda, testa ad occhio ovale
Long handle in polished and shaped beech wood for a grip firmer, oval eye head
- ♦ Doppio uso
Double use

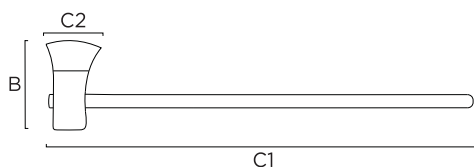

Codice	C2 X B mm	C1 mm	gr		Barcode
660018	105 x 210	900	2500	1	8033183556387
670070M	Manico ricambio / replacement handle	900		10	8033183846280

670066 ASCIA MANICO FIBRA SPLIT AXE FIBER HANDLE



- ♦ Lama in acciaio forgiato e verniciato, leggera e sottile per tagli più precisi su tronchi di piccole e medie dimensioni
Forged and painted steel blade, light and thin for longer cuts precise on small and medium sized logs
- ♦ Manico lungo in fibra con impugnatura in gomma per una presa salda e sicura durante il suo utilizzo, testa ad occhio ovale
Long fiber handle with rubber grip for grip firm and safe during its use, head with oval eye

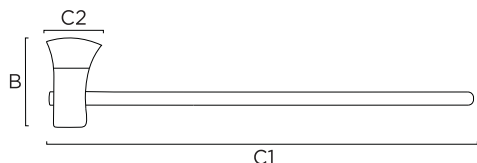

Codice	C2 X B mm	C1 mm	gr		Barcode
670066	120 x 220	910	1400	1	8033183580368

670070 ASCIA MANICO LEGNO SPLIT AXE WOOD HANDLE

- ♦ Lama in acciaio forgiato e verniciato, leggera e sottile per tagli più precisi su tronchi di piccole e medie dimensioni
Forged and painted steel blade, light and thin for longer cuts precise on small and medium sized logs
- ♦ Manico lungo in legno di faggio, levigato e sagomato per una presa più salda, testa ad occhio ovale
Long handle in polished and shaped beech wood for a grip firmer, oval eye head

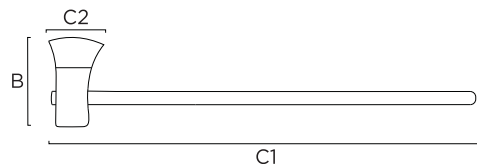

Codice	C2 X B mm	C1 mm	gr		Barcode
670070	130 x 230	910	1400	1	8033183556636

670058 MAZZA A GEMMA MANICO FIBRA SPLITTING MAUL FIBER HANDLE



- ♦ Lama in acciaio forgiato con rivestimento di colore nero di alta qualità e tagliente spigolato e lucidato
Forged steel blade with high black color coating quality and polished edged
- ♦ Manico lungo in fibra con impugnatura in gomma per una presa salda e sicura durante il suo utilizzo, testa ad occhio ovale
Long fiber handle with rubber grip for grip firm and safe during its use, head with oval eye



Codice	Peso testa / Head weight gr	C2 X B mm	C1 mm	gr		Barcode
670058	4000	60 x 200	900	5000	1	8033183554239
670058MP	Manico ricambio / Replacement handle		900	1000	10	8033183560537



670069 MAZZA COPPIA IN FIBRA PAIR OF FIBER BAT

- Testa quadra piana in acciaio temprato a induzione con superfici laterali levigate per evitare la scheggiatura del materiale
Flat square head in induction hardened steel with surfaces sides smoothed to avoid chipping of the material
- Manico lungo in fibra con impugnatura in gomma per una presa salda e sicura durante il suo utilizzo, testa ad occhio ovale
Long fiber handle with rubber grip for grip firm and safe during its use, head with oval eye



Codice	Peso testa / Head weight gr	mm	gr		Barcode
670069	3000	900	4000	1	8033183571168
670064	4000	900	5000	1	8033183568267
670065	5000	900	6000	1	8033183571151
670058MP	Manico ricambio / replacement handle	900	1000	10	8033183560537

670063 MAZZA COPPIA MANICO LEGNO PAIR WOOD HANDLE BAT

- Testa quadra piana in acciaio temprato a induzione con superfici laterali levigate per evitare la scheggiatura del materiale
Flat square head in induction hardened steel with surfaces sides smoothed to avoid chipping of the material
- Manico lungo in legno di faggio, levigato e sagomato per una presa più salda, testa ad occhio ovale
Long handle in polished and shaped beech wood for a grip firmer, oval eye head



Codice	Peso testa / Head weight gr	mm	gr		Barcode
670063	3000	900	4800	1	8033183846310
660065	Manico ricambio / replacement handle	900	800	10	8033183599094

660017 CUNEO SPACCALEGNA WEDGE SPLITTER

- In acciaio forgiato a tagliente lucido
In forged steel with polished edge



Codice	mm	gr		Barcode
660017	230 x 50	1500	5	8033183556288
670017	240 x 50	2000	5	8033183832962

670067 ACETTA SPACCALEGNA MANICO FIBRA
WOODCUTTER AXE WITH FIBER HANDLE



- ♦ Lama in acciaio forgiato e verniciato a tagliente lucido affilato a mano con protezione
Forged and painted steel blade with hand-sharpened glossy edge with protection
- ♦ Manico in fibra con impugnatura in gomma
Fiber handle with rubber grip



Codice	Codice	mm	gr		Barcode
670067		370	600	6	8033183580375

670061 ACETTA SPACCALEGNA MANICO LEGNO
WOODCUTTER AXE WITH WOODEN HANDLE

- ♦ Lama in acciaio forgiato e verniciato a tagliente lucido affilato a mano con protezione
Forged and painted steel blade with hand-sharpened glossy edge with protection
- ♦ Manico ergonomico in legno
Ergonomic wooden handle



Codice	Codice	mm	gr		Barcode
670061		300	600	6	8033183582195

670071 MANARESSO
MANARESSO

- ♦ Lama affilata a mano in acciaio forgiato e temperato
Hand sharpened blade in forged and tempered steel
- ♦ Manico ergonomico in cuoio con salvamanico
Ergonomic leather handle with protective handle



Codice	Codice	Lama / Blade mm	gr		Barcode
670071		240	660	3	8033183838285

670060 RONCOLA DA TAGLIO
CUTTING BILL

- ♦ Lama affilata a mano in acciaio forgiato e temperato
Hand sharpened blade in forged and tempered steel
- ♦ Manico ergonomico in cuoio con salvamanico
Ergonomic leather handle with protective handle



Codice	Codice	Lama / Blade mm	gr		Barcode
670060		300	570	5	8033183552983

670072 RONCOLINA MANICO LEGNO
RONCOLINA WOODEN HANDLE

- ♦ Lama affilata a mano in acciaio forgiato e temperato
Hand sharpened blade in forged and tempered steel
- ♦ Manico ergonomico in legno verniciato rosso
Ergonomic handle in red painted wood



Codice	Codice	Lama / Blade mm	gr		Barcode
670072		115	3	3	8033183838292



124103 RONCOLA SERRAMANICO PROFESSIONALE PROFESSIONAL SWITCHBLADE BILLHOOK

- ◆ Roncola serramanico con lama ricurva in acciaio temperato al carbonio, affilata a mano, con elevata capacità di taglio e una lunga durata del filo
Switchblade billhook with curved carbon steel blade, hand sharpened with high cutting capacity and long service life of the thread
- ◆ Impugnatura in legno di faggio
Beech wood handle

Codice	Lama / Blade mm		Barcode
124103	50	3	8033183554864
124104	60	3	8033183554437
124105	70	3	8033183553522
124106	80	3	8033183553508
124107	90	3	8033183553539
124108	100	3	8033183553546
124109	110	3	8033183555861



201001F FALCINO FISSO PROFESSIONALE PROFESSIONAL FIXED HAWK

- ◆ Lama ricurva in acciaio temperato al carbonio, affilata a mano, con elevata capacità di taglio e una lunga durata del filo
Curved carbon steel blade, sharpened by hand with high cutting capacity and long wire life
- ◆ Impugnatura ergonomica in legno di faggio o in cuoio grezzo
Ergonomic handle in beech wood or raw leather

Codice		Lama / Blade mm		Barcode
201001F	Manico in legno / Wooden handle	80	2	8032636334268
201002F	Manico in legno / Wooden handle	100	2	8033183580559
201101F	Manico in cuoio / Leather handle	90	2	8033183568816
201102F	Manico in cuoio / Leather handle	100	2	8033183562814



127301 SCAVINO PER LEGNO DIGGING FOR WOOD

- ◆ Lama a cucchiaio in acciaio temperato al carbonio, affilata a mano, con elevata capacità di taglio e una lunga durata del filo
Hand sharpened carbon steel spoon blade with high cutting capacity and long wire life
- ◆ Impugnatura in legno
Wooden handle

Codice	Lama / Blade mm		Barcode
127301	60	2	8033183553386



130000 COLTELLINO PROFESSIONALE RICHIUDIBILE PROFESSIONAL FOLDABLE KNIFE

- ◆ Lama in acciaio INOX
Stainless steel blade
- ◆ Manico ergonomico in materiale plastico
Ergonomic handle in plastic material

Codice	Lama / Blade mm		Barcode
130000	65	3	8033183575937



128301 COLTELLO PROFESSIONALE BERGAMASCO PROFESSIONAL KNIFE BERGAMASCO



- Coltello professionale bergamasco a lama richiudibile in acciaio temperato al carbonio con finitura a specchio, affilata a mano, con elevata capacità di taglio e una lunga durata del filo
Professional Bergamasco knife with resealable steel blade carbon tempered with mirror finish, hand sharpened, high cutting capacity and long life of the line
- Impugnatura in legno di faggio con serramanico che permette di bloccare la lama anche da chiusa
Handle in beech wood with folding handle that allows you to lock the blade even when closed

Codice	Lama / Blade mm		Barcode
128301	90	3	8033183552303
128302	100	3	8033183552310
128303	90	3	8033183552327
128304	100	3	8033183552266



130001 COLTELLO PER FUNGHI KNIFE FOR MUSHROOMS



- Coltello per funghi a lama richiudibile in acciaio temperato affilata a mano, con elevata capacità di taglio e una lunga durata del filo
Sharpened hardened steel knife for mushrooms with resealable blade by hand, high cutting capacity and long life of the wire
- Impugnatura in legno di faggio con spazzola di setole naturali, ideale per rimuovere facilmente il terriccio
Beech wood handle with natural bristle brush ideal for easily removing soil

Codice	Pezzi / Pieces	Lama / Blade mm		Barcode
130001		75	2	8033183552242
130002		75	2	8033183552280
131001	12	Espositore / Exhibitor art. 130001		8033183553799
131002	12	Espositore / Exhibitor art. 130002		8033183568625



131003 ESPOSITORE COLTELLI ASSORTITI EXHIBITOR OF ASSORTED KNIVES



Codice	Pezzi / Pieces		Barcode
131003	24 2 x 124103 - 04 - 05 - 06 - 07 - 08 3 x 128301 - 02 3 x 130001 - 02	1	8033183568632



124101R CARTELLA ESPOSITIVA EXHIBITION FOLDER

Codice		Barcode
124101R	1	8033183553515



Seghetti

Hacksaws

181599 SEGHETTO BILAMA FISSO FIXED DOUBLE BLADE SAW

- Corpo a sezione ovale in acciaio con verniciatura ad alta protezione
Body with oval section in steel with high protection paint
- Doppia lama (1 per legno e 1 per ferro)
Double blade (1 for wood and 1 for iron)
- Leva di tensione a sgancio rapido
Quick release tension lever

Codice	Lama / Blade mm	gr	Barcode
181599	300	5	8033183592026
181599R	Lama ricambio per legno / <i>Spare blade for wood</i>	300	10 8033183597939
181599RR	Set lama ricambio per legno + ferro / <i>Spare blade set for wood + iron</i>	300	10 8033183840936



181600 SEGHETTO A LAMA GIREVOLE REVOLVING BLADE SAW

- Corpo a sezione ovale in acciaio con verniciatura ad alta protezione
Body with oval section in steel with high protection paint
- Lama girevole in acciaio temperato con dente a castello per legno verde e umido
Revolving blade in tempered steel with castle tooth for wood green and wet
- Robusto perno per la regolazione della lama
Sturdy pin for blade adjustment
- Leva di tensione a sgancio rapido
Quick release tension lever

Codice	Lama / Blade mm	gr	Barcode
181600	450	500	5 8033183553218
181601	530	600	5 8033183552976
181601G	530	600	5 8033183576699
181602	610	650	5 8033183552969
181600R	Lama ricambio per legno / <i>Spare blade for wood</i>	450	10 8033183553225
181601R	Lama ricambio a castello per legno / <i>Spare bunk blade for wood</i>	530	10 8033183555106
181601GR	Lama ricambio a triangolo per legno / <i>Replacement triangle blade for wood</i>	530	10 8033183576705
181602R	Lama ricambio per legno / <i>Spare blade for wood</i>	610	10 8033183556226



181605 SEGHETTO A LAMA FISSA FIXED BLADE SAW

- Corpo a sezione ovale in acciaio con verniciatura ad alta protezione
Body with oval section in steel with high protection paint
- Robusto perno per la regolazione della lama
Sturdy pin for blade adjustment
- Attacco portalama fisso
Fixed blade holder attachment

Codice	Lama / Blade mm	gr	Barcode
181605	530	450	5 8033183552952
181606	610	500	5 8033183554598
181607	760	600	5 8033183568458
181608	800	650	5 8033183568779
181607R	Lama ricambio per legno / <i>Spare blade for wood</i>	760	10 8033183568762
181608R	Lama ricambio per legno / <i>Spare blade for wood</i>	800	10 8033183568786



230882 SEGHETTO PROFESSIONALE RICHIUDIBILE
PROFESSIONAL FOLDABLE SAW



- ♦ Lama dritta in acciaio ad alto contenuto di carbonio a tripla dentatura che permette il taglio in entrambe le direzioni
Straight blade in high carbon steel with triple teeth which allows cutting in both directions
- ♦ Manico in polipropilene con impugnatura in materiale antiscivolo
Polypropylene handle with grip in non-slip material
- ♦ Pulsante autoblocco
Self-locking button



Codice	Lama / Blade mm	gr		Barcode
230882	180	190	6	8033183574756

660031 SEGHETTO ECONOMICO RICHIUDIBILE
ECONOMIC SEALABLE SAW

- ♦ Lama dritta in acciaio ad alto contenuto di carbonio a tripla dentatura che permette il taglio in entrambe le direzioni
Straight blade in high carbon steel with triple teeth which allows cutting in both directions
- ♦ Manico in polipropilene con impugnatura in materiale antiscivolo
Polypropylene handle with grip in non-slip material
- ♦ Pulsante autoblocco
Self-locking button



Codice	Lama / Blade mm	gr		Barcode
660031	150	190	6	8033183575838

230883 SEGHETTO PROFESSIONALE LAMA FISSA
PROFESSIONAL FIXED BLADE SAW



- ♦ Lama dritta in acciaio ad alto contenuto di carbonio a tripla dentatura che permette il taglio in entrambe le direzioni
Straight blade in high carbon steel with triple teeth which allows cutting in both directions
- ♦ Manico in polipropilene con impugnatura in materiale antiscivolo
Polypropylene handle with grip in non-slip material
- ♦ Con fodero di protezione
With protective sheath



Codice	Lama / Blade mm	gr		Barcode
230883	330	300	6	8033183575029

660011 SEGHETTO LAMA FISSA IN TEFLON FIXED

- ♦ Lama dritta in acciaio ad alto contenuto di carbonio con rivestimento antiaderente e antiruggine in Teflon
High carbon steel straight blade with coating non-stick and anti-rust in Teflon
- ♦ Manico in polipropilene con impugnatura in materiale antiscivolo
Polypropylene handle with grip in non-slip material
- ♦ Con fodero di protezione
With protective sheath

Codice	Lama / Blade mm	gr		Barcode
660011	330	340	6	8033183554543



671030 SEGACCIO A LAMA FISSA FIXED BLADE SAW

- ♦ Lama retta in acciaio con dentatura a castello affilata
Straight steel blade with sharp castle teeth
- ♦ Manico in ferro verniciato ad ombrello che consente una presa meno soggetta a vibrazioni
Umbrella painted iron handle that allows one grip less subject to vibrations

Codice	Lama / Blade mm		Barcode
671030	300	3	8033183553096
671035	350	3	8033183553102
671040	400	5	8033183559586



670030 SEGACCIO A LAMA FISSA FIXED BLADE SAW

- ♦ Lama di forma trapezoidale in acciaio con dentatura fine
Trapezoidal shaped steel blade with fine toothing
- ♦ Tradizionale manico ergonomico in plastica
Traditional ergonomic plastic handles

Codice	Lama / Blade mm	gr		Barcode
670030	300	180	6	8033183554123
670035	350	210	6	8033183554130
670040	400	250	6	8033183554147



FUNZIONI INNOVATIVE PER LAVORI DI QUALITA'

INNOVATIVE FUNCTIONS FOR QUALITY WORK



LINEA PRO
PRO LINE

330 Scope per foglie
Brooms for leaves

332 Taglio dell'erba
Grass cutting

Cura del prato

Lawn care

Scope per foglie

Broom leaves

660007M SCOPA DA GIARDINO REGOLABILE ADJUSTABLE GARDEN BROOM

- ♦ Corpo in acciaio zincato con 22 denti piatti regolabili che si adattano al livello del terreno
Galvanized steel body with 22 adjustable teeth that fit the ground level
- ♦ Attacco a morsetto \varnothing 25mm
Clamp connection \varnothing 25mm

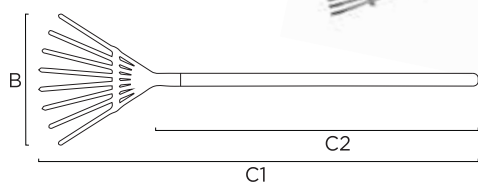

Codice	Denti / Teeth	B mm	C1 / C2 mm	📦	Barcode
660007M	22	Con manico / Replacement handle	1830	6	8033183599070
660007	22	Testa / Head	Da 280 a 460	6	8033183554994
660053		Manico ricambio / Spare handle	1500		8033183576651



670029M SCOPA DA GIARDINO FISSA ADJUSTABLE GARDEN BROOM

- ♦ Corpo in acciaio zincato con 22 denti piatti fissi, con rinforzo centrale, che si aprono a ventaglio
Galvanized steel body with 22 fixed teeth with central reinforcement that they fan out
- ♦ Attacco conico \varnothing 25mm
Conical attachment \varnothing 25mm

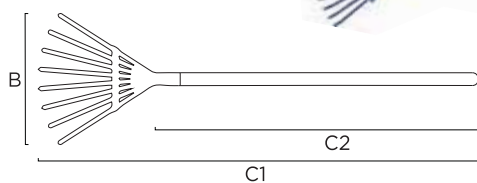

Codice	Denti / Teeth	B mm	C1 / C2 mm	📦	Barcode
670029M	22	Con manico / Replacement handle	1830	6	8033183599063
670029	22	Testa / Head	470	6	8033183552792
660053		Manico ricambio / Spare handle	1500		8033183576651



670027 SCOPA NOVITA' SENZA MANICO
NEW BROOM WITHOUT HANDLE

- Corpo in plastica con 20 denti in acciaio, tondi fissi ed elastici, che si aprono a ventaglio
Plastic body with 20 fixed and elastic round steel teeth they fan out
- Attacco conico \varnothing 28mm
Conical attachment n \varnothing 28mm

Codice	Denti / Teeth	mm		Barcode
670027	20	220 x 430	6	8033183575944

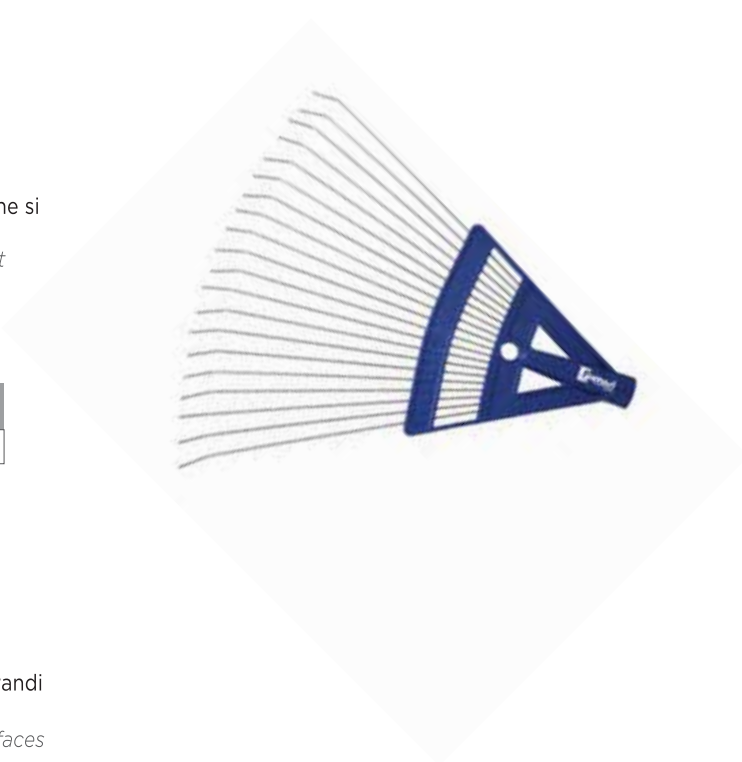

670039 SCOPA DA GIARDINO XL
GARDEN BROOM XL

- Corpo in plastica rigida con 27 denti piatti e fissi, ideale per le grandi superfici grazie alla larghezza della testa di 650mm
Rigid plastic body with 27 flat and fixed teeth ideal for big girls surfaces thanks to the head width of 650mm
- Manico leggero in fibra di vetro per un lavoro senza sforzo
Lightweight fiberglass handle for effortless work



Codice	Denti / Teeth	mm		Barcode	
670039	27	Con manico / Replacement handle	1300 x 650	6	8033183833303

670026 SCOPA DA GIARDINO XL
GARDEN BROOM XL

- Corpo in plastica con 25 denti piatti fissi
Galvanized steel body with 22 adjustable teeth that fit the ground level
- Attacco conico \varnothing 25mm
Clamp attachment \varnothing 25mm



Codice	Denti / Teeth	B mm	C1 / C2 mm		Barcode
670026	25	Con manico / Replacement handle	1660	6	8033183837820
670026SM	25	Testa / Head	510	6	8033183836830
660053		Manico ricambio / Spare handle	1500		8033183576651

670033 SCOPA PER ESTERNI SENZA MANICO
BROOM FOR OUTDOOR USE WITHOUT HANDLE

- Scopa in plastica verde senza manico con ghiera a struttura a zampa di lepore, composta da fili in polipropilene verdi ingabbiati su supporto plastico
Green plastic broom without handle with ring nut with structure hare-footed, made of caged green polypropylene threads on plastic support
- Attacco conico \varnothing 25mm
Conical connection \varnothing 25mm



Codice	mm		Barcode
670033	600	6	8033183575968

Taglio dell'erba

Taglio dell'erba

660047 FALCE
SICKLE

- Lama curva in acciaio con portezione
Curved steel blade with doors
- Manico curvo d'acciaio con anello per il fissaggio della lama della falce
Curved steel handle with ring for the attachment of the scythe blade
- Disponibile pietra cote per affilatura
Available whetstone for sharpening



Codice	mm		Barcode
660047	1500 x 600	6	8033183599117
660045	Pietra per affilatura lama / <i>Blade sharpening stone</i>	3	8033183583154

670062 FALCETTO PER ERBA
SICKLE FOR GRASS

- Lama a mezzaluna in acciaio affilata a mano con protezione
Hand sharpened steel crescent blade with protection
- Manico in legno di faggio
Beech wood handle

Codice	mm		Barcode
670062	350 x 230	5	8033183552914



670092 FALCETTO PER CANTONIERE
SOCKET FOR CANTONIERE

- Lama a mezzaluna in acciaio forgiato affilata a mano con protezione
Hand sharpened steel crescent blade with protection
- Manico lungo in legno
Beech wood handle

Codice	mm		Barcode
670092	610 x 300	6	8033183833006



223949 FORBICI TAGLIAERBA A LAME GIREVOLI
LAWN MOWER SCISSORS WITH REVOLVING BLADES

- ♦ Lame in acciaio INOX
Stainless steel blades
- ♦ Lame girevoli a 360° permettono di raggiungere facilmente gli angoli più nascosti
360° rotating blades allow you to easily reach the more hidden corners
- ♦ Manico ergonomico in plastica rinforzata con anello di protezione delle dita nella parte inferiore dell'impugnatura
Ergonomic handle in reinforced plastic with protective ring of the fingers at the bottom of the handle
- ♦ Pulsante per facilitare l'apertura della lama
Button to facilitate the opening of the blade



Codice	Lama / Blade mm	mm		Barcode
223949	140	335	6	8033183575821

223939R FORBICI TAGLIAERBA A LAME GIREVOLI
LAWN MOWER SCISSORS WITH REVOLVING BLADES

- ♦ Lame in acciaio con rivestimento antiaderente
Non-stick coated steel blades
- ♦ Lame girevoli a 180° per un taglio sia orizzontale che verticale
180° rotating blades for both horizontal and vertical cutting
- ♦ Manico in metallo verniciato
Painted metal handle
- ♦ Molla di ritorno
Return spring



Codice	Lama / Blade mm	mm		Barcode
223949R	150	320	12	8033183553027

223951 FORBICI TAGLIAERBA A LAMA ONDULATE GIREVOLI
ROTATING CORRUGATED BLADE MOWER SCISSORS

- ♦ Lame in acciaio INOX con affilatura ondulata
Stainless steel blades with wavy sharpening
- ♦ Lame girevoli a 360° permettono di raggiungere facilmente gli angoli più nascosti
360° rotating blades allow you to easily reach the more hidden corners
- ♦ Manico ergonomico in plastica rinforzata con anello di protezione delle dita nella parte inferiore dell'impugnatura
Ergonomic handle in reinforced plastic with protective ring of the fingers at the bottom of the handle
- ♦ Pulsante per facilitare l'apertura della lama
Button to facilitate the opening of the blade



Codice	Lama / Blade mm	mm		Barcode
223951	140	350	6	8033183591883



ATTREZZI ROBUSTI DA GIARDINO

STURDY GARDEN TOOLS



LINEA PRO
PRO LINE

- 335** Utensili per dissodare e scavare il terreno
Tillage tools e dig up the ground
- 339** Utensili per la raccolta agricola
Agricultural harvesting tools
- 341** Manici di ricambio
Replacement handles

Cura del terreno

Ground care

Dissodare e scavare il terreno

Till and dig the soil

600000 ZAPPA A CUORE

HEART HOE

- ♦ Corpo in acciaio forgiato realizzato in un unico pezzo, levigato e affilato per una facile lavorazione del terreno
Forged steel body made in one piece, polished and sharp for easy tillage
- ♦ Occhio tondo \varnothing 35mm
Round eye \varnothing 30mm
- ♦ Manico in legno di faggio
Beech wood handle

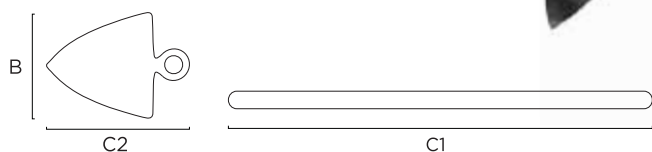

Codice		C2 x B mm	C1 mm	gr		Barcode
600000	Con manico / With handle	230 x 180	1250	800	3	8033183591586
660054	Manico ricambio / Replacement handle			550	5	8033183576668

660001 ZAPPA QUADRA

SQUARE HOE

- ♦ Corpo in acciaio forgiato realizzato in un unico pezzo, levigato e affilato per una facile lavorazione del terreno
Forged steel body made in one piece, polished and sharp for easy tillage
- ♦ Occhio tondo \varnothing 35mm
Round eye \varnothing 30mm

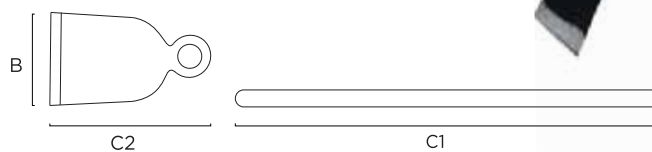

Codice		C2 x B mm	C1 mm	gr		Barcode
660001	Con manico / With handle	250 x 120	1250	1800	3	8033183556899
660001M	Testa / Head	250 x 120		800	6	8033183556448
660054	Manico ricambio / Replacement handle		1250		5	8033183576668

660002 ZAPPINO A QUADRO CON BIDENTE

HE

- ♦ Realizzato in un unico pezzo in acciaio forgiato, levigato e affilato con denti rinforzati

Made in a single piece of forged steel, honed and sharpened with reinforced teeth

- ♦ Occhio tondo ø 30mm

Round eye ø 30mm

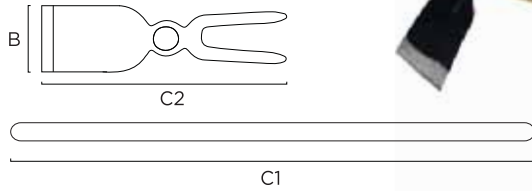

Codice		C2 x B mm	C1 mm	gr		Barcode
660002	Con manico / With handle	365 x 80	1250	1350	3	8033183571106
660051	Testa / Head	365 x 80		550	6	8033183576613
660055	Manico ricambio / Replacement handle		1250		5	8033183576675

660034 ZAPPINO A CUORE CON BIDENTE

HEART HOUSE WITH BIDENT

- ♦ Realizzato in un unico pezzo in acciaio forgiato, levigato e affilato con denti rinforzati

Made in a single piece of forged steel, honed and sharpened with reinforced teeth

- ♦ Occhio tondo ø 30mm

Round eye ø 30mm

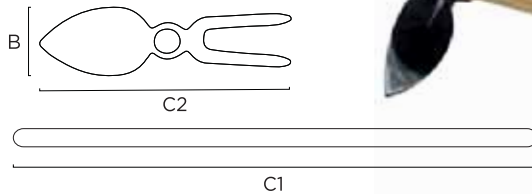

Codice		C2 x B mm	C1 mm	gr		Barcode
660034	Con manico / With handle	380 x 80	1250	1350	3	8033183577757
660057	Testa / Head	380 x 80		550	6	8033183578976
660055	Manico ricambio / Replacement handle		1250		5	8033183576675

660004M VANGA A PUNTA FORGIATA

FORGED POINT SPAD

- ♦ Realizzata in acciaio forgiato di alta qualità

Made of high quality forged steel

- ♦ Spalla con risvolto

Shoulder with turn-up

- ♦ Attacco tondo ø 30mm

Round connection ø 30mm

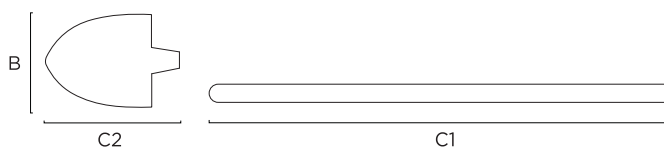

Codice		C2 x B mm	C1 mm	gr		Barcode
660004M	Con manico / With handle	390 x 240	1700	2500	3	8033183560988
660004	Testa / Head	390 x 240		1500	6	8033183556196
660052	Manico ricambio / Replacement handle		1400		5	8033183576644

660002M VANGA A PUNTA TEMPRATA HARDENED POINT SPADE

- ♦ Punta in acciaio temprato verniciato
Painted hardened steel tip
- ♦ Attacco tondo \varnothing 40mm
Round connection \varnothing 40mm

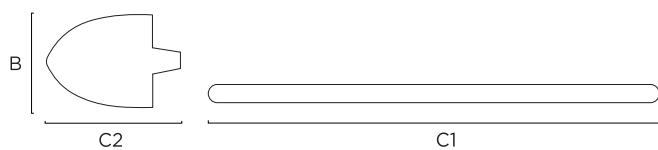

Codice		C2 x B mm	C1 mm	gr		Barcode
660002M	Con manico / <i>With handle</i>	370 x 250	1700	2100	3	8033183833013
660002SM	Testa / <i>Head</i>	370 x 250		1100	6	8033183886822
660052	Manico ricambio / <i>Replacement handle</i>		1400		5	8033183576637



660003M VANGA VARESE A PUNTA QUADRA FORGIATA FORGED SQUARE POINT VARESE SPADEL

- ♦ Realizzata in acciaio forgiato di alta qualità
Made of high quality forged steel
- ♦ Spalla con risvolto
Shoulder with turn-up
- ♦ Attacco tondo \varnothing 30mm
Round connection \varnothing 30mm

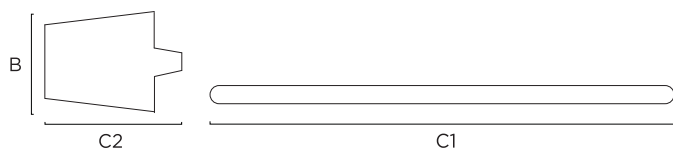

Codice		C2 x B mm	C1 mm	gr		Barcode
660003M	Con manico / <i>With handle</i>	355 x 210	1745	2800	3	8033183571113
660003	Testa / <i>Head</i>	355 x 210		1800	6	8033183554857
660052	Manico ricambio / <i>Replacement handle</i>		1400		5	8033183576644



660015M BADILE IN ACCIAIO TEMPERATO SHELF IN TEMPERED STEEL

- ♦ Realizzata in acciaio temprato di alta qualità
Made of high quality hardened steel
- ♦ Attacco tondo \varnothing 35mm
Round connection \varnothing 35mm

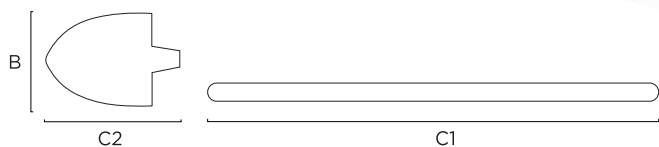

Codice		C2 x B mm	C1 mm	gr		Barcode
660015M	Con manico / <i>With handle</i>	350 x 280	1745	2200	3	8033183563415
660015	Testa / <i>Head</i>	350 x 280		1200	6	8033183554703
660050	Manico ricambio / <i>Replacement handle</i>		1400		5	8033183576637





660035M BADILE IN ACCIAIO FORGIATO SHELF IN FORGED STEEL

- Realizzata in acciaio temperato di alta qualità
Made of high quality hardened steel
- Attacco tondo Ø 35mm
Round connection Ø 35mm

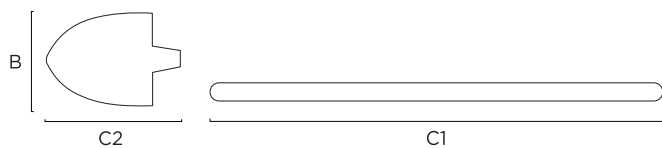

Codice		C2 x B mm	C1 mm	gr		Barcode
660035M	Con manico / <i>With handle</i>	390 x 240	1780	2500	3	8033183577740
660035	Testa / <i>Head</i>	390 x 240		1500	6	8033183590237
660050	Manico ricambio / <i>Replacement handle</i>		1400		5	8033183576637



670057 PICCONE MANICO IN FIBRA PEAK WITH FIBER HANDLE

- Realizzata in acciaio forgiato di alta qualità a lama lucida
Made of high quality forged steel with a polished blade
- Manico in fibra di vetro
Fiberglass handle
- Occhio ovale
Oval eye

Codice		mm	gr		Barcode
670057	Con manico / <i>With handle</i>	900 x 465	1500	1	8033183554222
670057MP	Manico ricambio / <i>Replacement handle</i>	900 x 80		5	8033183571137



660014 PICCONE MANICO IN LEGNO PEAK WITH WOODEN HANDLE

- Realizzata in acciaio forgiato di alta qualità a lama lucida
Made of high quality forged steel with a polished blade
- Manico in legno di faggio
Beech wood handle
- Occhio ovale
Oval eye

Codice		mm	gr		Barcode
660014	Con manico / <i>With handle</i>	900 x 465	1150	5	8033183556639
670057M	Manico ricambio / <i>Replacement handle</i>	900 x 80		5	8033183563538



Raccolta agricola

Agricultural harvest

660036 FORCA TRIDENTE

TRIDENT FORK

- ♦ Corpo in acciaio verniciato in oro con 3 denti a profilo ovale
Steel body painted in gold with 3 oval profile teeth
- ♦ Attacco tondo \varnothing 30mm
Round connection \varnothing 30mm
- ♦ Manico in legno di faggio
Beech wood handle



Codice		mm	gr		Barcode
600036	Con manico / With handle	1700 x 240	1580	3	803318357771

660039 FORCA A 4 DENTI

FORK WITH 4 TEETH

- ♦ Corpo in acciaio verniciato in oro con 4 denti a profilo ovale
Blue painted steel bo
- ♦ Attacco tondo \varnothing 30mm
Round connection \varnothing 30mm
- ♦ Manico in legno di faggio
Beech wood handle



Codice		mm		Barcode
600039	Con manico / With handle	1740 x 210	3	8033183583352

660038 FORCA A 4 DENTI

FORK WITH 4 TEETH

- ♦ Corpo in acciaio verniciato blu con 4 denti quadrangolari
Blue painted steel body with 4 quadrangular teeth
- ♦ Attacco tondo \varnothing 30mm
Round connection \varnothing 30mm
- ♦ Manico in legno di faggio
Beech wood handle



Codice		mm		Barcode
600038	Con manico / With handle	1700 x 190	3	8033183599100

670048M RASTRELLO IN FERRO A DENTI CURVI IRON RAKE WITH CURVED TEETH

- Corpo in ferro verniciato lucido blu altamente resistente, con denti piatti leggermente ricurvi
Highly resistant blue glossy painted iron body with teeth slightly curved plates
- Attacco conico \varnothing 25mm
Conical connection \varnothing 25mm

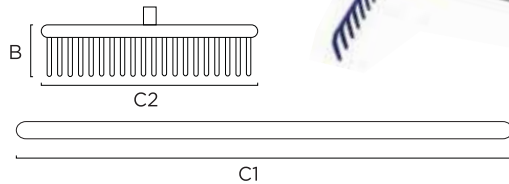

Codice	Denti / Teeth		C2 x B mm	C1 mm		Barcode
670048M	16	Con manico / With handle	410 x 80	1530	3	8033183575975
670048	16	Testa / Head	410 x 80		6	8033183576903
670050M	14	Con manico / With handle	350 x 80	1530	3	8033183832955
670050	14	Testa / Head	350 x 80		6	8033183555427
660053	Manico ricambio / Replacement handle			1500	5	8033183576651

670049M RASTRELLO IN FERRO A DENTI DRITTI IRON RAKE WITH STRAIGHT TEETH

- Corpo in ferro verniciato lucido blu altamente resistente, con denti piatti e dritti
Highly resistant blue glossy painted iron body with teeth flat and straight
- Attacco conico \varnothing 25mm
Conical connection \varnothing 25mm

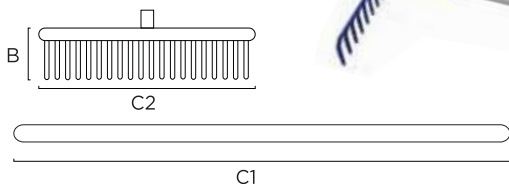

Codice	Denti / Teeth		C2 x B mm	C1 mm		Barcode
670049M	16	Con manico / With handle	410 x 80	1530	3	8033183832948
670049B	16	Testa / Head	410 x 80		6	8033183846730
660053	Manico ricambio / Replacement handle			1500	5	8033183576651

670047M RASTRELLO IN PLASTICA A DENTI CURVI CURVED TEETH PLASTIC RAKE

- Corpo in plastica con denti piatti ricurvi
Plastic body with curved flat teeth
- Attacco conico \varnothing 25mm
Conical connection \varnothing 25mm

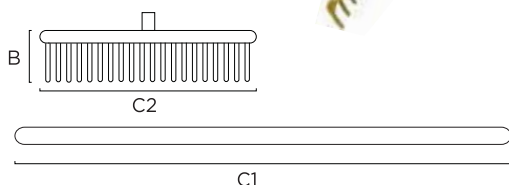

Codice	Denti / Teeth		C2 x B mm	C1 mm		Barcode
670047M	16	Con manico / With handle	410 x 80	1530	3	8033183575982
670047	16	Testa / Head	410 x 80		6	8033183576965
660053	Manico ricambio / Replacement handle			1500	5	8033183576651

670040M RASTRELLO DA FIENO VERNICIATO PAINTED HAY RAKE

- ♦ Corpo in ferro verniciato lucido blu altamente resistente, con denti piatti curvi saldati
Highly resistant blue glossy painted iron body, with teeth welded curved plates
- ♦ Attacco conico \varnothing 28mm
Conical connection \varnothing 28mm

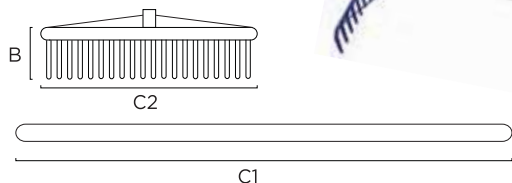

Codice	Denti / Teeth	C2 x B mm	C1 mm		Barcode
670040M	20 Con manico / With handle	770 x 120	1500	3	8033183846501
670004	20 Testa / Head	770 x 120		6	8033183843043
660053	Manico ricambio / Replacement handle		1500	5	8033183576651

670003 TESTA RASTRELLO DA FIENO PLASTIC HAY RAKE HEAD

- ♦ In plastica resistente con elevata resistenza alla corrosione e leggera, che permette all'operatore di lavorare senza eccessiva fatica
Made of durable plastic with high corrosion resistance and lightweight, which allows the operator to work without excessive fatigue
- ♦ Denti flessibili e arrotondati
Flexible and rounded teeth

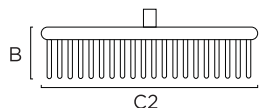

Codice	Denti / Teeth	C2 x B mm		Barcode
670003	18 Testa / Head	570 x 120	6	8033183842299

670002M RASTRELLO AREATORE DOPPIO DOUBLE AERATOR RAKE

- ♦ Corpo in acciaio verniciato a polvere con doppio pettine, composto da 32 denti in acciaio zincato (21 denti da una parte e 11 dall'altra)
Powder coated steel body with double comb, compound with 32 teeth in galvanized steel (21 teeth on one side and 11 on the other)
- ♦ Attacco conico \varnothing 28mm
Conical connection \varnothing 28mm

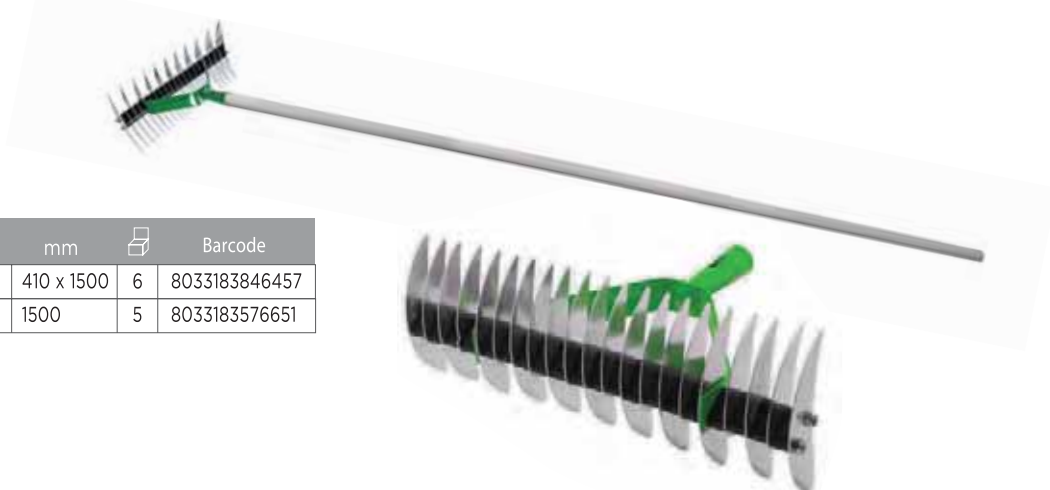

Codice	Denti / Teeth	mm		Barcode
670002M	32 Con manico / With handle	410 x 1500	6	8033183846457
660053	Manico ricambio / Replacement handle	1500	5	8033183576651

670013M SARCHIATORE 3 DENTI 3 TEETH WEEDER

- ♦ Corpo in ferro verniciato blu con 3 denti ricurvi ad uncino con punta tonda, (dente centrale più profondo, i due laterali sono allineati)
Blue painted iron body with 3 curved hooked teeth with tip round, (deeper central tooth, the two laterals are aligned)
- ♦ Attacco conico \varnothing 28mm
Conical connection \varnothing 28mm



Codice	Denti / Teeth	mm		Barcode	
670013M	3	Con manico / With handle	1400 x 120	3	8033183846471

670014M SARCHIATORE A COLLO DI CIGNO GOOSE NECK WEEDER

- ♦ Corpo in ferro verniciato blu con 2 braccia e una lama
Blue painted iron body with 2 arms and a blade
- ♦ Attacco conico \varnothing 24mm
Conical connection \varnothing 24mm

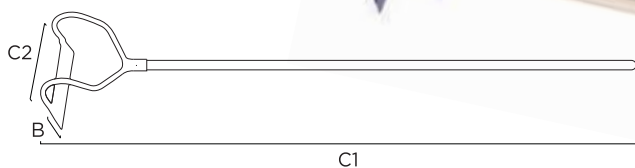

Codice	C2 x B mm	C1 mm		Barcode	
670014M	Con manico / With handle	160 x 40	1400	3	8033183846488

670018 RASPAFANGO IN LAMIERA SHEET MUD RUBBER

- ♦ Corpo in lamiera zincata
Body in galvanized sheet



Codice	mm		Barcode
670018	115 x 400	3	8033183846495

Manici in faggio

Beech handles

660050 MANICO CURVO PER BADILE
CURVED SHELF HANDLE



Codice	∅ mm	mm	gr		Barcode
660050	35	1400	800	5	8033183576637

660052 MANICO DIRITTO PER VANGHE
STRAIGHT HANDLE FOR SPADES



Codice	∅ mm	mm	gr		Barcode
660052	30	1400	800	5	8033183576644

660053 MANICO DIRITTO PER SCOPE E RASTRELLI
STRAIGHT HANDLE FOR SCOPES AND RAKES



Codice	∅ mm	mm	gr		Barcode
660053	25	1500	800	5	8033183576651

660054 MANICO DIRITTO PER ZAPPE
STRAIGHT HANDLE FOR HOES



Codice	∅ mm	mm	gr		Barcode
660054	35	1250	600	5	8033183576668

660055 MANICO DIRITTO PER ZAPPINI
STRAIGHT HANDLE FOR HOES



Codice	∅ mm	mm	gr		Barcode
660055	30	1250	600	5	8033183576675

660055A MANICO DIRITTO PER ZAPPINI Ø 28mm
STRAIGHT HANDLE FOR HOES Ø 28mm



Codice	Ø mm	mm	gr		Barcode
660055A	2,8	1200	500	5	8033183832993

660066 MANICO DIRITTO PER SCOPE A VITE
STRAIGHT HANDLE FOR SCREW Brooms



Codice	Ø mm	mm	gr		Barcode
660066	25	1400	400	5	8033183832931

660064 MANICO DIRITTO PER ATTREZZI GIARDINO
STRAIGHT HANDLE FOR GARDEN TOOLS



Codice	Ø mm	mm	gr		Barcode
660064	30	1400	800	5	8033183599087

660065 MANICO PER MAZZA IN LEGNO
HANDL



Codice	Ø mm	mm	gr		Barcode
660065	35	890	500	5	8033183599094

670057M MANICO PER PICCONE IN LEGNO
WOODEN PEAK HANDLE



Codice	Ø mm	mm	gr		Barcode
670057M	35	890	500	5	8033183563538

670070M MANICO PER ASCIA IN LEGNO
WOODEN AX HANDLE



Codice	Ø mm	mm	gr		Barcode
670070M	38	890	500	5	8033183846280

IL POTERE DELL'ESTENSIONE

THE POWER OF EXTENSION



LINEA PRO
PRO LINE



DISPONIBILE LAMA DI RICAMBIO
SPARE BLADE AVAILABLE



ARTICOLO AMMORTIZZATO
CUSHIONED ITEM

- 344** Troncarami linea professionale
Professional line lopper
- 347** Troncarami linea economica
Economic line lopper
- 348** Svettatoi
Clipped
- 350** Cesioie siepi
Hedge shears

Potatura professionale

Professional pruning

Troncarami linea professionale

Professional line lopper

- 1** **Lame in acciaio con alta percentuale di carbonio, forgiate a caldo e affilate con la massima precisione.**
High carbon steel blades, hot forged and sharpened with maximum precision.
- 2** **Manici leggeri in lega di alluminio a sezione ovale con impugnatura ergonomica in bi-materiale atossico e antiscivolo.**
Lightweight oval section aluminum alloy handles with grip ergonomic in non-toxic and non-slip bi-material.

230881 TRONCARAMI PROFESSIONALE A LAMA BATTENTE CURVA

PROFESSIONAL BLADE LOPPERS CURVED SWING

- **Taglio battente** dove la lama mobile si scontra con un'incudine, svolgendo così un'azione di taglio a ghigliottina netta e pulita
Hinged cut where the movable blade collides with an anvil thus carrying out a neat and clean guillotine cutting action
- Lama intercambiabile
Interchangeable blade

Codice	mm		Barcode
230881	800	3	8033183574749
231881	Lama ricambio / Spare blade	1	8033183574862



223935 TRONCARAMI PROFESSIONALE TAGLIO BATTENTE

PROFESSIONAL BY-PASS LOPPERS WITH RATCHET

- Battente in acciaio al carbonio con rivestimento antiaderente e antiruggine in Teflon
Knocker in carbon steel with non-stick coating e anti-rust in Teflon
- **Taglio battente** dove la lama mobile si scontra con un'incudine, svolgendo così un'azione di taglio a ghigliottina netta e pulita
Hinged cut where the movable blade collides with an anvil thus carrying out a neat and clean guillotine cutting action
- Manici telescopici con leva di blocco
Telescopic handles with locking lever

Codice	mm		Barcode
223935	da 660 a 1000	3	8033116545297
223935L	Lama ricambio / Spare blade	1	8033183846723



223931 TRONCARAMI PROFESSIONALE BY PASS A CRICCHETTO
 PROFESSIONAL BY-PASS LOPPERS WITH RATCHET



- ♦ Lama superiore in acciaio al carbonio con rivestimento antiaderente e antiruggine in Teflon
Upper blade in carbon steel with non-stick coating and anti-rust in Teflon
- ♦ Azione di taglio **BY PASS** per garantire facile accesso ai rami e tagli netti
BY PASS cutting action to ensure easy access to branches and clean cuts
- ♦ Manici telescopici con leva di blocco
Telescopic handles with locking lever
- ♦ Il meccanismo a cricchetto a 4 livelli fornisce risultati di taglio eccellenti
The 4-level ratchet mechanism provides excellent cutting results

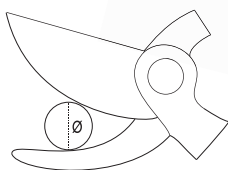



Codice	Ø mm	mm		Barcode
223931	35	da 680 a 990	3	8033116545303
223931L	Lama ricambio / Spare blade		1	8033183598875

223934 TRONCARAMI PROFESSIONALE BY PASS
 PROFESSIONAL BY-PASS LOPPERS WITH RATCHET

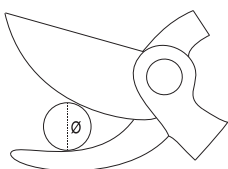

- ♦ Lama superiore in acciaio al carbonio con rivestimento antiaderente e antiruggine in Teflon
Upper blade in carbon steel with non-stick coating and anti-rust in Teflon
- ♦ Azione di taglio **BY PASS** per garantire facile accesso ai rami e tagli netti
BY PASS cutting action to ensure easy access to branches and clean cuts
- ♦ Manici telescopici con leva di blocco
Telescopic handles with locking lever



Codice	Ø mm	mm		Barcode
223934	35	da 680 a 990	3	8033116545310
223934L	Lama ricambio / Spare blade		1	8033183555526

230885 TRONCARAMI PROFESSIONALE BY PASS PROFESSIONAL BLADE LOPPERS CURVED SWING

- ♦ Azione di taglio **BY PASS** per garantire facile accesso ai rami e tagli netti
BY PASS cutting action to ensure easy access to branches and clean cuts
- ♦ Ammortizzatori in gomma per un miglior assorbimento del taglio
Rubber shock absorbers for a better cut absorption
- ♦ Lama intercambiabile
Interchangeable blade

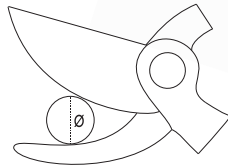



Codice	∅ mm	mm		Barcode
230885	35	600	3	8033183581242
230887	40	800	3	8033183581723

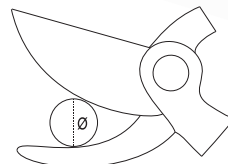

230889 TRONCARAMI PROFESSIONALE CON SISTEMA DI TAGLIO "SPECIAL LEVER" PROFESSIONAL LOPPERS WITH SYSTEM "SPECIAL LEVER" CUTTING

- ♦ Sistema di leva "Special Lever" che diminuisce lo sforzo ed assicura un taglio dolce e confortevole
"Special Lever" lever system that reduces effort and ensures a sweet and comfortable cut
- ♦ Ammortizzatori in gomma per un miglior assorbimento del taglio
Rubber shock absorbers for a better cut absorption
- ♦ Lama intercambiabile
Interchangeable blade



Codice	∅ mm	mm		Barcode
230889	40	600	3	8033183581815
230888	44	800	3	8033183581730



Troncarami **linea economica**

Economic line lopper

223919 TRONCARAMI BY PASS AD INGRANAGGI

BY-PASS LOPP-CUTTERS WITH GEARS

- ♦ Testa a uncino con lama in acciaio con rivestimento antiaderente e antiruggine in Teflon
Hook head with non-stick coated steel blade and anti-rust in Teflon
- ♦ Manici in alluminio verniciato nero a sezione ovale con manopole
Handles in black painted aluminum oval with knobs
- ♦ Azione di taglio **BY PASS** per garantire facile accesso ai rami e tagli netti
BY PASS cutting action to ensure easy access to branches and clean cuts
- ♦ Meccanismo a ingranaggi che aumenta la potenza di taglio e ottimizza la distribuzione della forza quando necessario
Gear mechanism that increases the cutting power e optimizes force distribution when needed



Codice	∅ mm	mm		Barcode
223919	40	740	6	8033183586254

223930 TRONCARAMI BY PASS AD INGRANAGGI

BY-PASS LOPP-CUTTERS WITH GEARS

- ♦ Testa a uncino con lama in acciaio con rivestimento antiaderente e antiruggine in Teflon
Hook head with non-stick coated steel blade and anti-rust in Teflon
- ♦ Manici in alluminio con impugnatura in morbida gomma
Aluminum handles with soft rubber grip
- ♦ Azione di taglio **BY PASS** per garantire facile accesso ai rami e tagli netti
BY PASS cutting action to ensure easy access to branches and clean cuts
- ♦ Meccanismo a ingranaggi che aumenta la potenza di taglio e ottimizza la distribuzione della forza quando necessario
Gear mechanism that increases the cutting power e optimizes force distribution when needed



Codice	mm		Barcode
223930	460	3	8033116545273
223936	550	3	8033116545242

Svettatoi

Cong pruner

660033 SVETTATOIO TELESCOPICO BY PASS

BY PASS TELESCOPIC HANDLE PRUNER STICK



- Testa di taglio orientabile a 180°
180° adjustable cutting head
- Lame in acciaio al carbonio con rivestimento antiaderente e antiruggine in Teflon
Carbon steel blades with non-stick coating e anti-rust in Teflon
- Azione di taglio **BY PASS** per garantire facile accesso ai rami e tagli netti
BY PASS cutting action to ensure easy access to branches and clean cuts
- Manico in alluminio allungabile con impugnatura in morbida gomma
Extendable aluminum handle with soft rubber grip
- Integrazione del filo nella struttura tubolare per una maggiore sicurezza
Integration of the wire in the tubular structure for greater safety
- Fettuccia interna e cavo in acciaio su terminale
Internal webbing and steel cable on the terminal

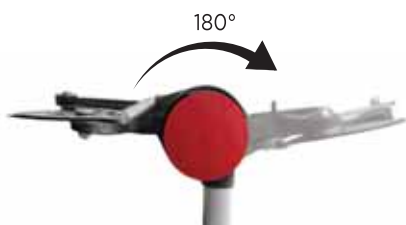

Codice	Taglio / Cut ø mm	mm		Barcode
660033	20	da 2000 a 3650	2	8033183580276

660032 SVETTATOIO PROFESSIONALE BY PASS

PROFESSIONAL BY-PASS CONG HANDLE PRUNER STICK

- Testa di taglio orientabile a 180°
180° adjustable cutting head
- Lame in acciaio al carbonio con rivestimento antiaderente e antiruggine in Teflon
Carbon steel blades with non-stick coating e anti-rust in Teflon
- Azione di taglio **BY PASS** per garantire facile accesso ai rami e tagli netti
BY PASS cutting action to ensure easy access to branches and clean cuts
- Manico in alluminio fisso con impugnatura in morbida gomma
Fixed aluminum handle with soft rubber grip
- Integrazione del filo nella struttura tubolare per una maggiore sicurezza
Integration of the wire in the tubular structure for greater safety
- Cavo in corda
Rope cable

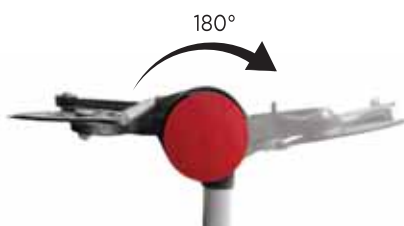

Codice	Taglio / Cut ø mm	mm		Barcode
660032	20	1625	3	8033183575814



660037 SVETTATOIO CON TESTA ORIENTABILE
PROFESSIONAL SHORT PRUNER STICK

- Testa di taglio orientabile
Adjustable cutting head
- Lame in acciaio al carbonio con rivestimento antiaderente e antiruggine in Teflon
Carbon steel blades with non-stick coating e anti-rust in Teflon
- Manico in alluminio con impugnatura in morbida gomma
Aluminum handle with soft rubber grip

Codice	Taglio / Cut Ø mm	mm		Barcode
660037	25	800	3	8033183581808



660012 SVETTATOIO A PERTICA + SEGHETTO
CUTTER + SAW

- Testa svettatoio a pertica in acciaio verniciato
Pole pruner head in painted steel
- Funzionamento a corda e dotato di sistema di scorrimento a doppia carrucola, atto a favorire l'andata e il ritorno della corda stessa e a potenziarne il taglio
Rope operation and equipped with a double sliding system pulley designed to facilitate the outward and return journey of the rope itself and a enhance cutting
- Completo di seghetto da 350 mm in acciaio
Complete with 350 mm steel hacksaw

Codice	Lama / Blade mm	mm		Barcode
660012	350	270	6	8033116545259



660012B SVETTATOIO PROFESSIONALE PER ASTA
TELESCOPICA
PROFESSIONAL SAUCER FOR AUCTION TELESCOPIC

- Lama in acciaio a dentatura triangolare
Triangular toothed steel blade
- Manico regolabile cavo per l'inserimento dell'asta
Adjustable hollow handle for inserting the rod

Codice	Lama / Blade mm	mm		Barcode
660012B	350	550	12	8033183841322



Cesoie siepi

Hedge shears

230886 CESOIA SIEPI PROFESSIONALE PROFESSIONAL HEDGE SHEAR

- ♦ Lame strette in acciaio al carbonio interamente temprate e affilate con precisione, aventi rivestimento antiaderente in Teflon
Narrow carbon steel blades fully hardened and sharpened with precision Teflon non-stick coating
- ♦ Manici leggeri in lega di alluminio a sezione ovale con impugnatura ergonomica in bi-materiale atossico e antiscivolo
Lightweight oval section aluminum alloy handles with grip ergonomic in non-toxic and non-slip bi-material
- ♦ Perno di trasmissione rettificato e temprato
Transmission pin ground and hardened
- ♦ Ammortizzatori in gomma per un miglior assorbimento del taglio
Rubber shock absorbers for a better cut absorption
- ♦ Lama intercambiabile
Interchangeable blade

Codice	mm		Barcode
230886	600	3	8033183581259



223937 CESOIA SIEPI PROFESSIONALE TELESCOPICA PROFESSIONAL TELESCOPIC HEDGE SHEAR

- ♦ Lama in acciaio al carbonio ricoperta in teflon antiruggine
Carbon steel blade covered with anti-rust Teflon
- ♦ Manici telescopici in alluminio a sezione ovale con impugnatura ergonomica in gomma morbida antiscivolo e leva di blocco
Telescopic aluminum handles with oval section with grip Ergonomic soft non-slip rubber and locking lever
- ♦ Perno regolabile
Adjustable pin
- ♦ Ammortizzatori in gomma per un miglior assorbimento del taglio
Rubber shock absorbers for a better cut absorption

Codice	mm		Barcode
223937	da 660 a 860	3	8033116545235



223938 CESOIA SIEPI LAME ONDULATE HEDGE SHEAR CORRUGATED BLADES

- ♦ Lama superiore ondulata in acciaio al carbonio ricoperta in Teflon antiruggine
Corrugated upper blade in carbon steel covered with Teflon antirust
- ♦ Manici in alluminio con impugnatura ergonomica in gomma antiscivolo
Aluminum handles with ergonomic rubber grip non-slip
- ♦ Perno regolabile
Adjustable pin
- ♦ Ammortizzatori in gomma per un miglior assorbimento del taglio
Rubber shock absorbers for one a better absorption

Codice	mm		Barcode
223938	550	3	8033116545259



CREA IL TUO SPAZIO VERDE

CREATE YOUR GREEN SPACE



LINEA PRO
PRO LINE



PER ERBA
FOR GRASS



STERPAGLIA
STERPAGLIA



PER MARCIAPIEDI
FOR SIDEWALKS



PER PICCOLI ARBUSTI
FOR SMALL SHRUBS

352 Accessori per il terreno
Ground accessories

357 Fili per orti e giardini
Threads for vegetable gardens and gardens

359 Lame per ricambi
Spare parts blades

Accessori per orto e giardino

Garden accessories and garden

660070 TRAPIANTATORE IN ACCIAIO STEEL TRANSPLANTER

- ♦ Lama larga in acciaio
Wide steel blade
- ♦ Manico in termoplastica + polipropilene con foro sul manico per appenderlo
Thermoplastic + polypropylene handle with hanging hole on the handle

Codice	mm	gr		Barcode
660070	340 x 80	269	6	8033183585585



660071 RASTRELLO IN ACCIAIO STEEL RAKE

- ♦ 5 rebbi resistenti in acciaio con punta arrotondata
5 strong prongs with rounded tip
- ♦ Manico in termoplastica + polipropilene con foro sul manico per appenderlo
Thermoplastic + polypropylene handle with hanging hole on the handle

Codice	mm	gr		Barcode
660071	300 x 170	216	6	8033183585592



660072 ZAPPETTA IN ACCIAIO STEEL HOE

- ♦ Punta quadra in acciaio e punta tridente con rebbi resistenti
Square point and trident point with resistant steel prongs
- ♦ Manico in termoplastica + polipropilene con foro sul manico per appenderlo
Thermoplastic + polypropylene handle with hanging hole on the handle

Codice	mm	gr		Barcode
660072	300 x 180	288	6	8033183585608



660074 ZAPPETTA PUNTA A CUORE IN ACCIAIO
HEART-POINTED HOE IN STEEL

- ♦ Punta a cuore in acciaio e punta bidente con rebbi resistenti
Square point and trident point with resistant steel prongs
- ♦ Manico in termoplastica + polipropilene con foro sul manico per appenderlo
Thermoplastic + polypropylene handle with hanging hole on the handle

Codice	mm		Barcode
660074	290 x 190	6	8033183592002



660068 RASTRELLO A 9 DENTI IN ACCIAIO
9 TEETH STEEL RAKE

- ♦ 9 denti in acciaio a sezione piatta
Square point and trident point with resistant steel prongs
- ♦ Manico in termoplastica + polipropilene con foro sul manico per appenderlo
Thermoplastic + polypropylene handle with hanging hole on the handle

Codice	mm		Barcode
660068	390 x 160	6	8033183832986



660040 TRAPIANTATORE ECONOMICO
ECONOMIC PLASTIC TRANSPLANTER

- ♦ Corpo in termoplastica rinforzata + fibra di vetro, leggera e resistente
Body in reinforced thermoplastic + glass fiber, light and resistant
- ♦ Lama larga centimetrata a punta arrotondata
Wide centimeter blade with rounded tip
- ♦ Foro sul manico per appenderlo
Hole for hanging on the handle

Codice	mm	gr		Barcode
660040	280 x 80	96	6	8033183575845



660041 SARCHIELLO ECONOMICO
ECONOMIC PLASTIC SARCHIELLO

- ♦ Corpo in termoplastica rinforzata + fibra di vetro, leggera e resistente
Body in reinforced thermoplastic + glass fiber, light and resistant
- ♦ 3 rebbi resistenti con punta arrotondata
3 strong prongs with rounded tip
- ♦ Foro sul manico per appenderlo
Hole for hanging on the handle

Codice	mm	gr		Barcode
660041	280 x 100	89	6	8033183575852



660042 ZAPPETTA ECONOMICA
ECONOMIC PLASTIC HOE

- ♦ Corpo in termoplastica rinforzata + fibra di vetro, leggera e resistente
Body in reinforced thermoplastic + glass fiber, light and resistant
- ♦ Punta quadra e punta tridente con rebbi resistenti a punta tonda
Square point and trident point with resistant round point prongs
- ♦ Foro sul manico per appenderlo
Hole for hanging on the handle

Codice	mm	gr		Barcode
660042	320 x 100	168	6	803318575869

660040E TRAPIANTATORE
TRANSPLANTER

- ♦ Corpo in termoplastica rinforzata + fibra di vetro, leggera e resistente
Body in reinforced thermoplastic + glass fiber, light and resistant
- ♦ Lama a goccia
Drop blade
- ♦ Foro sul manico per appenderlo
Hole for hanging on the handle

Codice	mm	gr		Barcode
660040E	280 x 80	96	6	8033183575845

660041E SARCHIELLO
SARCHIELLO

- ♦ Corpo in termoplastica rinforzata + fibra di vetro, leggera e resistente
Body in reinforced thermoplastic + glass fiber, light and resistant
- ♦ 3 rebbi resistenti con punta arrotondata
3 strong prongs with rounded tip
- ♦ Foro sul manico per appenderlo
Hole for hanging on the handle

Codice	mm	gr		Barcode
660041E	280 x 100	89	6	8033183575852

660042E ZAPPETTA
HOE

- ♦ Corpo in termoplastica rinforzata + fibra di vetro, leggera e resistente
Body in reinforced thermoplastic + glass fiber, light and resistant
- ♦ Punta quadra e punta tridente con rebbi resistenti a punta tonda
Square point and trident point with resistant round point prongs
- ♦ Foro sul manico per appenderlo
Hole for hanging on the handle

Codice	mm	gr		Barcode
660042E	320 x 100	168	6	803318575869

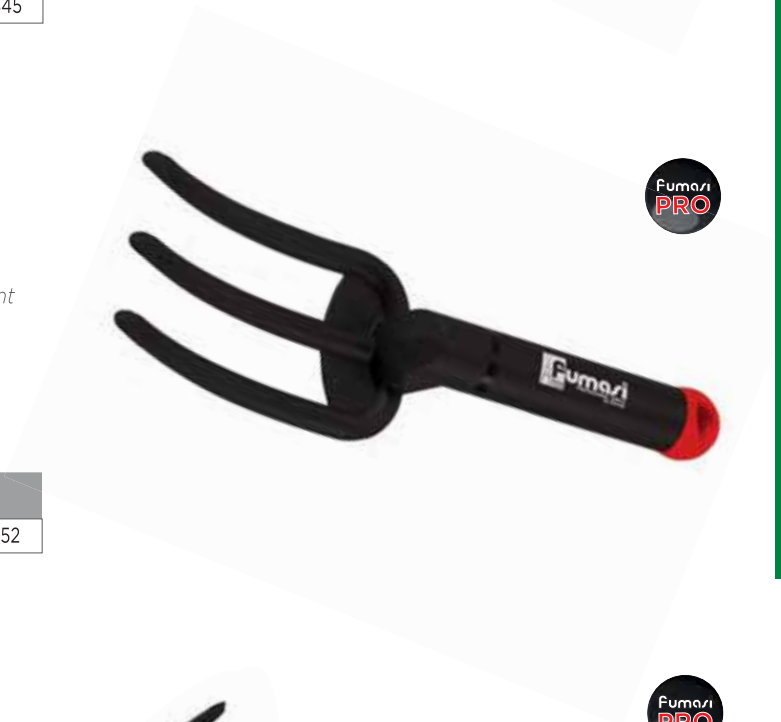

660069 TRAPIANTATORE IN ACCIAIO
STEEL TRANSPLANTER

- ♦ Lama larga centimetrata in acciaio
Square point and trident point with resistant round point prongs
- ♦ Foro sul manico per appenderlo
Hole for hanging on the handle

Codice	mm		Barcode
660069	290 x 80	6	8033183832979



660067 PELLOTTA DA GIARDINO
GARDEN PELLOTTA

- ♦ Pellotta in termoplastica rinforzata + fibra di vetro
Reinforced thermoplastic + glass fiber
- ♦ Foro sul manico per appenderlo
Hole for hanging on the handle

Codice	mm		Barcode
660067	340 x 120	6	8033183833020



660043 FORATERRA IN FERRO
IRON DRILL

Codice	mm		Barcode
660043	280	10	8033183576910



660044 PIANTABULBI IN FERRO
IRON BULBS

- ♦ Corpo in ferro con denti di taglio sul bordo inferiore e scala graduata sul lato (da 5 a 10 cm)
Iron body with cutting teeth on the lower edge and graduated scale on the side from 5 to 10 cm
- ♦ Pratica impugnatura in plastica antiurto che ne consente l'apertura
Practical shockproof plastic handle that allows it to be opened

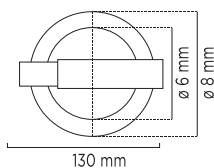

Codice	mm		Barcode
660044	230	10	8033183576927



670053 VISIERA CON PROTEZIONE FRONTALE
STEE

- ♦ Visiera ribaltabile e regolabile in policarbonato, rinforzato in alluminio lungo tutto il perimetro
Folding and adjustable visor in aluminum reinforced polycarbonate along the perimeter
- ♦ Calotta regolabile con rivestimento tergisudore in posizione frontale
Adjustable hood with sweat-wicking lining in front position

Codice	mm		Barcode
670053	200	3	8033183552921



609001P GUANTO IN PELLE FIORE BOVINA GLOVE IN COWHIDE GRAIN LEATHER

- ♦ Rivestimento in pelle fiore bovina sia sul dorso che sul palmo, avente capacità di estrema elasticità e resistenza
Cowhide grain leather lining both on the back and on the palm having the ability of extreme elasticity and resistance
- ♦ Palmo senza cuciture che rende il guanto più confortevole
Seamless palm that makes the glove more comfortable
- ♦ Polso orlato con elastico stringipolso interno
Cuffs edged with internal elastic cuffs

Codice	Taglia / Size		Barcode
609001P	10	10	8033183561886
609002P	9	10	8033183583642



609009 GUANTO IN LATTICE LATEX GLOVE

- ♦ Guanto a filo continuo calibro 13 poliestere/lattice con palmo ricoperto in schiuma di lattice
13 gauge seamless polyester / latex glove with palm covered in latex foam
- ♦ Finitura su palmo e dita zigrinate, per una miglior presa sia su superfici asciutte che umide
Finishing on palm and knurled fingers, for a better grip on both dry than humid surfaces
- ♦ Polso elasticizzato e dorso aerato
Elastic cuff and ventilated back

Codice	Taglia / Size		Barcode
609009	Per uomo / For men	9 - 10	10 8033183585684
60900D	Per donna / For women	7 - 8	10 8033183585691



470000 TELO PACCIAMATURA MULCHING CLOTH

- ♦ Rete agritela in polipropilene
Polypropylene agritela net
- ♦ Robusto, traspirante, assicura il passaggio dell'acqua
Sturdy, breathable, it ensures the passage of water

Codice	mt		Barcode
470000	1,5 x 10	1	8033183599261



47CP150 TUTORE IN PLASTICA RINFORZATO REINFORCED PLASTIC BRACE

- ♦ Canna rinforzata in PVC versatile, resistente e flessibile
Versatile, resistant and flexible PVC reinforced barrel
- ♦ Rinforzo interno a croce, nodi in rilievo su tutta la superficie sia per facilitare la legatura delle piante che per evitare che il legaccio scorra lungo la canna
Internal reinforcement cross knots in relief on the whole surface for both facilitate the tying of plants which to prevent the tie slide along the barrel

Codice	ø mm	mm		Barcode
47CO150	28	150	6	8033183838339
47CO210	28	210	6	8033183838346



47CPN12 TUTORE IN PLASTICA
PLASTIC BRACE

- ♦ Canna rinforzata in PVC versatile, resistente e flessibile
Versatile, resistant and flexible PVC reinforced barrel
- ♦ Interno cavo e nodi in rilievo su tutta la superficie sia per facilitare la legatura delle piante che per evitare che il legaccio scorra lungo la canna
Internal reinforcement cross knots in relief on the whole surface for both facilitate the tying of plants which to prevent the tie slide along the barrel



Codice	∅ mm	mm		Barcode
47CPN12	17	1200	6	8033183838322

660073 PIATTINA FILO PLASTIFICATO
PLASTIC-PLATED WIRE BAND

- ♦ Filo di ferro rivestito in PVC verde
Green PVC coated iron wire
- ♦ Fornito in erogatore con tagliafili
Supplied in dispenser with wire cutters



Codice	mt		Barcode
660073	50	12	8033183585615

660075 FILO PER RECINZIONI
WIRE FOR FENCES

- ♦ Filo in PVC plastificato verde
Green plasticized PVC wire



Codice	∅ mm	mt		Barcode
660075	1,6	16	6	8033183592064
660076	1,5	100	6	8033183592057

660077 ROTOLO RAFIA SINTETICA
ROLL SYNTHETIC RAFFIA

- ♦ Morbido, resistente e facilmente lavorabile
Soft, resistant and easily workable
- ♦ Colori assortiti
Assorted colors



Codice	mt		Barcode
660077 	200	5	8033183591609

660078 ROTOLO IN PVC
ROLL IN PVC

- ♦ Cordino in PVC plastificato
Lanyard in plasticized PVC
- ♦ Elevata resistenza alla trazione e alle intemperie
High resistance to traction and bad weather



Codice	∅ mm		Barcode
660078	3	5	8033183592040

660079 FILO DECESPUGLIATORE TONDO ROUND BRUSHCUTTER WIRE

- ♦ Filo in nylon
Nylon thread
- ♦ Elevata durata di taglio
Long cutting life

Codice	ø mm	mt	Applicazioni / Applications					Barcode		
			Erba Grass	Sterpaglia Brushwood	Arbusti Shrubs	Sottobosco Undergrowth	Marcialedi Pavements			
660079	1,6	15	●					12	8033183591494	
660080	2,0	15	●					12	8033183590701	
660081	2,4	15	●					12	8033183590718	
660082	3,0	15	●	●	●		●	12	8033183590725	
660085	Tipo EXTRA / EXTRA type	2,4	87	●				5	8033183590763	
660086	Tipo EXTRA / EXTRA type	3,0	56	●	●	●		●	5	8033183590770



660083 FILO DECESPUGLIATORE QUADRO SQUARE BRUSHCUTTER WIRE

- ♦ Filo in nylon
Nylon thread
- ♦ Elevata durata di taglio
Long cutting life

Codice	ø mm	mt	Applicazioni / Applications					Barcode		
			Erba Grass	Sterpaglia Brushwood	Arbusti Shrubs	Sottobosco Undergrowth	Marcialedi Pavements			
660083	2,4	15	●	●				12	8033183590749	
660084	3,0	15	●	●	●		●	12	8033183590756	
660087	Tipo EXTRA / EXTRA type	2,4	69	●	●			5	8033183590787	
660088	Tipo EXTRA / EXTRA type	3,0	44	●	●	●		●	5	8033183590794



660089 FILO DECESPUGLIATORE QUADRO SEGHETTATO SERRATED SQUARE BRUSHCUTTER WIRE









- ♦ Filo in nylon
Nylon thread
- ♦ Elevata durata di taglio
Long cutting life

Codice	ø mm	mt	Applicazioni / Applications					Barcode	
			Erba Grass	Sterpaglia Brushwood	Arbusti Shrubs	Sottobosco Undergrowth	Marcialedi Pavements		
660089	3,0	44	●	●	●			5	8033183590800



Lame per ricambi

Garden accessories and garden

Codice / Code			Barcode
RICAMBI PER SVETTATOI / SPARE PARTS FOR BRAKES	660033LM Per / To • 660033 	KIT LAMA + MOLLA BLADE + SPRING KIT Lama in Teflon / Teflon blade (mm): 140 x 80 Molla in acciaio / Steel spring (mm): 60 x 0,8	1 8033183580795
	660033SE Per / To • 660033 	KIT LAMA + MOLLA + FETTUCCIA + CAVO IN ACCIAIO KIT BLADE + SPRING + STRAP + STEEL CABLE Lama in Teflon / Teflon blade (mm): 140 x 80 Molla in acciaio / Steel spring (mm): 60 x 0,8 Fettuccia / Tape (mm): 1100 x 0,8 Cavetto in acciaio / Steel cable (mm): 720	1 8033183841117
	660033F Per / To • 660033 • 660032 	FETTUCCIA TAPE Dimensioni / Dimensions (mm): 1100 x 0,8	1 8033183592569
	660033FA Per / To • 660033 	CAVETTO IN ACCIAIO STEEL CABLE Dimensioni / Dimensions (mm): 720	1 8033183592620
	660032L Per / To • 660032 	LAMA DI RICAMBIO IN TEFLON TEFLON REPLACEMENT BLADE Dimensioni / Dimensions (mm): 120 x 90	1 8033183835949
RICAMBI PER TRONCARAMI / SPARE PARTS FOR LOPPERS	223931L Per / To • 223931 	LAMA DI RICAMBIO IN TEFLON TEFLON REPLACEMENT BLADE Dimensioni / Dimensions (mm): 170 x 33	1 8033183598875
	223934L Per / To • 223934 	LAMA DI RICAMBIO IN TEFLON TEFLON REPLACEMENT BLADE Dimensioni / Dimensions (mm): 170 x 33	1 803318355526
	223935L Per / To • 223935 	LAMA DI RICAMBIO IN TEFLON TEFLON REPLACEMENT BLADE Dimensioni / Dimensions (mm): 165 x 28	1 8033183846723

Codice / Code			Barcode
231881 Per / To • 230881		LAMA DI RICAMBIO IN ACCIAIO TEFL Dimensioni / Dimensions (mm): 155 x 33	1 8033183574862
223323 Per / To • 223322		LAMA DI RICAMBIO IN ACCIAIO SPARE STEEL BLADE Dimensioni / Dimensions (mm): 117 x 12	1 8033183576736
231862 Per / To • 230862		LAMA DI RICAMBIO IN ACCIAIO SPARE STEEL BLADE Dimensioni / Dimensions (mm): 83 x 25	1 8033183574855
231876 Per / To • 230876		LAMA DI RICAMBIO IN ACCIAIO SPARE STEEL BLADE Dimensioni / Dimensions (mm): 105 x 25	1 8033183574879
231877 Per / To • 230877		LAMA DI RICAMBIO IN ACCIAIO SPARE STEEL BLADE Dimensioni / Dimensions (mm): 90 x 42	1 8033183574886
231878 Per / To • 230878		LAMA DI RICAMBIO IN ACCIAIO SPARE STEEL BLADE Dimensioni / Dimensions (mm): X	1 8033183574831
231879 Per / To • 230879		LAMA DI RICAMBIO IN ACCIAIO SPARE STEEL BLADE Dimensioni / Dimensions (mm): 100 x 20	1 8033183574848
231880 Per / To • 230880 • 223718 • 223721 • 223723		KIT 2 MOLLE IN ACCIAIO 2 STEEL SPRINGS KIT Dimensioni / Dimensions (mm): 60	1 8033183591470
231875 Per / To • 230876 • 230077 • 230078 • 230079		KIT 2 MOLLE IN ACCIAIO 2 STEEL SPRINGS KIT Dimensioni / Dimensions (mm): 60	1 8033183576774

RICAMBI PER FORBICI DA POTATURA /
SPARE PARTS FOR PRUNING SCISSORS

A SERVIZIO DELLA SARTORIA PROFESSIONALE E NON

AT THE SERVICE OF PROFESSIONAL AND
NON-PROFESSIONAL TAILORING

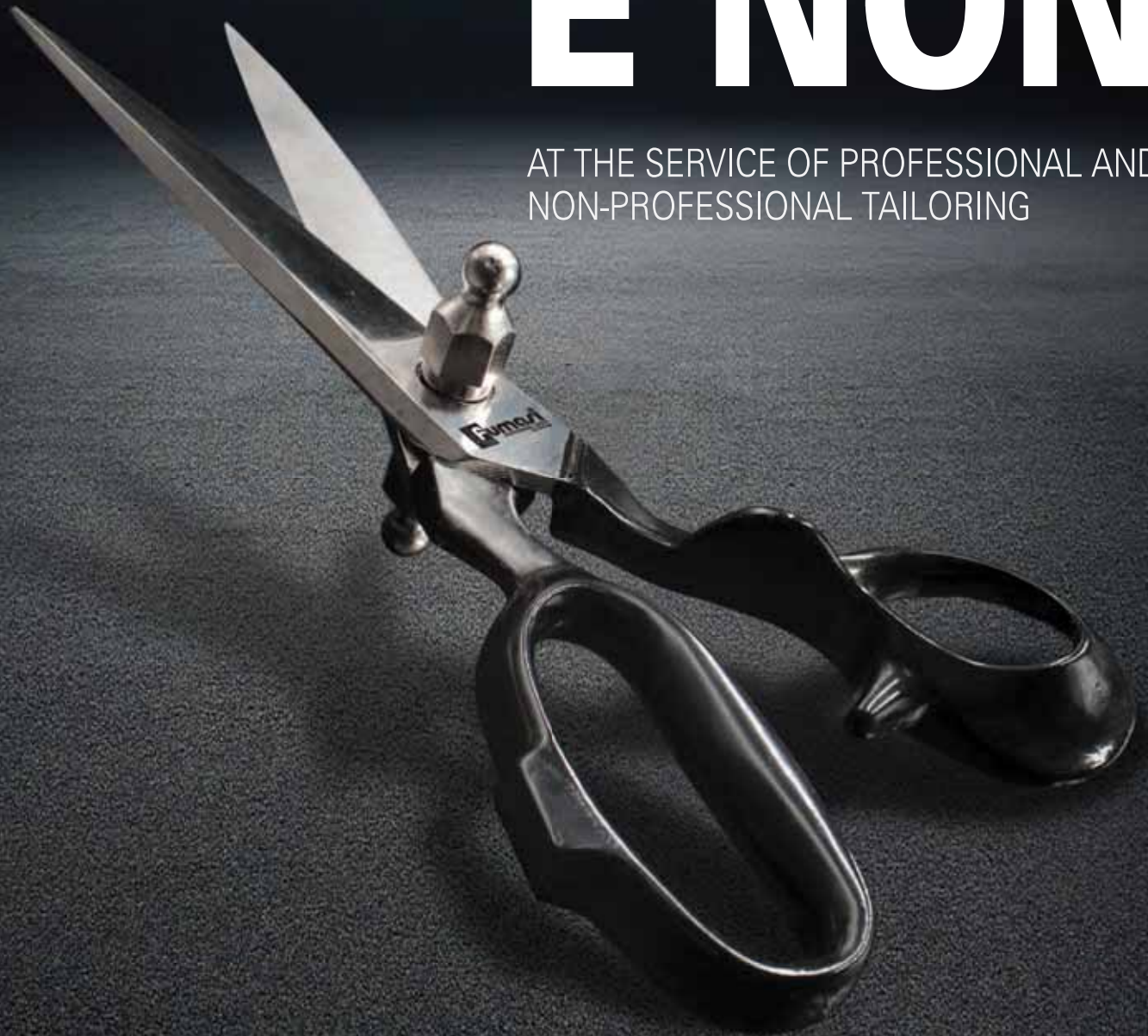

LINEA PRO
PRO LINE

364 Merceria
Haberdashery

374 Frobici taglio KEVLAR
KEVLAR cutting scissors

Forbici multiuso

Multi-purpose scissors

223240 FORBICI DA LAVORO TIPO FRANCESE FRENCH TYPE WORK SCISSORS

- Interamente in acciaio al carbonio C50 rivestito in nickel
Entirely in C50 carbon steel coated with nickel
- Lame con durezza di 52/56 HRC, rifinite con macchine di estrema precisione
Blades with hardness of 52/56 HRC, finished with machines of extreme precision

Codice	mm	gr	📦	Barcode
223240	105	36	12	8033116544498
223245	115	48	12	8033116544504
223250	125	60	12	8033116544511
223255	140	65	12	8033116544528



Codice	mm	gr	📦	Barcode
223260	155	79	12	8033116544535
223265	165	88	12	8033116544542
223270	180	110	12	8033116544559
223280	205	135	12	8033116544566

223250C FORBICI DA LAVORO CURVE CURVE WORKING SCISSORS

- Interamente in acciaio al carbonio C50 rivestito in nickel
Entirely in C50 carbon steel coated with nickel
- 2 punte ad andamento curvo
2 curved tips

Codice	mm	gr	📦	Barcode
223250C	125	58	12	8033183567239
223260C	155	73	12	80331835672



223140 FORBICI MERCANTE TIPO FRANCESE MERCHANT SCISSORS FRENCH TYPE

- Interamente in acciaio al carbonio C50 rivestito in nickel
Entirely in C50 carbon steel coated with nickel
- Punta arrotondate e lame con durezza di 52/56 HRC, rifinite con macchine di estrema precisione
Rounded tips and blades with hardness of 52/56 HRC, finished with machines of extreme precision

Codice	mm	gr	📦	Barcode
223140	105	35	12	8033116545587
223150	125	59	12	8033116545600
223160	155	73	12	8033116545624



223560 FORBICI SARTINA TAILORING SCISSORS



- Interamente in acciaio al carbonio C50 rivestito in nickel
Entirely in C50 carbon steel coated with nickel
- Lame con durezza di 52/56 HRC, rifinite con macchine di estrema precisione
Blade with hardness of 52/56 HRC, finished with machines of extreme precision
- Manici ad anelli asimmetrici per un massimo comfort
Asymmetrical ring handle for maximum comfort



Codice	mm	gr		Barcode
223560	155	120	12	8033116544610
223570	180	150	12	8033116544634
223580	205	170	12	8033116544658

223307 FORBICI DA UFFICIO OFFICE SCISSORS



- Interamente in acciaio al carbonio C50 rivestito in nickel
Entirely in C50 carbon steel coated with nickel
- Lame lunghe, rifinite con macchine di estrema precisione
Blades with hardness of 52/56 HRC, finished with machines of extreme precision
- Manico ad anelli simmetrici
Symmetrical ring handle



Codice	mm	gr		Barcode
223307	180	95	12	8033116545631
223308	205	105	12	8033116545648
223309	230	115	12	8033116545655
223310	255	130	12	8033116545662

223824 FORBICI PIEGHEVOLI FOLDING SCISSORS

- Lame richiudibili in acciaio al carbonio con finitura teflonata
Resealable blades in carbon steel with Teflon finish
- Manici in plastica in colori assortiti
Plastic handles in assorted colors



Codice	mm	gr		Barcode	
223824	110	19	12	8033116545716	
223825	Con portachiavi / With key ring	110	19	12	8033116545723

226640 FORBICI PER SCUOLA SCHOOL SCISSORS

- Punta arrotondate e lame centimetrata in acciaio INOX
Rounded tips and centimeter blades in stainless steel
- Manici in plastica in colori assortiti
Plastic handles in assorted colors



Codice	Pezzi / Pieces	mm	gr		Barcode
226640		110	13	12	8033116545693
226650		125	23	12	8033116545709
226641	24	Espositore / Exhibitor 12 x 226640 - 50		1	8033183552907

233485S FORBICI MULTIUSO IN ACCIAIO INOX MULTIPURPOSE SCISSORS IN STAINLESS STEEL

- Lame microdentate in acciaio INOX
Micro-toothed stainless steel blades
- Manici in ABS rossi, pratici e maneggevoli
Red ABS handles, practical and easy to handle

Codice	mm	gr	📦	Barcode
233485S	215	98	12	8033116545518



233255T FORBICI MULTIUSO IN TITANIO MULTIPURPOSE SCISSORS TITANIUM COATED

- Lame microdentate in acciaio INOX temperato rivestite al titanio che ne garantisce un'estrema robustezza
Micro-toothed blades in tempered stainless steel coated with titanium that guarantees extreme strength
- Durezza lame 54 HRC
Hardness of blades 54 HRC
- Lame antiruggine e lavabili in lavastoviglie
Rustproof and dishwasher safe blades
- Manici in bimatereale con rivestimento in gomma delle parti soggette ad usura, garantisce un elevato comfort nell'utilizzo prolungato
Bi-material handles with rubber coating on the subject parts wear that guarantees high comfort in prolonged use
- Manici ad anelli asimmetrici (nelle misure grandi) per meglio guidare il taglio e rendere agevole il lavoro anche agli operatori mancini
Asymmetrical ring handles (in large sizes) for better guidance cutting and make work easier even for left-handed operators

Codice	Pezzi / Pieces	mm	gr	📦	Barcode
233255T		135	36	12	8033183552563
233265T		165	43	12	8033183552549
233480T		210	106	12	8033183553454
233490T		230	110	12	8033183552570
234380T	24	Espositore / Exhibitor 6 x 233255T - 65T; 6 x 233480T - 90T		1	8033183554055



233255B FORBICI MULTIUSO IN ACCIAIO INOX MULTIPURPOSE SCISSORS IN STAINLESS STEEL

- Lame microdentate in acciaio INOX
Micro-toothed stainless steel blades
- Manici in bimatereale bicolore con rivestimento in gomma delle parti soggette ad usura, garantisce un elevato comfort nell'utilizzo prolungato
Two-tone bi-material handles with rubber coating of the parts subject to wear which guarantees a high level of comfort in use prolonged
- Manici ad anelli asimmetrici (nelle misure grandi) per meglio guidare il taglio e rendere agevole il lavoro anche agli operatori mancini
Asymmetrical ring handles (in large sizes) for better guidance cutting and make work easier even for left-handed operators

Codice	Pezzi / Pieces	mm	gr	📦	Barcode
233255B		140	32	12	8033183552419
233265B		165	41	12	8033183552457
233475B		190	60	12	8033116540940
233485B		215	90	12	8033116540957
233495B		240	120	12	8033116540964
234375B	24	Espositore / Exhibitor 6 x 233255B - 65B; 6 x 233475B - 85B		1	8033183553706



223710 FORBICI MULTIUSO PROFESSIONALI PROFESSIONAL MULTIPURPOSE SCISSORS



- Lame in acciaio inossidabile AISI 420 temperato ad atmosfera con durezza 50/54 HRC
Atmosphere tempered AISI 420 stainless steel blades with hardness 50/54 HRC
- Manici ergonomici in nylon ultraleggeri con anelli asimmetrici (nelle misure grandi) per meglio guidare il taglio
Ergonomic handles in ultralight nylon with asymmetrical rings (in large sizes) to better guide the cut
- Sistema di fissaggio a vite con controdado
Screw fixing system with lock nut



Codice	mm	gr		Barcode
223710	155	46	6	8033183553416
223711	190	67	6	8033183552471
223712	210	85	6	8033183552297

Codice	mm	gr		Barcode
223713	240	130	6	8033183552488
223714	260	138	6	8033183560667

233255TB FORBICI MULTIUSO IN TITANIO BRONZE MULTIPURPOSE SCISSORS BRONZE TITANIUM COATED



- Lame microdentate (54HRC) in acciaio INOX temperato rivestite al titanio BRONZE antiruggine, garantisce un'estrema robustezza
Micro-toothed blades in tempered stainless steel coated with titanium BRONZE which guarantees extreme robustness
- Manici in bimatereale con rivestimento in gomma delle parti soggette ad usura che garantisce un elevato comfort nell'utilizzo prolungato
Bi-material handles with rubber coating on the subject parts wear that guarantees high comfort in prolonged use
- Manici ad anelli asimmetrici (nelle misure grandi)
Asymmetrical ring handles (in large sizes)

Codice	mm		Barcode
233255TB	135	12	8033183843197
233265TB	165	12	8033183843203
233480TB	210	12	8033183843210
233490TB	230	12	8033183843227



233255TNS FORBICI MULTIUSO IN TITANIO NO STICK MULTIPURPOSE SCISSORS NO STICK TITANIUM COATED



- Lame microdentate (54HRC) in acciaio INOX temperato rivestite al titanio NO STICK antiruggine, permette di tagliare fogli rivestiti di colla senza che ne rimanga nessun residuo tra le lame
Micro-toothed blades in tempered stainless steel coated with titanium NO STICK that allows you to cut sheets coated with glue without that no residue remains between the blades
- Manici in bimatereale con rivestimento in gomma delle parti soggette ad usura che garantisce un elevato comfort nell'utilizzo prolungato
Bi-material handles with rubber coating on the subject parts wear that guarantees high comfort in prolonged use
- Manici ad anelli asimmetrici (nelle misure grandi)
Asymmetrical ring handles (in large sizes)

Codice	mm		Barcode
233255TNS	135	12	8033183843432
233265TNS	165	12	8033183843449
233480TNS	210	12	8033183843456
233490TNS	230	12	8033183843463



Forbici per l'industria tessile

Scissors for the textile industry

- 1** Modelli progettati per forme e materiali ad usi specifici per settori specifici.
Models designed for shapes and materials for specific uses for specific sectors.
- 2** Realizzate con i migliori acciai al carbonio C50 rivestito in nichel che ne garantisce elevati standard qualitativi in termini di precisione, capacità di taglio e durata del filo.
Made with the best carbon steels C50 nickel coated and guarantees it high quality standards in terms of precision, cutting capacity and durability of the thread.
- 3** Lame con durezza 52/56 HRC.
Blades with hardness 52/56 HRC.

3607NV07 FORBICI PER SARTO TAILOR SCISSORS

- ♦ Lame in acciaio al carbonio C50 rivestite in nickel con durezza di 52/56 HRC temperate a sale
C50 carbon steel blades coated with nickel with hardness of 52/56 HRC tempered with salt
- ♦ Manici ergonomici con verniciatura ad immersione color nero con anelli asimmetrici per meglio guidare il taglio
Ergonomic handles with black immersion paint with asymmetrical rings to better guide the cut

Codice	mm	gr		Barcode
3607NV07	180	160	6	8033116544849
3607NV08	205	220	6	8033116544856
3607NV09	230	250	6	8033116544863



Codice	mm	gr		Barcode
3607NV10	255	300	6	8033116544870
3607NV11	280	500	6	8033116544887
3607NV12	380	550	6	8033116544894

340606V FORBICI PER SARTO WISS WISS TAILOR SCISSORS

- ♦ Lame in acciaio al carbonio C50 rivestite in nickel con durezza di 52/56 HRC temperate a sale
C50 carbon steel blades coated with nickel with hardness of 52/56 HRC tempered with salt
- ♦ Manici ergonomici con verniciatura ad immersione color nero con anelli asimmetrici per meglio guidare il taglio
Ergonomic handles with black immersion paint with asymmetrical rings to better guide the cut

Codice	Pollici / Inches	mm	gr		Barcode
340606V	6	150	140	12	8033116545020
340607V	7	180	160	12	8033116545037
340608V	8	205	185	12	8033116545044
340609V	9	230	205	12	8033116545051



860606V FORBICI PER SARTO WISS WISS TAILOR SCISSORS

- Interamente in acciaio al carbonio C50 rivestite in nickel con durezza di 52/56 HRC temperate a sale
Entirely in carbon steel C50 coated with nickel with hardness of 52/56 HRC tempered with salt
- Manici ergonomici con anelli asimmetrici per meglio guidare il taglio
Ergonomic handles with asymmetrical rings to better guide the cut

Codice	Pollici / Inches	mm	gr		Barcode
860606V	6	150	130	6	8033183846969
860608V	8	205	180	6	8033183846976
860609V	9	230	235	6	8033183846983



863610V FORBICI SARTO PESANTE CUTTING SCISSORS

- Vite pivot
Pivot screw
- Manici ergonomici con verniciatura ad immersione color nero con anelli asimmetrici per meglio guidare il taglio
Ergonomic handles with black immersion paint with asymmetrical rings to better guide the cut

Codice	Pollici / Inches	mm	gr		Barcode
863610V	10	255	400	6	8033183846990



860610G FORBICI MODELLO GIAPPONESE JAPANESE PATTERN SCISSORS

- Interamente in acciaio al carbonio C50 rivestito in nickel
Entirely in C50 carbon steel coated with nickel
- Vite "Stay Set"
"Stay Set" screw
- Manici ergonomici con anelli asimmetrici per meglio guidare il taglio
Ergonomic handles with asymmetrical rings to better guide the cut

Codice	Pollici / Inches	mm	gr		Barcode
860610G	10	255	250	6	8033183847034



863208M FORBICI MODELLO MARTEAUX SCISSORS MARTEAUX MODEL

- Interamente in acciaio al carbonio C50 rivestito in nickel
Entirely in C50 carbon steel coated with nickel
- Progettata per lavori di forza
Design for strength work
- Dado e bullone regolabili
Adjustable nut and bolts

Codice	Pollici / Inches	mm	gr		Barcode
863208M	8	205	156	6	8033183847003
863209M	9	230	200	6	8033183847010
863210M	10	255	247	6	8033183847027



863206 FORBICI MODELLO BANCAL SCISSORS BANCAL MODEL

- Interamente in acciaio al carbonio C50 rivestito in nickel
Entirely in C50 carbon steel coated with nickel
- Progettata per lavori di forza
Design for strength work

Codice	Pollici / Inches	mm	gr		Barcode
863206	6,5	165	103	6	8033183847041
863207	7	180	115	6	8033183847058
863208	8	205	125	6	8033183847065



863408 FORBICI INDUSTRIALI RETTE STRAIGHT INDUSTRIAL SCISSORS

- Interamente in acciaio al carbonio C50 rivestito in nickel
Entirely in C50 carbon steel coated with nickel
- Manici ergonomici con anelli asimmetrici per meglio guidare il taglio
Ergonomic handles with asymmetrical rings to better guide the cut

Codice	Pollici / Inches	mm	gr		Barcode
863408	8	205	190	12	8033183847072



863408V FORBICI INDUSTRIALI CURVE CURVED INDUSTRIAL SCISSORS

- Manici ad andamento curvo
Curved handles
- Manici ergonomici con verniciatura ad immersione color nero con anelli asimmetrici per meglio guidare il taglio
Ergonomic handles with black immersion paint with asymmetrical rings to better guide the cut

Codice	Pollici / Inches	mm	gr		Barcode
863408V	8	205	202	12	8033183847089



870711 FORBICI DA TAGLIATORE CUTTING SCISSORS

- Doppio bullone prolungato
Extended double bolt
- Manici ergonomici con verniciatura ad immersione color nero con anelli asimmetrici per meglio guidare il taglio
Ergonomic handles with black immersion paint with asymmetrical rings to better guide the cut

Codice	Pollici / Inches	mm	gr		Barcode
870711	11	280	540	6	8033183846921
870712	12	305	555	6	8033183846938
870713	13	330	665	6	8033183846945
870714	14	355	900	6	8033183846952



870611 FORBICI DA TAGLIATORE CUTTING SCISSORS

- ♦ Interamente in acciaio al carbonio C50 rivestito in nickel
Entirely in C50 carbon steel coated with nickel
- ♦ Doppio bullone prolungato
Extended double bolt
- ♦ Manici ergonomici con anelli asimmetrici per meglio guidare il taglio
Chrome plating treatment available on request

Codice	Pollici / Inches	mm	gr		Barcode
870611	11	280	540	6	8033183846853
870612	12	305	555	6	8033183846860
870613	13	330	665	6	8033183846877
870614	14	355	900	6	8033183846884



230870 FORBICI PER CUOIO SCISSORS FOR LEATHER

- ♦ Lame in acciaio al carbonio C50 con testa lucida
C50 carbon steel blades with polished head
- ♦ Manici ergonomici con verniciatura ad immersione color nero
Ergonomic handles with black immersion paint

Codice	mm	gr		Barcode
230870	230	347	12	8033116544665



233175 FORBICI PER CUOIO SCISSORS FOR LEATHER

- ♦ Lame micronentate in acciaio al carbonio C50 con testa lucida
Micronentate blades in C50 carbon steel with polished head
- ♦ Manici ergonomici con verniciatura ad immersione color nero
Ergonomic handles with black immersion paint

Codice	Pollici / Inches	mm	gr		Barcode
233175	8	210	310	12	8033116544672
233110	10	255	330	12	8033116544689



2332126 FORBICI PER CUOIO SCISSORS FOR LEATHER

- ♦ Interamente in acciaio al carbonio C50 rivestito in nickel
Entirely in C50 carbon steel coated with nickel
- ♦ Lame microdentate
Micro-toothed blades

Codice	Pollici / Inches	mm	gr		Barcode
2332216	6	150	130	12	8033183846891
2332127	7	180	150	12	8033183846907



223820 FORBICI TAGLIACAMPIONI IN GHISA CAST IRON SAMPLE CUTTER SCISSORS

- Lame a Zig-Zag in ghisa, ottime per non fare sfilare i tessuti
Cast iron Zig-Zag blades, excellent for not letting the fabrics slip off
- Manici in nylon ad anelli asimmetrici
Nylon handles with asymmetrical rings

Codice	mm	gr		Barcode
223820	205	177	12	8033116544962



233308 FORBICI TAGLIACAMPIONI IN ACCIAIO STEEL SAMPLE CUTTING SCISSORS

- Lame a Zig-Zag in acciaio al carbonio forgiato, temprato e nichelato, con durezza 54-56 HRC
Zig-Zag blades in forged and hardened nickel-plated carbon steel with hardness 54-56 HRC
- Manici in nylon ad anelli asimmetrici
Nylon handles with asymmetrical rings

Codice	mm	gr		Barcode
233308	108	190	6	8033116544696
233309	205	215	6	8033116544702



223821 FORBICI TAGLIACAMPIONI IN ACCIAIO STEEL SAMPLE CUTTING SCISSORS

- Interamente in acciaio al carbonio C50 rivestito in nickel
Entirely in C50 carbon steel coated with nickel
- Lame a Zig-Zag in acciaio al carbonio forgiato, temprato e nichelato, con durezza 54-56 HRC
Zig-Zag blades in forged and hardened nickel-plated carbon steel with hardness 54-56 HRC
- Manici verniciati ad anelli asimmetrici
Painted handles with asymmetrical rings

Codice	mm	gr		Barcode
223821	205	260	6	8033116544979



223845 FORBICI TESSITORE WEAVING SCISSORS

- Lame in acciaio al carbonio C50 con finitura nichelata, dotate di sistema a molla per facilitarne l'uso
C50 carbon steel blades with nickel-plated finish equipped with spring system that facilitates its use
- Impugnatura monolaterale che permette di lavorare per lungo tempo senza affaticare le mani
Single-sided handle that allows you to work for a long time without tiring your hands

Codice		mm	gr		Barcode
223845	Lama retta / Straight blade	115	72	12	8033116544597
224145	Lama curva / Curved blade	115	72	12	8033116544573



233128 FORBICI PER TAPPEZZIERI
SCISSORS FOR UPHOLSTERY

- ♦ Punta molto sottile che permettono un taglio preciso anche nei punti più difficili
Very thin tips that allow a precise cut even in most difficult points
- ♦ Manici lunghi per facilitare il lavoro
Long handles for easier work

Codice		mm	gr		Barcode
233128	Manico retto / <i>Straight handle</i>	150	41	12	8033183847096
233129	Manico curvo / <i>Curved handle</i>	150	41	12	8033183847102



233130 FORBICI PER TAPPEZZIERI
SCISSORS FOR UPHOLSTERY

- ♦ Punta ad andamento curvo, molto sottili, che permettono un taglio preciso anche nei punti più difficili
Very thin curved tips that allow a cut precise even in the most difficult points
- ♦ Manici lunghi curvi per facilitare il lavoro
Long handles for easier work

Codice		mm	gr		Barcode
233130		150	45	12	8033183847119



233131 FORBICI PER TAPPEZZIERI A MEZZALUNA
SCISSORS FOR UPHOLSTERY HALF MOON

- ♦ Una lama a punta sottile ed una lama con speciale forma a mezzaluna per raccogliere i residui di tessuto
A thin-pointed blade and a special crescent-shaped blade to collect fabric residues
- ♦ Manici lunghi con anelli asimmetrici
Long handles with asymmetrical rings

Codice		mm	gr		Barcode
233131	Manico retto / <i>Straight handle</i>	180	55	12	8033183847126
233132	Manico curvo / <i>Curved handle</i>	180	55	12	8033183847133



233134 FORBICI PER TAPPEZZIERI A MEZZALUNA
SCISSORS FOR UPHOLSTERY HALF MOON

- ♦ Una lama a punta sottile ed una lama con speciale forma a mezzaluna per raccogliere i residui di tessuto
A thin-pointed blade and a special crescent-shaped blade to collect fabric residues
- ♦ Manici lunghi per facilitare il lavoro
Long handles for easier work

Codice		mm	gr		Barcode
233134	Manico retto / <i>Straight handle</i>	150	54	12	8033183847140
233135	Manico curvo / <i>Curved handle</i>	150	54	12	8033183847457



220707 AFFILALAME
SHARPENER

- Due mole preimpostate:
 - ▶ **Mola in carburo spesso:** per la sgrassatura e affilatura della lama
 - ▶ **Mola in ceramica:** per rifinire l'affilatura

Two preset wheels:

- ▶ **Thick carbide wheel:** for degreasing and sharpening the blade
 - ▶ **Ceramic wheel:** to finish the sharpening
- Impugnatura soft-grip antiscivolo
Soft-grip non-slip handle

Codice	mm		Barcode
220707	205 x 75	12	8033183598561

**Forbici taglio KEVLAR**
KEVLAR cutting scissors**223710K** FORBICI MULTIUSO PER KEVLAR
MULTIPURPOSE SCISSORS FOR KEVLAR

- Lame microdentate in acciaio INOX temperato con durezza 62 HRC
Micro-toothed blades in tempered stainless steel with hardness 62 HRC
- Manici ergonomici in nylon ultraleggeri con anelli asimmetrici (nelle misure grandi) per meglio guidare il taglio
Ergonomic handles in ultralight nylon with asymmetrical rings (in large sizes) to better guide the cut
- Vite in acciaio INOX 303
303 stainless steel screw

Codice	Pollici / Inches	mm	gr		Barcode
223710K	6	155	130	6	8033183847164
223713K	9,5	240	197	6	8033183847171
223714K	10,5	265	400	6	8033183846839

**3607NV10K** FORBICI SARTO PER KEVLAR
TAILOR SCISSORS FOR KEVLAR

- Lame microdentate in acciaio al carbonio con durezza 57/58 HRC
Micro-toothed blades in carbon steel with hardness 57/58 HRC
- Manici ergonomici in acciaio verniciato blu con anelli asimmetrici per meglio guidare il taglio
Ergonomic handles in blue painted steel with asymmetrical rings to better guide the cut
- Vite con sistema "pivot"
Screw with "pivot" system

Codice	Pollici / Inches	mm	gr		Barcode
3607NV10K	10	255	400	6	8033183846846



DESIGN INNOVATIVI PER LA CUCINA QUOTIDIANA

INNOVATIVE DESIGN FOR EVERYDAY KITCHEN



LINEA PRO
PRO LINE

376 Forbici da cucina
Kitchen scissors

Forbici cucina

Kitchen scissors

223822 FORBICI PER CUCINA PROFESSIONALE PROFESSIONAL KITCHEN SCISSORS

- ◆ Lame microdentate in acciaio di altissima qualità, finitura lucida ed ottima capacità di taglio
Micro-toothed blades in very high quality steel with a glossy finish with excellent cutting capacity
- ◆ Lame smontabili con un semplice gesto per una pulizia perfetta
Removable blades with a simple gesture for perfect cleaning
- ◆ Manici robusti ed ergonomici in acciaio verniciato nero con apribottiglie integrato
Sturdy and ergonomic handles in black painted steel with integrated bottle opener

Codice		mm	gr		Barcode
223822	Lama cromata / Chromed blade	215	170	12	8033116540933
2238221	Lama INOX / Stainless steel blade	215	165	6	8033183553805



223719 FORBICI PER CUCINA PROFESSIONALE PROFESSIONAL KITCHEN SCISSORS

- ◆ Lame microdentate in acciaio INOX AISI 420 di altissima qualità con ottima capacità di taglio
Micro-toothed blades in AISI 420 stainless steel of the highest quality with excellent cutting capacity
- ◆ Lame smontabili con un semplice gesto per una pulizia perfetta
Removable blades with a simple gesture for perfect cleaning
- ◆ Manici robusti ed ergonomici in nylon antiscivolo con apribottiglie integrato
Sturdy and ergonomic handles in non-slip nylon with bottle opener integrated

Codice		mm	gr		Barcode
223719		220	115	12	8033116545341



223819 FORBICI PER CUCINA KITCHEN SCISSORS

- ◆ Lame microdentate in acciaio INOX
Micro-toothed stainless steel blades
- ◆ Impugnatura in plastica con apribottiglie integrato
Plastic handle with integrated bottle opener

Codice		mm	gr		Barcode
223819		115	114	12	8033183551924



223924 TRINCIAPOLLO TIPO RETTO STRAIGHT POILTRY SHEAR

- ♦ Lame finemente seghettate in acciaio INOX di altissima qualità con finitura a specchio, regolabili tramite vite
Finely serrated blades made of very high quality stainless steel with mirror finish, adjustable screw
- ♦ Manici in acciaio inox anti-scivolo con zigrinatura interna ed esterna
Non-slip stainless steel handles with internal and external knurling
- ♦ Meccanismo a molla per un utilizzo senza sforzo
Spring mechanism for effortless use
- ♦ Sistema di blocco delle lame
Blade locking system

Codice		mm	gr		Barcode
223924	Lama cromata / <i>Chromed blade</i>	240	273	6	8033116545426
223924I	Lama INOX / <i>Stainless steel blade</i>	240	269	6	8033116545433



223901 TRINCIAPOLLO TIPO GAZZELLA GAZZELLA POILTRY SHEAR

- ♦ Lame finemente seghettate in acciaio INOX di altissima qualità con finitura a specchio, regolabili tramite vite
Finely serrated blades made of very high quality stainless steel with mirror finish, adjustable screw
- ♦ Manici in acciaio inox anti-scivolo con zigrinatura interna ed esterna
Non-slip stainless steel handles with internal and external knurling
- ♦ Meccanismo a molla per un utilizzo senza sforzo
Spring mechanism for effortless use
- ♦ Chiusura a leva nell'estremità del manico
Lever closure at the end of the handle

Codice		mm	gr		Barcode
223901	Lama cromata / <i>Chromed blade</i>	250	265	6	8033116545365
223901I	Lama INOX / <i>Stainless steel blade</i>	250	260	6	8033183552198



224024 TRINCIAPOLLO TIPO GAZZELLA GAZZELLA POILTRY SHEAR

- ♦ Lame finemente seghettate in acciaio INOX di altissima qualità con finitura a specchio, regolabili tramite vite
Finely serrated blades made of very high quality stainless steel with mirror finish, adjustable screw
- ♦ Manici in acciaio inox anti-scivolo con zigrinatura interna ed esterna
Non-slip stainless steel handles with internal and external knurling
- ♦ Meccanismo a molla interna
Internal spring mechanism
- ♦ Sistema di blocco delle lame
Blade locking system

Codice		mm	gr		Barcode
224024	Lama cromata / <i>Chromed blade</i>	240	265	6	8033116545396
224025I	Lama INOX / <i>Stainless steel blade</i>	240	260	6	8033116545419



224302 SCHIACCIANOCI CLASSICO
CLASSIC NUTCRACKER

Codice		mm	gr		Barcode
224302	Cromata / Chromed	170	84	6	8033183559449
224302I	INOX / Stainless steel	170	210	6	8033116545495

224401CR MASTICATORE STANDARD
STANDARD MASTICATOR

- ♦ *Lame e controlame curve, dentate, in acciaio con finitura lucida*
Polished, toothed blades and counter blades in steel with a polished finish
- ♦ *Manici con zigrinatura esterna anti-scivolo, molla a bovolo e chiusura a leva nell'estremità del manico-*
Handles with external anti-slip knurling with volute spring e lever closure at the end of the handle
- ♦ *Vite centrale regolabile*
Central adjustable screw

Codice		mm	gr		Barcode
224401CR	Cromata / Chromed	190	260	6	8033116545457
224402	INOX / Stainless steel	190	251	6	8033116545464



PREZIOSI ALLEATI DI BELLEZZA

PRECIOUS ALLIES OF BEAUTY

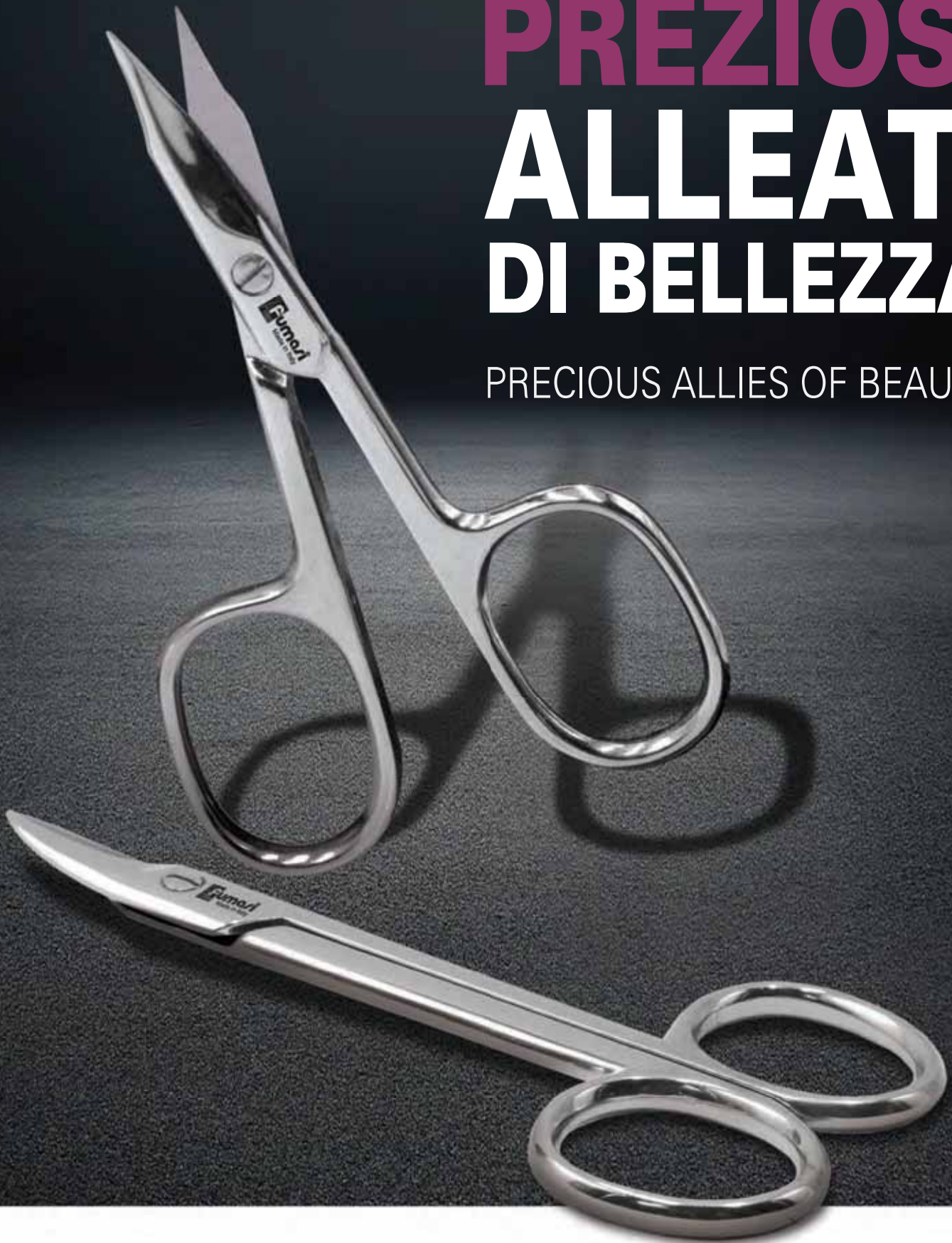

LINEA PRO
PRO LINE

380 Forbici per manicure e pedicure
Manicure and pedicure scissors

384 Cartelle espositive
Exhibition folders

Manicure e pedicure

Manicure & pedicure

- 1** Forbici in acciaio al carbonio C50 di altissima qualità con rivestimento nichelato e finitura lucida; prodotti davvero eccezionale con materiali di prima scelta e un ottimo design.

High quality C50 carbon steel scissors with nickel-plated coating and glossy finish; truly exceptional products with first choice materials and a great design.

- 2** Lama temperate ed affilate a mano per offrire un'elevata capacità di taglio e una lunga durata del filo.

Hardened and hand-sharpened blades to offer a high cutting capacity and a long life of the wire.

- 3** Vengono sottoposte a rigidi controlli di qualità da parte di esperti artigiani.

Are subjected to strict quality controls by expert craftsmen.

221901 FORBICI UNGHIE NAILS SCISSORS

Codice		mm	gr		Barcode
221901	Lama retta / Straight blade	90	21	12	8033116545747
221902	Lama curva / Curved blade	90	21	12	8033116545754



221007 FORBICI UNGHIE LANCIA NAIL TOWER POINT SCISSORS

- Particolari punte a lancia, che con la forma sottile e lanciata, rendono le forbici ideali per raggiungere i punti più difficili
- Particular spear point, which with the thin and slender shape, makes the ideal scissors to reach the most difficult points*

Codice		mm	gr		Barcode
221007	Lama retta / Straight blade	90	20	12	8033116545808
221008	Lama curva / Curved blade	90	20	12	8033116545815



220801 FORBICI PELLE CUTICLE SCISSORS

Codice		mm	gr		Barcode
220801	Lama retta / Straight blade	90	15	12	8033116545853
220802	Lama curva / Curved blade	90	15	12	8033116545860



221001 FORBICI PELLE LANCIA CUTICLE TOWER POINT SCISSORS

- Particolari punte a lancia, che con la forma sottile e slanciata, rendono le forbici ideali per raggiungere i punti più difficili
Particular spear point, which with the thin and slender shape, makes the ideal scissors to reach the most difficult points

Codice		mm	gr		Barcode
221001	Lama retta / Straight blade	90	17	12	8033116545877
221002	Lama curva / Curved blade	90	17	12	8033116545884



223003 FORBICI PEDICURE PEDICURE SCISSORS

- Particolari punte indicate per il taglio di unghie dure o incarnite
Special tips indicated for cutting hard or ingrown nails
- Lunghi manici per permettono una leva maggiore con il minimo sforzo
Long handles to allow greater leverage with minimum effort

Codice		mm	gr		Barcode
223003	Lama retta / Straight blade	105	30	12	8033116544443
223005	Lama curva / Curved blade	105	30	12	8033116545938



222501 FORBICI PELI NASO NOSE HAIR SCISSORS

- Particolari punte con estremità tonda per tagliare in modo sicuro peli del viso e baffi
Particular tip with round end for safe cutting facial hair and mustache

Codice		mm	gr		Barcode
222501	Lama retta / Straight blade	95	17	12	8033116545945
222502	Lama curva / Curved blade	95	17	12	8033116545952
222503	Lama retta / Straight blade	105	30	12	8033116545969
222504	Lama curva / Curved blade	105	30	12	8033116545976



222508 FORBICI BABY BABY SCISSORS

- Particolari punte arrotondate per tagliare in sicurezza le unghie dei più piccoli
Special rounded tips to safely cut nails of the little ones

Codice		mm	gr		Barcode
222508	Lama retta / Straight blade	90	19	12	8033116545983
222509	Lama curva / Curved blade	90	19	12	8033116545990



222235 FORBICI RICAMO
EMBROIDERY SCISSORS

- ♦ Punta molto sottili che permettono un taglio preciso nei punti più difficili
Very thin tips that allow a precise cut in the most difficult points

Codice	mm	gr	📄	Barcode
222235	90	15	12	8033183551337
222240	105	19	12	8033183551467



211554 TRONCHESE UNGHIE
NAIL NIPPER

- ♦ Lame con durezza necessaria per assicurare un taglio netto anche su unghie spesse
Blades with the hardness necessary to ensure a clean cut even on thick nails
- ♦ Meccanismo a molla bovolo
Bovolo spring mechanism
- ♦ Manici in acciaio con zigrinatura esterna per una presa più solida; sistema di blocco a gancio
Steel handles with external knurling for a more solid grip and hook locking system

Codice	mm	📄	Barcode
211554	120	12	8033116546393
211555	140	12	8033116546409



229540 TRONCHESE UNGHIE
NAIL NIPPER

- ♦ Lame con durezza necessaria per assicurare un taglio netto anche su unghie spesse
Blades with the hardness necessary to ensure a clean cut even on thick nails
- ♦ Meccanismo a gancio a molla
Spring hook mechanism
- ♦ Manici in acciaio con zigrinatura esterna per una presa più solida
Steel handles with external knurling for a more solid grip

Codice	mm	📄	Barcode
229540	110	12	8033116546355
229550	120	12	8033116546379



225104 TRONCHESE PELLE
CUTICLE NIPPER

- ♦ Lame ben affilate, garantiscono maggiore robustezza e precisione nel taglio delle pellicine
Well sharpened blades guarantee greater strength and precision in the cut of the cuticles
- ♦ Meccanismo a gancio a molla
Spring hook mechanism

Codice	mm	📄	Barcode
225104	90	12	8033116546348
225109	100	12	8033183552495



211735 TAGLIAUNGHIE
NAIL CLIPPER

- ♦ Lima per unghie in metallo integrata
Integrated metal nail file
- ♦ Con catenella per appensione
With chain for hanging

Codice	mm		Barcode
211735	80	24	8033116546324



211625 TAGLIAUNGHIE TASCABILE
POCKET NAIL CLIPPER

- ♦ Lima per unghie in metallo integrata
Integrated metal nail file
- ♦ Con catenella per appensione
With chain for hanging

Codice	mm		Barcode
211625	55	24	8033116546317



■ Cartelle espositive

Exhibition folders

890503 CARTELLA ESPOSITIVA FORBICI LAVORO
WORKING SCISSORS EXHIBITION FOLDER

Codice	Pezzi / Pieces		Barcode
890503	12	3 x 223240 - 223250 - 223260 - 223260	1 8033116546980



890502 CARTELLA ESPOSITIVA FORBICI MANICURE
MANICURE SCISSORS EXHIBITION BRIEFCASE

Codice	Pezzi / Pieces		Barcode
890502	12	6 x 221901 - 220801	1 8033116546973



890504 CARTELLA ESPOSITIVA TAGLIAUNGHIE
ASSORTITI
EXHIBITION FOLDER NAIL CUTTERS ASSORTED

Codice	Pezzi / Pieces		Barcode
890504	12	Cartella / Exhibition folder 6 X 211735 - 6 X 211625	1 8033116546997



890506 CARTELLA ESPOSITIVA TAGLIAUNGHIE
GRANDE
EXHIBITION FOLDER NAIL CUTTERS GREAT

Codice	Pezzi / Pieces		Barcode
890506	12	Cartella / Exhibition folder art. 211735	1 8033183846914



890507 CARTELLA ESPOSITIVA TAGLIAUNGHIE
TASCABILE PICCOLO
EXHIBITION FOLDER NAIL CUTTERS SMALL POCKET

Codice	Pezzi / Pieces		Barcode
890507	12	Cartella / Exhibition folder art. 211625	1 8033183551849



890501 CARTELLA ESPOSITIVA PINZETTE COLORATE
COLORED TWEEZERS EXHIBITION FOLDER

Codice	Pezzi / Pieces		Barcode
890501	12		1 8033116546966

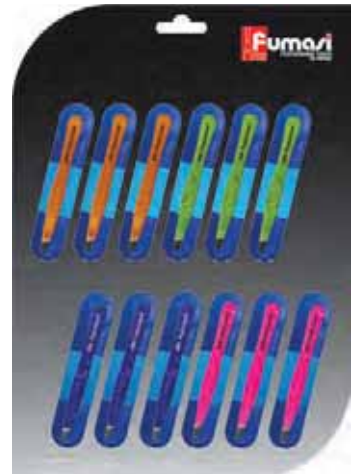

890505 CARTELLA ESPOSITIVA LIMETTE ZAFFIRO
SAPPHIRE LIMES EXHIBITION BRIEFCASE

Codice	Pezzi / Pieces		Barcode
890505	12		1 8033116547000





CERTIFICATO

**CERTIFICAT
CERTIFICATE**

N° AI 1282-9001

125 DS 02 X
Ind 0 – Juin 21



Certifichiamo che il Sistema di Gestione della società:
Nous certifions par la présente que le Système de Management de la société :
We hereby certify that the Management System of the company:

GIMAP S.R.L.

è conforme ai requisiti della norma:
est conforme aux exigences des normes suivantes :
is in compliance with the requirements of the following standards:

ISO 9001 :2015

Il campo di attività del sistema di gestione è il seguente:
Le domaine d'application du système de management est le suivant :
The scope of the Management System is:

**Produzione e commercializzazione di forbici e di utensileria professionale
Production et commercialisation de ciseaux et outils professionnels
Production and dealing of scissors and hand tools**

SETTORE EAC17

Sviluppate presso i centri operativi di
Centres opérationnels de
Developed in the operational centres of:

Zona Industriale Giabbio – 23834 Premana (LC) Italia

Il presente certificato rimarrà in vigore fino alla data di validità salvo comunicazione contraria, a condizione che l'attuazione e la conformità del sistema di gestione siano giudicate soddisfacenti nel corso delle verifiche di sorveglianza e che vengano rispettate le condizioni del contratto stipulato con AB Certification.

Ce certificat demeurera en vigueur jusqu'à sa fin de validité à moins d'avis contraire, à condition que la mise en place et la conformité du Système de Management soient jugées satisfaisantes lors des audits de surveillance et que les conditions du contrat de AB Certification soient observées.

This certificate will remain in force until the validity date, provided that the compliance and implementation of the Management System are found to be satisfactory at follow-up audits and that AB Certification contract rules are fulfilled.

Emesso a Parigi il 27 settembre 2021
Fait à Paris, le 27 septembre 2021
Issued in Paris on the 27th of September, 2021

Data di validità : 29 settembre 2024
Date de fin validité : 29 septembre 2024
Expiry date : 29th of September, 2024

Georges ABI RACHED

Il rappresentante di AB Certification
Le Représentant d'AB Certification

Il Rappresentante dell'Impresa
Le Représentant de l'Entreprise

*Il presente certificato è di proprietà di AB Certification. In caso di richiesta esso dovrà essere restituito a : AB Certification - 17 rue de Châteaudun - 75009 Parigi (Francia) tramite la delegazione italiana AB Certification - Via Luigi Scrocchi, 7 - 00127 Roma.
Per informazioni aggiornate circa eventuali variazioni intervenute nello stato della certificazione di cui al presente certificato, si prega di contattare il numero telefonico +39-0686766082 o fax +39-0686983191 o alla mail info@abcertificazione.it*

ZEICHENGENEHMIGUNG MARKS APPROVAL

GIMAP SRL
Zona Industriale Giabbio
23834 PREMANA LC
Italy

ist berechtigt, für ihr Produkt /
is authorized to use for their product

Zange, isoliert
Pliers, insulated

die hier abgebildeten markenrechtlich geschützten Zeichen
für die ab Blatt 2 aufgeführten Typen zu benutzen /
the legally protected Marks as shown below for the types referred to on page 2 ff.

A und/oder - and/or **G** oder/for **H**

Geprüft und zertifiziert nach /
Tested and certified according to

DIN EN IEC 60900 (VDE 0682-201):2019-04; EN IEC 60900:2018

Das Produkt entspricht den Anforderungen des deutschen Produktsicherheitsgesetzes (ProdSG)
hinsichtlich der Gewährleistung von Sicherheit und Gesundheit.

*The product covers the requirements of the German Act "Produktsicherheitsgesetz (ProdSG)"
regarding the ensurance of safety and health.*

Befristet zum / *valid until*: 2024-12-31

VDE Prüf- und Zertifizierungsinstitut GmbH
VDE Testing and Certification Institute
Zertifizierungsstelle / *Certification*



M. Tasotti

Aktenzeichen: 5006807-3940-0011 / 271676

File ref.:

Ausweis-Nr. 40052138

Certificate No.

Weitere Bedingungen siehe Rückseite und Folgeblätter /
further conditions see overleaf and following pages

Offenbach, 2020-07-22

Blatt 1

Page

VDE Zertifikate sind nur gültig bei Veröffentlichung unter:
VDE certificates are valid only when published on:

<http://www.vde.com/zertifikat>
<http://www.vde.com/certificate>



Indice numerico

Numeric index

Codice Code	Pag.	Codice Code	Pag.	Codice Code	Pag.	Codice Code	Pag.	Codice Code	Pag.	Codice Code	Pag.
001101	58	072003	154	100472	218	148903	198	153617	68	181607R	326
001102	58	072003L	155	100472V	294	148903M	198	153621	68	181608	326
001103	58	072004	154	100475	195	148904	198	153630	68	181608R	326
002011	59	075001	154	100719	289	148905	198	153710	68	182001	174
002111	59	076001	155	100720	291	148907	198	153714	68	182101	175
003201	59	080501	131	100720T	291	148907M	198	153718	68	185040	75
003202	59	080502	131	100721	288	149001	199	153722	68	185050	75
003301	58	080503	131	100721P	98	149002	199	153731	68	185060	75
003302	58	080504	131	100722	288	149003	199	153810	68	185080	75
011101	60	080505	131	100722E	63	149004	199	153813	68		
011102	60	080506	131	100722P	98	149005	199	153817	68		
016102	60	080507	131	100725PP	195	149301	199	153821	68		
016103	61	080508	131	100726	290	149301M	199	153830	68		
021101	60	080509	131	100805	95	149302	199	16025FB	95		
021102	60	080510	131	100806	96	149303	199	16025FN	95		
021103	60	080511	131	101402	290	149304	199	16025FN	95		
023501	82	080512	131	101402T	290	149305	199	163000	70		
031001	59	080513	131	101420	289	149532	199	163000B	70		
032101	61	080514	131	101420T	289	150000	199	163001	70		
033001	61	080515	131	102600	99	150001	199	163002	70		
033501	82	080516	131	102600V	295	150002	199	163100	70		
039001	131	081001	131	104020	43	150003	199	163101	70		
039002	131	081002	131	104101	45	150005	199	163201	71		
039003	131	081003	131	104102	45	150006	199	163210	71		
045001	64	081004	131	104201	46	150100	199	163290	71		
045020	50	081005	131	104202	46	150101	199	163400	72		
045021	50	081006	131	104203	46	150102	199	163401	72		
045022	50	081007	131	1124N	67	150103	199	163501	72		
045024	50	081008	131	124101R	325	150105	199	163701	72		
045026	50	081009	131	124103	324	150106	199	163801	72		
045027	51	081010	131	124104	324	150202	200	163802	72		
045028	51	081011	131	124105	324	150203	200	163802	72		
045029	51	081012	131	124106	324	150204	200	165501P	75		
045420	50	081013	131	124107	324	150205	200	165601	73		
045421	50	081014	131	124108	324	150206	200	165602	73		
045422	50	081015	131	124109	324	150207	200	165603	74		
045423	50	081016	131	125801	67	150302	200	165604	74		
045520	50	093201	61	127301	324	150303	200	165605	74		
045521	50	093202	61	128301	325	150304	200	167200	69		
045522	50	093210	61	128302	325	150305	200	167201	69		
045523	50	093220	61	128303	325	150306	200	167202	69		
053001	51	094025	52	128304	325	150307	200	167350	69		
053002	51	094080	63	130000	324	150401	200	167350E	69		
053003	51	094085	64	130001	325	150401R	200	167351	69		
053004	51			130002	325	150402	200	167351E	69		
053005	51			131001	325	150402R	200	167352	69		
053006	51			131002	325	150403	200	167504	69		
054001	52			131003	325	150403R	200	167505	69		
054002	52	100001	62	14025FB	95	150404	200	167506	69		
054003	52	100002	98	14025FN	95	150404R	200	180001	174		
054004	52	100003	62	14036FB	95	150503	200	180101	175		
054004	52	100201	97	14036FN	95	150505	200	180103	175		
054501	52	10025FB	95	148001	198	150506	200	18025FB	95		
054502	52	10025FN	95	148002	198	150507	200	18025FN	95		
054503	52	100422	293	148003	198	150510	200	181001	174		
054504	52	100423	293	148005	198	150601	201	181501	174		
070001	154	100424	291	148006	198	150602	201	181502	175		
070002	154	100424C	293	148007	198	150603	201	181503	175		
070003	154	100425	292	148008	198	150604	201	181599	326		
070004	154	100425PP	194	148009	198	150605	201	181599R	326		
070005	154	100426	292	148010	198	150606	201	181599RR	326		
070006	154	100428	293	148102	197	150607	201	181600	326		
070007	154	100429	294	148103	197	150608	201	181600R	326		
070008	154	100429PP	194	148104	197	150609	201	181601	326		
070009	154	100449	100	148105	197	153510	67	181601G	326		
070010	154	100450	100	148106	197	153502	292	181601GR	326		
070011	154	100450V	295	148107	197	153514	67	181601R	326		
070012	154	100455	195	148108	197	153518	67	181602	326		
070013	154	100456	99	148803	198	153522	67	181602R	326		
071501	155	100457	99	148803M	198	153531	67	181605	326		
072001	154	100470	100	148804	198	153610	68	181606	326		
072002	154	100470V	295	148805	198	153613	68	181607	326		
072002L	155	100471	100								

2

20025FB	95
20025FN	95
20036FB	95
20036FN	95
20048FB	95
20048FN	95
20076FB	95
20076FN	95
201001F	324
201002F	324
201101	56
201101F	324
201101P	55
201102	56
201102F	324
201102P	55
201103	56
201103P	55
207201	57
207201P	55
207202	57
207202P	55
207401	57
207401P	55
207402	57
207402P	55
207502	66
208101	56
208101P	55
208102	56
208102P	55
208601	81
208601A	81
208602	81
208602A	81
208603	81
208603A	81
208604	81
208604A	81
208701	80
208702	80
209001	80
209101	80
209201	81
209202	81
209301	87
209401	87
209402	87
209403	88
209433	89
209434B	89
209434C	89
209434D	89
209435	85
209435M	85
209449	88
209452	84
209453	84
209501	90
209601	90

Indice numerico

Numeric index

Codice Code	Pag.	Codice Code	Pag.	Codice Code	Pag.	Codice Code	Pag.	Codice Code	Pag.	Codice Code	Pag.
209601	90	223322	311	225522	25	230823	227	231420	169	233490T	366
209721N	86	223323	362	225524	25	230827	308	231862	362	233490TB	367
209722	86	223501	178	225526	25	230828	308	231875	362	233490TGN	318
209723	86	223521	315	225528	25	230829	308	231876	362	233490TNS	367
209724	86	223525	316	225530	25	230830	16	231877	362	233495B	366
209749	84	223560	365	225540	25	230831	28	231878	362	234201	206
209751	85	223570	365	226024	23	230831B	26	231879	362	234202	206
209801	91	223580	365	226327	24	230832	316	231880	362	234203	206
209901	91	223710	367	226428	23	230833	15	231881	362	234204	206
211554	382	223710K	374	226528	23	230833P	15	232001	41	234205	206
211555	382	223711	367	226626	23	230834	15	232101	37	234301	206
211625	383	223712	367	226640	365	230834P	15	232101A	37	234375B	366
211735	383	223713	367	226641	365	230835	17	232101AN	38	234380T	366
220121	30	223713K	374	226650	24	230836	17	232101N	38	234380TGN	318
220221	30	223714	367	226730D	24	230837	16	232101P	37	235001	208
220707	374	223714K	374	226730S	24	230838	17	232101PA	37	235002	208
220801	380	223718	310	226735	24	230841	14	232101PAN	38	235003	208
220802	380	223719	376	226801	24	230841P	14	232101PN	38	235101	208
221001	381	223721	310	226901	24	230842	14	232106	38	235102	208
221002	381	223723	310	227831	311	230842P	14	232201	41	235103	208
221007	380	223819	376	228620	25	230842T	14	232401	39	235104	208
221008	380	223820	372	228625	25	230842TC	14	232501	40	235105	208
221316	66	223821	372	228630	25	230845	13	232501A	40	235201	209
221320	66	223822	376	228720	25	230845K	13	232501P	38	235202	209
221901	380	223822I	376	228821	29	230845P	13	232601	40	235203	209
221902	380	223824	365	228921	29	230846	13	232601A	40	235204	209
222235	382	223825	365	229001	30	230846P	13	232701	39	235205	209
222240	382	223845	372	229021	29	230847	12	232701A	39	235206	209
222501	381	223850	311	229025	31	230849	14	232702	40	235301	207
222502	381	223900	313	229026	30	230850	28	232702A	40	235302	207
222503	381	223901	377	229027	31	230850B	27	232703	39	235401	208
222504	381	223901I	377	229101	30	230850S	29	232703A	39	235402	208
222508	381	223918	315	229121	29	230851B	312	232801	41	235403	208
222509	381	223919	349	229125	31	230851R	312	233101	81	235501	209
222602	78	223924	377	229126	30	230857	312	233102	81	235601	209
222603	78	223924I	377	229127	31	230858	313	233103	81	235701	209
222643	77	223930	349	229203	32	230859	314	233104	81	235801	209
222643P	77	223931	347	229204	32	230860	314	233110	371	236001	206
222644	77	223931L	361	229226	31	230861	314	233126	372	236002	206
222644P	77	223934	347	229227	32	230862	311	233127	372	236003	206
222645	77	223934L	361	229301	30	230863	314	233128	373	236004	205
222645P	77	223935	346	229302	30	230864	312	233129	373	236005	205
222646	77	223935L	361	229326	31	230865	310	233130	373	236006	205
222646P	77	223936	349	229327	32	230866	313	233131	373	236007	205
222647	77	223937	352	229426	31	230868	315	233132	373	236101	206
222647P	77	223938	352	229501	21	230869	315	233134	373	236102	206
222648	78	223941	28	229526	31	230870	369	233135	373	236103	206
222648P	78	223943	27	229540	382	230876	309	233175	371	236501	208
222649	78	223945	317	229550	382	230877	309	233201	82	236502	208
222649P	78	223946	317	229601	21	230878	309	233250	318	236525	207
222650	78	223949	333	229701	22	230879	310	233255B	366	236530	207
222650P	78	223949R	333	229801	22	230880	310	233255T	366	236535	207
223001	165	223951	333	229901	22	230881	346	233255TB	367	236540	207
223003	381	224024	377	230002	18	230882	327	233255TGN	318	236541	205
223005	381	224025I	377	230005	18	230883	327	233255TNS	367	236542	205
223140	364	224145	372	23007R	18	230886	352	233265B	366	236543	205
223150	364	224203	78	23008C	18	230885	348	233265T	366	236544	205
223160	364	224204	69	230102	18	230887	348	233265TB	367	236545	205
223240	364	224210	78	230106	18	230889	348	233265TGN	318	236625	207
223245	364	224210P	78	230201	16	230888	348	233265TNS	367	236630	207
223250	364	224211	78	230301	16	230901	83	233301	82	236635	207
223250C	364	224211P	78	230401N	19	230902	83	233308	372	236640	207
223255	364	224212P	78	230401P	19	231101	83	233309	372	236641	204
223260	364	224213	78	230404N	19	231101L	83	233401	81	236642	204
223260C	364	224302	378	230404P	19	231102	83	233401A	81	236643	204
223265	364	224302I	378	230810	15	231102L	83	233475B	366	236901	207
223270	364	224401CR	378	230810P	16	231301	83	233480T	366	237016	227
223280	364	224402	378	230820	28	231302	83	233480TB	367	237018	227
223307	365	224645	69	230821	27	231401	168	233480TGN	318	237018S	227
223308	365	224651	128	230821B	26	231405	169	233480TNS	367	237019	227
223309	365	225104	382	28 230821S	28	231410	168	233485B	366	237019S	227
223310	365	225109	382	27 230822	27	231415	169	233485S	366	237020	227

Indice numerico

Numeric index

Codice Code	Pag.	Codice Code	Pag.	Codice Code	Pag.	Codice Code	Pag.	Codice Code	Pag.	Codice Code	Pag.
237020S	227	237612P	228	240016	112	241815	116	255003	44	255405L	45
237021	227	237614	203	240017	112	241820	116	255006	44	255408	45
237021S	227	237616	203	240018	112	241825	116	255009	44	255520	45
237022	227	237618	203	240019	112	241827	116	255011	44	255521	45
237022S	227	237620	203	240301	114	241830	116	255012	44	255522	45
237118P	224	237625	203	240302	114	241840	116	255201	44	255523	45
237119P	224	237630	203	240303	114	241845	116	255203	44	255601	45
237120P	224	237631	229	240304	114	241850	116	255204	44	255603	45
237121P	224	237632	229	240305	114	241901	115	255207	44	255701	45
237122P	224	237633	229	240306	114	241905	115	255208	44	255703	45
237212Q	228	237634	229	240307	114	241906	115	255400	48	2565F06	46
237214P	225	237635	229	240308	114	241912	115	255400B	48	2565F07	46
237214Q	228	237636	229	240309	114	241913	115	255401	45	2565F08	46
237216	227	237637	229	240401	114	241914	115	255402	45	2565F09	46
237216P	225	237638	229	240402	114	241920	115	255403	45	2565F10	46
237216Q	228	237639	229	240403	114	241921	115	255403L	45	2565F15	46
237218	227	237640	229	240404	114	241922	115	255405	45	2565F20	46
237219	227	237641	229	240410	114	241923	115	255405L	45	2565F25	46
237220	227	237642	229	240501	112	242101	47	255408	45	2565F27	46
237221	227	237644	229	240601	112	242101E	47	255520	45	2565F30	46
237222	227	237643	233	24076FB	95	244001	49	255521	45	2565F40	46
237314SP	225	237645	229	24076FN	95	244010	49	255522	45	2565F45	46
237316SP	225	237646	229	240801	112	244201	49	255523	45	257502V	46
237318P	224	237647	229	240901	113	244210	49	255601	45	257506	46
237319P	224	237702	226	240902	113	244211	48	255603	45	260003	137
237320P	224	237711	226	240903	113	244212	48	255701	45	260003L	137
237321P	224	238002	16	240904	113	244700N	47	255703	45	260005	137
237322P	224	238010	15	240905	113	244701N	47	2565F06	46	260005L	137
237412	228	238010P	16	240906	113	244702N	47	2565F07	46	260006	137
237414	228	238030	16	240907	113	244703N	47	2565F08	46	260006L	137
237414P	225	238033	15	240908	113	244705N	47	2565F09	46	260007	137
237414SP	225	238034	15	240909	113	2448P000	47	2565F10	46	260007L	137
237416	228	238035	17	240910	113	2448P00	47	2565F15	46	260201	137
237416P	225	238036	17	240911	113	2448P0	47	2565F20	46	260201L	137
237416SP	225	238037	16	240912	113	2448P1	47	2565F25	46	260202	137
237512	226	238038	17	240913	113	244901	47	2565F27	46	260202L	137
237512A	225	238041	14	241001	113	245020	43	2565F30	46	260204	137
237512G	226	238042	14	241106	113	245021	43	2565F40	46	260204L	137
237514	226	238045	13	241107	113	245022	43	2565F45	46	260206	137
237514A	225	238046	13	241108	113	245024	43	257502V	46	260206L	137
237514G	226	238201	204	241109	113	245026	43	257506	46	260301	138
237514O	225	238202	204	241110	113	245420	43	260003	137	260301L	138
237514SA	225	238203	204	241115	113	245421	43	260003L	137	260302	138
237514SO	225	238206	203	241120	113	245422	43	260005	137	260302L	138
237516	226	238208	203	241125	113	245423	43	260005L	137	260304	138
237516A	225	238210	203	241127	113	245520	44	260006	137	260304L	138
237516G	226	238212	203	241130	113	245521	44	260006L	137	260306	138
237516O	225	238216	203	241140	113	245522	44	260007	137	260306L	138
237516SA	225	238220	203	241145	113	245523	44	260007L	137	260401	138
237516SO	225	238501	233	241201	114	245622	44	260201	137	260401L	138
237601	203	238502	233	241301	113	245722	44	260201L	137	260402	138
237602	203	238503	233	241500	115	245905	126	260202	137	260402L	138
237602E	229	238504	233	241501	115	245906	126	260202L	137	260404	138
237602P	228	238505	233	241502	115	245907	126	260204	137	260404L	138
237603	203	238506	233	241504	115	245908	126	260204L	137	260405	138
237603E	229	238507	233	241505	115	245909	126	260206	137	260405L	138
237603P	228	238508	233	241506	115	245910	126	260206L	137	260406	138
237604	229	240001	112	241507	115	245911	126	260301	138	260406L	138
237604P	228	240002	112	241508	115	245912	126	260301L	138	260408	138
237605	229	240003	112	241509	115	245913	126	260302	138	260408L	138
237605P	228	240004	112	241510	115	245914	126	260302L	138	2604015L	138
237606	229	240005	112	241706	116	245923	126	260304	138	260506	139
237606P	228	240006	112	241710	116	245924	126	260304L	138	260506L	139
237607	229	240007	112	241720	116	245925	126	260306	138	260507	139
237607P	228	240008	112	241725	116	245926	126	260306L	138	260507L	139
237608	229	240009	112	241730	116	245927	126	260401	138	260508	139
237608P	228	240010	112	241740	116	245928	126	260401L	138	260508L	139
237609P	228	240011	112	241750	116	245929	126	260402	138	260509	139
237610	229	240012	112	241760	116	245930	126	260402L	138	260509L	139
237610P	228	240013	112	241780	116	255000	48	260404	138	260510	139
237612	203	240014	112	241806	116	255000B	48	260404L	138	260515	139
237612E	229	240015	112	241810	116	255001	44	260405	138	260515L	139

Indice numerico
Numeric index

Codice <i>Code</i>	Pag.	Codice <i>Code</i>	Pag.	Codice <i>Code</i>	Pag.	Codice <i>Code</i>	Pag.	Codice <i>Code</i>	Pag.	Codice <i>Code</i>	Pag.
260520	139	270010	248	270514L	253	273001	267	275016	250	275013HL	254
260520L	139	270010C	249	270516L	253	273010	248	275016G	251	275013HLL	254
260525	139	270010CE	252	270516LL	253	273101	267	275016L	251	275013HLLLL	254
260525L	139	270010L	249	270517	253	273201	267	275016LL	251	275014HL	254
260527	139	270011	248	270518	253	273301	267	275016XL	251	275014HLL	254
260527L	139	270011C	249	270519	253	273401	267	275017	250	275014HLLLL	254
260530	139	270011CE	252	270530	261	273501	267	275018	250	275014HLLLLL	254
260530L	139	270011L	249	270531	261	274002	193	275019	250	275014HLLLLLL	254
260540	139	270012	248	270532	261	274003	193	275020	250	275014HLE	254
260540L	139	270012C	249	271001	248	274004	193	275021	250	275014HLLLE	254
260610	139	270012L	249	272001	248	274005	193	275022	250	275014HLLLE	255
260610L	140	270013	248	2720016	248	274006	193	275023	250	275015HL	255
260615	139	270013C	249	2720016C	249	274007	193	275035H	254	275015HLLLL	255
260615L	140	270013CE	252	2720016CE	252	274008	193	275035HL	254	275015HLE	255
260620	139	270013L	249	2720016L	249	274009	193	275040H	254	275016HLL	255
260620L	140	270014	248	2720017	248	274010	193	275040HL	254	275016HLLLL	255
260625	139	270014C	249	2720017C	249	274011	193	275050	254	275016HLLLLL	255
260625L	140	270014CE	252	2720017CE	252	274012	193	275050HL	254	275016HLE	255
260627	139	270014L	249	2720017L	249	274020	193	275050HLL	254	275016HLLLE	255
260627L	140	270015	248	2720018	248	275001	250	275050HLLLL	254	275016HLLLE	255
260630	139	270015C	249	2720018C	249	275002	250	275050HLLLLL	254	275017HLL	255
260630L	140	270015CE	252	2720018CE	252	275003	250	275050HLLLE	254	275017HLLLLL	255
260640	139	270015L	249	2720018L	249	275004	250	275055H	254	275018HLLLL	255
260640L	140	270016	248	2720019	248	275004LL	251	275055HL	254	275018HLLLLLLL	255
260701	136	270016C	249	2720019C	249	275004XL	251	275055HLL	254	275018HLLLE	255
260702	136	270016CE	252	2720019CE	252	275005	250	275055HLLLL	254	275018HLLLE	255
260703	136	270016L	249	2720019L	249	275006	250	275055HLLLLL	254	275020HLL	255
260704	136	270017	248	2720020	248	275006G	251	275055HLE	254	275020HLLLLL	255
260705	136	270017C	249	2720020C	249	275006L	251	275060H	254	275020HLLLE	255
260706	136	270017CE	252	2720020CE	252	275006LL	251	275060HL	254	275022HLL	255
260707	136	270017L	249	2720021	248	275006XL	251	275060HLL	254	275022HLLL	255
260708	136	270018	248	2720021CE	252	275007	250	275060HLLLL	254	275022HLLLLL	255
261001	136	270018C	249	2720022	248	275007G	251	275060HLLLLL	254	275022HLLLE	255
261301	129	270018CE	252	2720055CE	252	275007L	251	275060HLE	254	275022HLLLE	255
261301P	129	270018L	249	2720056CE	252	275007LL	251	275065H	254	275024HLLLLLLL	255
263102	156	270019	248	2720065CE	252	275007XL	251	275065HL	254	275025HLLLLLLL	255
263201	157	270019C	249	2720066CE	252	275008	250	275065HLL	254	275025HLLLE	255
263301	156	270019CE	252	2720085CE	252	275008G	251	275065HLLL	254	275025HLLLE	255
263301E	156	270019L	249	2720086CE	252	275008L	251	275065HLLLLL	254	275028HLLLLLLL	255
270000	248	270020	248	2720087CE	252	275008LL	251	275070H	254	275030HLLLLLLL	255
270000C	249	270020C	249	2720501	253	275008XL	251	275070HL	254	275050P	255
270001	248	270020CE	252	2720502	253	275009	250	275070HLL	254	275050PL	255
270001C	249	270021	248	2720502L	253	275009G	251	275070HLLL	254	275055P	255
270002	248	270021CE	252	2720503	253	275009XL	251	275080H	254	275055PL	255
270002C	249	270022	248	2720503L	253	275010	250	275080HL	254	275060P	255
270003	248	270055CE	252	2720504	253	275010G	251	275080HLL	254	275060PL	255
270003C	249	270056CE	252	2720505	253	275010L	251	275080HLLL	254	275060PLL	255
270003CE	252	270065CE	252	2720505L	253	275010LL	251	275080HLLLL	254	275060PLLL	255
270004	248	270066CE	252	2720506	253	275010XL	251	275080HLLLLL	254	275060PLLLL	255
270004C	249	270085CE	252	2720506L	253	275011	250	275080HLE	254	275065PL	255
270004CE	252	270086CE	252	2720506LL	253	275011G	251	275090H	254	275065PLL	255
270004L	249	270087CE	252	2720507	253	275011L	251	275090HLL	254	275065PLLL	255
270005	248	2720501	253	2720507L	253	275011LL	251	275010H	254	275065PLLLL	255
270005C	249	2720502	253	2720508	253	275011XL	251	275010HL	254	275070P	255
270005CE	252	2720502L	253	2720508L	253	275012	250	275010HLL	254	275070PL	255
270005L	249	2720503	253	2720509	253	275012G	251	275010HLLL	254	275080P	255
270006	248	2720503L	253	2720509L	253	275012L	251	275010HLLLL	254	275080PL	255
270006C	249	2720504	253	2720513	253	275012LL	251	275010HLLLLL	254	275080PLL	255
270006CE	252	2720505	253	2720514	253	275012XL	251	275010HLE	254	275080PLLL	255
270006L	249	2720505L	253	2720514C	253	275013	250	275010HLLLE	254	275080PLLLL	255
270007	248	2720506	253	2720514L	253	275013G	251	275010HLLLE	254	275080PLLLL	255
270007C	249	2720506L	253	2720516L	253	275013XL	251	275011HL	254	275080PLLLL	255
270007CE	252	2720506LL	253	2720516LL	253	275014	250	275011HLL	254	275090PL	255
270007L	249	2720507	253	2720517	253	275014G	251	275011HLLL	254	275010P	255
270008	248	2720507L	253	2720518	253	275014L	251	275012HL	254	275010PLL	255
270008C	249	2720508	253	2720519	253	275014LL	251	275012HLL	254	275010PLLL	255
270008CE	252	2720508L	253	2720530	261	275014XL	251	275012HLLL	254	275010PLLLL	255
270008L	249	2720509	253	2720531	261	275015	250	275012HLLLL	254	275010PLLLL	255
270009	248	2720509L	253	2720532	261	275015G	251	275012HLLLLL	254	275010PLLLL	255
270009C	249	2720513	253	2721001	248	275015L	251	275012HLE	254	275010PLLLL	255
270009CE	252	2720514	253	2722001	248	275015LL	251	275012HLLLE	254	275011PL	256
270009L	249	2720514C	253	2722001C	250	275015XL	251	275012HLLLE	254	275011PLL	256

Indice numerico

Numeric index

Codice Code	Pag.	Codice Code	Pag.	Codice Code	Pag.	Codice Code	Pag.	Codice Code	Pag.	Codice Code	Pag.
360016	146	363017	145	3607NV10K	374	37036FN	95	375036	149	383050	153
360016E	144	363017L	144	3607NV11	368	37048FB	95	375038	149	383055	153
360017	146	363018	145	3607NV12	368	37048FN	95	375041	149	383060	153
360017E	144	363018L	144	362005	143	37076FB	95	375046	149	383065	153
360017L	145	363019	145	362006	143	37076FN	95	375050	149	383070	153
360017LE	143	363019L	144	362401	148	372801	230	375501	150	383075	153
360018	146	363020	145	362601	147	372902	230	376001	150	383080	153
360018E	144	363021	145	362801	147	372903	230	376501	151	385041	152
360019	146	363021L	144	363001	148	372904	230	376502	151	385046	152
360019E	144	363022	145	363010	145	373001	231	377001	151	385050	152
360019L	145	363022L	144	363010L	144	373001B	231	377501	151	385055	152
360019LE	143	363023	145	363011	145	373019	149	377601	151	385060	152
360020	146	363024	145	363011L	144	373019L	150	377701	151	385065	152
360020E	144	363024L	144	363012	145	373021	149	378101	148	385070	152
360021	146	363026	145	363012L	144	373021L	150	378201	149	385075	152
360021E	144	363026L	144	363013	145	373022	149	380001	117	385080	152
360022	146	363027	145	363013L	144	373022L	150	380001S	118	385501	153
360022E	144	363027L	144	363014	145	373023	149	380002	117	386001	153
360022L	145	363028L	144	363014L	144	373024	149	380002S	118	386002	153
360022LE	144	363030	145	363015	145	373024L	150	380003	117	387001	153
360023	146	363030L	144	363015L	144	373026	149	380003S	118	388001	152
360023E	144	363032	145	363016	145	373027	149	380004	117	388101	152
360024	146	363032L	144	363016L	144	373027L	150	380004S	118		
360024E	144	360026	146	363017	145	373028	149	380005	117		
360024L	145	360027	146	363017L	144	373029L	150	380005S	118		
360024LE	143	360028	146	363018	145	373030	149	380006	117	400006	120
360025	146	360030	146	363018L	144	373030L	150	380006S	118	400007	120
360025E	144	360032	146	363019	145	373032	149	380007	117	400008	120
360026	146	360032L	144	363019L	144	373032L	150	380007S	118	400010	120
360026E	144	360008E	144	363020	145	373033	149	380008	117	400011	120
360027	146	360009E	144	363021	145	373033L	150	380008S	118	400012	120
360027E	144	360010E	144	363021L	144	373034	149	380009	117	400013	120
360027L	145	360011E	144	363022	145	373035L	150	380009S	118	400014	120
360027LE	143	360012E	144	363022L	144	373036	149	380010	117	400015	120
360028	146	360013E	144	363023	145	373036L	150	380010S	118	400016	120
360028E	144	360014E	144	363023L	145	373038	149	380011	117	400017	120
360030	146	360015E	144	363024	145	373038L	150	380012	117	400018	120
360030E	144	360016E	144	363024L	144	373040L	150	380012S	118	400019	120
360030L	145	360017E	144	363026	145	373041	149	380013	117	400020	120
360030LE	143	360018E	144	363026L	144	373041L	150	380013S	118	400021	120
360032	146	360019E	144	363027	145	373041L	150	380014	117	400022	120
360032E	144	360020E	144	363027L	144	373046	149	380014S	118	400023	120
360032L	145	360021E	144	363028L	144	373046L	150	380108	118	400024	120
360032LE	143	360022E	144	363030	145	373050	149	380109	118	400025	120
360173	157	360023E	144	363030L	144	373101	230	380109S	119	400027	120
3607NV07	368	360024E	144	363032	145	373102	232	380110	118	400030	120
3607NV08	368	360025E	144	363032L	144	373202	230	380110S	119	400032	120
3607NV09	368	360026E	144	364004	147	373203	230	380115	118	401701	120
3607NV10	368	360027E	144	364005	147	373204	230	380115S	119	402601	120
3607NV10K	374	360028E	144	364005L	147	373502A	231	380120	118	405004	120
3607NV11	368	360030E	144	364006	147	373502B	231	380120S	119	405005	120
3607NV12	368	360032E	144	364006L	147	373504A	231	380125	118	405006	120
362005	143	360033L	145	364007	147	373504B	231	380125S	119	405007	120
362006	143	360013LE	143	364007L	147	373506	232	380127	118	405008	120
362401	148	360017L	145	364008	147	373701	232	380127S	119	405009	120
362601	147	360017LE	143	364008L	147	373702	232	380130	118	405010	120
362801	147	360019L	145	364010	147	373702B	232	380130S	119	405011	120
363001	148	360019LE	143	364010L	147	373702N	232	380140	118	405012	120
363010	145	360022L	145	364012	147	373801	231	380140S	119	405013	120
363010L	144	360022LE	143	364014	147	373802	231	380145	118	405014	120
363011	145	360024L	145	364017	147	374001	233	380145S	119	410007	121
363011L	144	360024LE	143	364019	147	374402	233	380210	119	410008	121
363012	145	360027L	145	364510	146	374403	233	380801	117	410009	121
363012L	144	360027LE	143	364511	146	374404	233	380801S	118	410010	121
363013	145	360030L	145	364515	146	375022	149	380809S	119	410012	121
363013L	144	360030LE	143	364602	146	375023	149	381401	117	410013	121
363014	145	360032L	145	364603	146	375024	149	381401A	118	410014	121
363014L	144	360032LE	143	364604	146	375026	149	383036	153	410015	121
363015	145	360173	157	366001	159	375027	149	383038	153	410016	121
363015L	144	3607NV07	368	366002	158	375028	149	383041	153	410017	121
363016	145	3607NV08	368	37006FB	95	375030	149	383046	153	410018	121
363016L	144	3607NV09	368	37006FN	95	375032	149	383050	153		
		3607NV10	368	37036FB	95	375033	149				

4

Indice numerico

Numeric index

Codice Code	Pag.	Codice Code	Pag.	Codice Code	Pag.	Codice Code	Pag.	Codice Code	Pag.	Codice Code	Pag.
410019	121	415025	104	431016	123	444001	124	506004	163	53048FB	95
410020	121	415026	104	431017	123	444002	124	506004PK	163	53048FN	95
410021	121	415027	104	431018	123	445006	125	506004PKC	163	550001	176
410022	121	415028	104	431201	122	445007	125	506005	163	550002	176
410024	121	415029	104	431301	122	445008	125	506005PK	163	550003	176
410701	121	415030	104	435001	123	445009	125	507001	166	550004	176
411701	121	415031	104	435002	123	445010	125	507001A	168	550005	176
414001	104	415032	104	435003	123	445011	125	507002	166	550501	176
414002	104	415033	104	435004	123	445012	125	507002B	168	550502	176
414003	104	415034	104	435005	123	445013	125	507003	167	550503	176
414004	104	415035	104	435006	123	445014	125	507003L	168	550504	176
414005	104	415036	104	435007	123	445015	125	507003R	168	550505	176
414006	104	415037	104	435008	123	445016	125	507004	167	560001	165
414007	104	415301	105	435009	123	445017	125	507004L	168	560003	190
414008	104	415302	105	435010	123	445018	125	507203	184	560004	191
414009	104	415303	105	435011	123	445019	125	507501	167	560004C	191
414010	104	415304	105	435012	123	445020	125	507601	166	560005	192
414011	104	415305	105	435013	123	445021	125	507701	167	560010	176
414012	104	415306	105	435101	123	445022	125	507702	167	560014	192
414013	104	415307	105	435301	123	445023	125	507702I	167	560015	192
414014	104	415308	105	435303	124	445024	125	507801	168	560016	192
414015	104	415309	105	441006	124	445025	125	507801-I	168	560017	192
414016	104	415310	105	441007	124	445026	125	507801I	168	560018	192
414017	104	415311	105	441008	124	445027	125	508007M	177	560020	192
414018	104	415312	105	441009	124	445028	125	508009M	177	560023	190
414019	104	415313	105	441010	124	445030	125	508011M	177	560109	264
414020	104	416001	109	441011	124	445032	125	508125	171	560110	264
414021	104	416002	109	441012	124	445101	125	508126	171	560136	264
414022	104	416003	109	441013	124	445201	125	508127	171	560137	264
414023	104	416004	109	441014	124	45076FB	95	508130	170	561001	266
414024	104	416005	109	441015	124	45076FN	95	508130P	170	561002	266
414025	104	416006	109	441016	124	470000	358	508131	171	561138	265
414026	104	416007	109	441017	124	47CO150	358	508132	172	561139	265
414027	104	416008	109	441018	124	47CO210	358	508132P	172	561140	265
414028	104	416009	109	441019	124	47CPN12	359	508132PC	172	561141	265
414029	104	416010	109	441020	124			508134	172	561142	265
414030	104	416011	109	441021	124			508201	187	562120	265
414031	104	416012	109	441022	124			508201P	188	562121	265
414032	104	416013	109	441203	110			508202	187	562122	265
414033	104	425001	128	441204	110	500001	161	508202P	188	562141	265
414034	104	425201	128	441205	110	500003	161	508203	187	562142	265
414035	104	430001	122	441206	110	500004	161	508203P	188	570020	184
414036	104	430002	122	441207	110	500005	161	508204	187	570020R	184
414037	104	430003	122	441208	110	500051	162	508204P	188	570021	184
414038	104	430004	122	441209	110	500052	162	508205	187	570021R	184
414039	104	430005	122	441210	110	500053	162	508205P	188	570022	163
414040	104	430006	122	441211	110	500054	162	508206P	188	570025V	185
414042	104	430007	122	441212	110	500055	162	508301	187	570026	178
415001	104	430008	122	441213	110	501001	161	508302P	187	570026M	178
415002	104	430009	122	441214	110	501002	161	508400P	188	570027	179
415003	104	430010	122	441403	110	501003	161	508401	187	570027R	179
415004	104	430011	122	441404	110	501004	161	508401P	188	570028	179
415005	104	430012	122	441405	110	501005	161	508402	187	570029	179
415006	104	430013	122	441406	110	504001	162	508402P	188	570030	136
415007	104	43048FB	95	441407	110	504002	162	508403	187	570031	186
415008	104	43048FN	95	441408	110	504003	162	508403P	188	570032P	177
415009	104	430801	122	441409	110	504004	162	508404	187	570033	192
415010	104	431001	123	441410	110	504005	162	508404P	188	570033E	192
415011	104	431002	123	441411	110	504006	162	508405P	188	570034P	180
415012	104	431003	123	441412	110	504007	162	508406P	188	570035	185
415013	104	431004	123	441413	110	505001	162	508407P	188	570035D	185
415014	104	431005	123	441414	110	505002	162	508408P	188	570036	173
415015	104	431006	123	441501	111	505003	162	508409P	188	570037P	180
415016	104	431007	123	441502	111	505004	162	508410P	188	570040	178
415017	104	431008	123	441503	111	506001	163	508411P	188	570042	189
415018	104	431009	123	441504	111	506001PK	163	510001	128	570044	170
415019	104	431010	123	441505	111	506001PKC	163	510002	128	570045	170
415020	104	431011	123	441601	111	506002	163	510003	128	570048	171
415021	104	431012	123	441602	111	506002PK	163	510004	128	570050	175
415022	104	431013	123	441603	111	506002PKC	163	510005	128	570055	178
415023	104	431014	123	441604	111	506003	163	510006	128	570057-1	173
415024	104	431015	123	441605	111	506003PK	163	510007	128	570057-2	173

5

Indice numerico

Numeric index

Codice Code	Pag.	Codice Code	Pag.	Codice Code	Pag.	Codice Code	Pag.	Codice Code	Pag.	Codice Code	Pag.
570061	189	603012P	244	610013P	279	610082	285	623002	222	660055A	344
570062	173	603030	245	610014	275	610201	181	623003	221	660057	336
570063	192	603050	245	610014P	279	610202	182	623004	222	660064	344
57076FB	95	603050P	244	610014T	273	610202C	182	623005	220	660065	344
57076FN	95	603060P	244	610015	275	610203	183	623006	221	660066	344
577580	191	603080	245	610016	275	610204	183	623007	220	660067	357
577581	191	603080P	244	610017	275	610204C	183	623008	221	660068	355
577582	191	603100P	244	610018	275	610205	183	623009	219	660069	357
		603104	246	610019	276	610301	181	623010	220	660070	354
6		603104P	244	610019P	279	610301L	181	625001	96	660071	354
600000	335	603105	246	610020	276	610302	181	625002	96	660072	354
600001	238	603105P	244	610020P	279	610302L	181	625003	96	660073	359
600001E	238	603106	246	610021	276	610401	181	625004	96	660074	355
600002	238	603106P	244	610022	276	610401M	181	625005	96	660075	359
600002E	238	603108	246	610023	280	610501	182	625006	96	660076	359
600002P	238	603108P	244	610025	281	610502	182	630019	266	660077	359
600002PE	238	603110	246	610026	281	610701	182	630020	266	660078	359
600005	214	603110P	244	610027	273	610805	184	630021	266	660079	360
600005A	214	603112P	244	610028	277	610816	184	630022	266	660080	360
600006	213	603204	246	610029	277	610820	184	630065	217	660081	360
600007	213	603204P	244	610030	277	610825	184	630080	216	660082	360
600007M	213	603205	246	610031	277	610832	184	630081	217	660083	360
600009	215	603205P	244	610032	277	610840	184	630082	217	660084	360
600009E	215	603206	246	610033	277	610850	184	660001	335	660085	360
600009G	215	603206P	245	610034	277	610863	184	660001M	335	660086	360
600009GR	215	603208	246	610035	280	610901	183	660002	336	660087	360
600009R	215	603208P	245	610036	280	610902	183	660002M	337	660088	360
6000153	83	603210	246	610037	280	611001	94	660002SM	337	660089	360
600036	339	603210P	245	610038	280	612002	94	660003	337	670002M	341
600038	339	603212P	245	610039	280	612003	94	660003M	337	670003	341
600039	339	603310P	245	610040	278	612006	94	660004	336	670004	341
601004E	242	604001	212	610041	278	612008	94	660004M	336	670013M	342
601006	239	604002	212	610042	278	614001	94	660007	330	670014M	342
601007	239	604005	212	610043	278	614002	94	660007M	330	670017	322
601008	239	605001	96	610044	278	614003	94	660011	328	670018	342
601009	239	605002	96	610045	280	614008	96	660012	351	670026	331
601011	241	609000D	358	610046	280	614009	96	660012B	351	670026SM	331
601106	239	609001P	218	610047	280	614010	96	660014	338	670027	331
601108	239	609002	216	610048	282	614011	96	660015	211	670029	330
601109	239	609002P	218	610049	282	614012	96	660015M	211	670029M	330
601406	239	609002E	218	610050	282	614013	96	660016	320	670030	328
601407	239	609003P	218	610051	282	614014	96	660017	322	670032	175
601408	239	609004	217	610052	282	614108	96	660018	320	670033	332
601409	239	609004/9	217	610053	282	614111	96	660029	212	670035	328
601410	239	609004E	218	610054	282	615203	93	660031	327	670039	331
601502	240	609004F2V	216	610055	282	615204	93	660032	350	670040	328
601503	240	609004F3V	216	610056	282	615206	93	660032L	361	670040M	341
601504	240	609004P	218	610057	282	62000E	271	660033	350	670047	340
601505	240	609005E	218	610058	282	620005	271	660033F	361	670047M	340
601505	240	609005P	218	610059	282	620005F	274	660033FA	361	670048	340
601506	240	609008E	218	610060	283	620006	271	660033LM	361	670048M	340
601507	240	609009	358	610061	283	620006/250	271	660033SE	361	670049B	340
601508	240	609009E	218	610062	283	620006/400	271	660034	336	670049M	340
601509	240	61000E	273	610063	283	620006C	272	660035	338	670050	340
601510	240	610001	94	610064	283	620006CC	272	660035M	338	670050M	340
602001	241	610006	273	610065	283	620006F	274	660037	351	670053	357
602002	241	610006/400	273	610066	283	620006L	277	660040	355	670055	211
602003	241	610006F	274	610067	283	620008	271	660040E	356	670056	211
602004	241	610008	273	610068	283	620008C	272	660041	355	670057	338
602005	241	610008F	274	610069	283	620008CC	272	660041E	356	670057M	344
602006	241	610009	275	610070	283	620008F	274	660042	356	670057MP	338
602007	241	610009P	278	610071	284	620008L	277	660042E	356	670058	201
602101	242	610010	275	610072	284	620008LL	277	660043	357	670058MP	201
602102	241	610010P	278	610073	284	620010	271	660044	357	670060	323
602103	242	610010T	273	610074	284	620010F	274	660045	332	670061	323
603000	246	610010TF	274	610075	285	620010L	277	660047	332	670062	332
603000P	244	610011	275	610076	285	620010LL	277	660050	343	670063	201
603001	245	610011P	279	610077	284	620012	271	660051	336	670064	201
603002	245	610012	275	610078	284	620014	271	660052	343	670065	201
603002P	244	610012P	279	610079	284	620015	278	660053	343	670066	321
603003	246	610012T	273	610080	284	620016	278	660054	343	670067	323
603010P	244	610013	275	610081	285	623001	222	660055	343	670069	201

Indice numerico

Numeric index

Codice Code	Pag.	Codice Code	Pag.	Codice Code	Pag.
670070	321	875073	237	886001PB	300
670070M	344	875074	237	886001T	300
670071	323	875080	236	886101	302
670072	323	875080E	236	886101B	302
670092	332	875081	236	886101C	302
671030	328	875081E	236	886101D	302
671035	328	875082	236	886101DF	302
671040	328	875082E	236	886101DP	302
7		875083	236	886101E	302
700000	304	875083E	236	886101F	302
700002	304	875084	236	886101G	302
700003	304	875084E	236	886101H	302
75076FB	95	875085E	236	886101I	302
75076FN	95	875086E	236	886101PB	302
		875107F	213	886101PC	302
		875107R	213	886101T	302
		875108F	213	886501	301
		875108R	213	886501DF	301
		875109F	213	886501DP	301
		875109R	213	886501PC	301
860606V	369	875380	236	886501PB	301
860608V	369	875380E	237	886501T	301
860609V	369	875381	236	890501	385
860610G	369	875381E	237	890502	384
863206	370	875382	236	890503	384
863207	370	875382E	237	890504	384
863208	370	875383	236	890505	385
863208M	369	875383E	237	890506	384
863209M	369	875384	236	890507	385
863210M	369	875384E	237		
863408	370	875385E	237	9	
863408V	370	875386E	237	910101	305
863610V	369	875470	237	910102	303
870611	372	875471	237	910103	303
870612	372	875472	237	910104	303
870613	372	875473	237	910105	305
870614	372	875501	214	991	65
870711	370	875502	214	992	65
870712	370	875505	214	993	65
870713	370	875506	214	994	66
870714	370	875530	238	995	66
870101	296	875531	238	996	66
870301	296	875532	238		
870501	296	875533	238		
870501P	296	875570	237		
870701	296	875571	237		
870702	296	875572	237		
870703	296	876001	128		
870704	297	876002	303		
870704C	297	876100	130		
870704G	297	876101	130		
870704P	297	876102	130		
870704PE	297	876103	130		
870801	296	876104	130		
875008	236	876105	130		
875010	266	876106	130		
875011	267	876111	130		
875012	128	876201	130		
875013	128	876202	130		
875030F	213	876203	130		
875030R	213	876204	130		
875031F	213	876205	130		
875031R	213	880601P	303		
875032F	213	880601G	303		
875032R	213	880801	303		
875050	235	880901	303		
875051	235	881101	299		
875052	235	881105	299		
875053	235	881106	299		
875054	235	886001	300		
875070	237	886001DF	300		
875071	237	886001PC	300		
875072	237				

CONDIZIONI DI VENDITA

Le ordinazioni sono assunte alle condizioni qui sotto specificate che si intendono accettate dal committente. Eventuali deroghe sono accettate solo in seguito ai reciproci accordi e dovranno risultare per iscritto.

ORDINI: Con il conferimento dell'ordine si intendono approvate dal committente tutte le condizioni di vendita GIMAP in vigore, gli ordini sono irrevocabili da parte del committente ma potranno non essere evasi a ns. insindacabile giudizio e senza obbligo di comunicazione.

Nell'ordine è necessario specificare il numero di articolo e l'eventuale misura che lo contraddistingue; omettendo di indicare prezzi, sconto e condizioni di pagamento se ne facilita la gestione; specificare solo: "condizioni in vigore".

Comunque gli ordini mancanti dei dati necessari alla loro evasione verranno completati, ridotti o rifiutati dalla GIMAP a suo giudizio e senza alcuna possibilità di rivalsa da parte del committente.

CONFEZIONE E IMBALLO: I quantitativi per ogni articolo e misura, devono essere ordinati attenendosi alle confezioni standard GIMAP. Le spese di imballo, salvo il caso delle "piccole spedizioni", sono comprese nel prezzo.

TERMINI DI CONSEGNA: I termini di consegna sono approssimativi e vengono computati per giorni lavorativi.

L'evasione dell'ordine è subordinato alla disponibilità del magazzino e alla possibilità di fabbricazione, non dando quindi garanzia di saldo. Ci si riserva pertanto di evadere l'ordine in diverse riprese. Eventuali ritardi non costituiscono titolo di rivalsa per danni né diritto di annullamento o riduzione dell'ordine.

Non si risponde inoltre di ritardi o riduzioni delle forniture cagionate da cause di forza maggiore, quali interruzioni di lavoro, calamità o altro.

SPEDIZIONI: Le spedizioni sono effettuate in porto franco con mezzi di trasporto di ns. scelta: la merce viaggia comunque a rischio e pericolo del committente. Prima di accettare in consegna la merce, si raccomanda di controllare il peso e lo stato: in caso di ritardo, avaria o perdita, il committente potrà e dovrà rivalersi direttamente con il vettore non assumendo la GIMAP alcuna responsabilità a riguardo.

RIMANENZE: Nel caso di evasione incompleta di ordini la rimanenza verrà, se disponibile, inclusa anche parzialmente nella spedizione successiva e comunque entro 60 giorni sulla prima evasione.

Verranno annullati automaticamente i residui ordini inferiori a euro 80,00 + IVA.

PICCOLE SPEDIZIONI - PORTO FRANCO: Nel caso di ordini e/o spedizioni di piccolo importo, sarà addebitata, a titolo di contributo, una quota fissa valore della fattura netta, pari a: euro 13,50 (nord), 16,50 (centro), 20,00 (sud Italia e isole) Spedizione in porto franco per ordini e/o spedizioni superiori a euro 500,00 + IVA e relativi saldi.

RI TIRO PRESSO NS. STABILIMENTI: Qualora il committente ritiri la merce presso i ns. stabilimenti dovrà tenere presente che ciò è possibile solo negli orari di magazzino, con preavviso di almeno 48 ore e solo per merce già ordinata. Non sarà comunque accreditato alcun rimborso per quanto concerne spese di trasporto.

GARANZIA: Tutti gli utensili sono garantiti per le qualità dei materiali e della fabbricazione. Si sostituisce o si ripara quindi gratuitamente il pezzo riscontrato difettoso all'origine e solo se reso f.co Premana (Lecco) con relativa bolla di accompagnamento sulla quale dovranno essere indicati, oltre alla dicitura "MERCE DIFETTOSA", gli estremi del documento assoggettato all'imposta, emesso all'atto della vendita. Sono esclusi da tale garanzia gli utensili che presentano normale usura, segni di manomissione o uso improprio, la garanzia esclude qualsiasi genere.

SOSTITUZIONE: Nel caso di sostituzione di merce perché non conforme all'ordinato, si devono fissare accordi preventivi per la eventuale sostituzione da effettuarsi in porto franco. La merce dovrà essere accompagnata da relativa bolla di accompagnamento con la dicitura "MERCE NON CONFORME ALL'ORDINATO". I relativi accrediti per rettifica di inesattezza sulla ns. fornitura saranno emessi esclusivamente a cura della GIMAP.

Ogni reso di merce per qualsiasi ragione dovrà essere preventivamente autorizzato dalla GIMAP. Eventuali resi non autorizzati saranno respinti al mittente.

PREZZI: I prezzi sono quelli validi al momento della spedizione della merce.

PAGAMENTI: I pagamenti deve essere fatto esclusivamente alla FUMASI ed alle condizioni stabilite. Non si ammettono arrotondamenti e trattenute. Sconti per pagamenti a ricevimento fattura vanno calcolati sull'importo netto della merce, escluso imballo, spese postali o di trasporto ed IVA. Trascorsi sui pagamenti ritardati si computano gli interessi bancari e le eventuali spese accessorie. Il mancato pagamento di parte dell'importo o un ritardo di pagamento superiore a 30 gg. dalla data indicata in fattura darà diritto alla risoluzione del contratto: potrà essere trattenuta la parte di prezzo pagata e si potrà pretendere la restituzione del materiale fornito, a cura e spese del committente, salvo il risarcimento del danno.

FORO COMPETENTE: Per qualsiasi controversia e per la risoluzione si riconosce l'esclusiva competenza al Foro Giudiziario di Lecco.

RECLAMI PRODOTTI NON CONFORMI ALL'ORDINATO: E' inteso che eventuali reclami o contestazioni non danno diritto al committente di sospendere o comunque ritardare i pagamenti dei prodotti oggetto di contestazione, né, tanto meno, di altre forniture.

Le foto hanno un valore puramente illustrativo e possono non rispecchiare l'immagine del prodotto.

SALES CONDITIONS

General sales conditions save as otherwise agreed between the Parties, the present General Sales Conditions together with the special conditions indicated in the order confirmation regulate all sales of products between GIMAP (Seller) and any Buyer, save any specific reciprocal trade agreements in terms of exceptions in a written form.

ORDERS: Placing an order the client accepts all Gimap's general commercial conditions, the orders are irrevocable as to the Buyer but the Seller may not execute the order upon its unquestionable decision without any notice. When placing order it's necessary to indicate the items numbers and its size; without adding prices, discounts or payment conditions, just specifying "Conditions in force". However the orders with incomplete information will be dispatched, reduced or declined by Gimap upon its unquestionable decision and without the Client having any right to make any kind of claim or demand.

PACKING AND WRAPPING: All the ordering quantities concerning every item and size should be ordered according to Gimap's standard, the packing in blister or hanging card must be applied a surdarge of 0,25€.

DELIVERY TERMS: Delivery terms are approximate and are calculated in working days. Orders dispatching depends on stock availability, producing possibility without any balance guarantee. We reserve the right to ispatch the orders on several occasions. Eventual late does not commit to accept cancellations or modifications of orders and doesn't give right to claim or demand. Same for late and reduces due to force major such as working interruptions, disasters or other.

SHIPPING: Delivery of the products is to be considered EX WORKS OUR WAREHOUSE, if the shipment is organized from GIMAP's forwarder, the amount will be charged on the invoice: anyway the Seller is not responsible for goods transportation. Before accepting goods shipping it's highly loss or incident the buyer may and should make good his losses directly at the carrier as Gimap is not responsible.

INCOMPLETE DELIVERY: In case of incomplete shipping, the remaining part, if available, will be included in the first further shipping, however within 60 days from the first shipping. The remaining parts under euro 80,00 will be automatically cancelled.

GOODS COLLECTION AT OUR FACTORIES: If the Buyer wish to collect goods at the factory it is necessary to realize that it is possible only during opening hours and upon 48 hours notice and only for already ordered goods. No shipping refund is provided.

WARRANTY: The Seller guarantees the materials and production quality. The faulty (defective) item will be free repaired or replaced if dispatched DDP Premana with packing list with following inscription "Faulty Item" together with documentation's sales details. The warranty will only cover material or production faults noticed during normal conditions of use of the Product. In no case whatsoever will the warranty be extended to de facts saused by insufficient maintenance or storage, incorrect use or any use different from the relative instructions.

REPLACEMENT: When the item should be replaced because it is not similar to the ordered one further agreement for eventual replacing should be fixed, considering DDP shipping. The item should be accompanied by the concerning packing list with following inscription "Not Similar Item". The eventual rectification and refund regarding to our mistake depends on Gimap's approval. Any given back goods for any reason should be authorized in advance by Gimap otherwise will be returned to sender.

PRICES: Consider valid the prices at the moment of goods shipping.

PAYMENTS: All payments should be made exclusively to FUMASI according to established conditions. Deductions or rounding off are not accepted. Payments invoice discounts are calculated at the net amount, excluding packing, postal or shipping fees. Payment should be made within the terms agreed. Delayed payments are due to bank interests and/or additional fees charging. If the Client delays a payment totally or partially for more than 30 days, the Seller may suspend any pending delivery, rescind the relative contract and withhold any amount paid in advance as compensation, until payment of the dam age agreed, without compromising the right to claim for further damages. Furthermore, the Seller may pretend the giving back of the supplied materials at Buyer's expense except for compensation of damages.

PLACE OF LAWFUL JURISDICTION: For any controversy that may arise between the Parties with regards to the General Conditions and their sale regulated by the same, the Tribunal of LECCO (Italy) will be considered competent.

COMPLAINTS REGARDING TO THE ITEMS NOT SIMILAR TO THE ORDER ONES:

It is understood that the eventual complaints and claims do not give a right to Buyer to suspend or to delay the payments of dispute items or other supplying. Indicated proces can undergo a change without any before hand notice. The photos are of just illustrative value and can not reflect the product's image.

The photos are purely illustrative and may not reflect the image of the product.

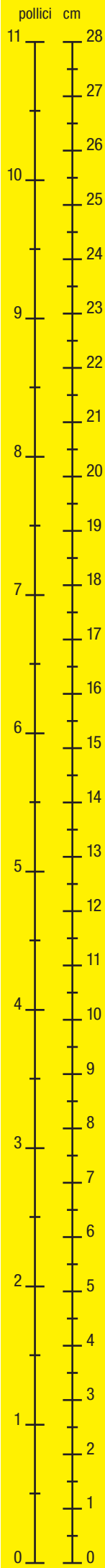



Gimap s.r.l.

SEDE LEGALE: Viale Vittorio Veneto, 32 - Milano 20124

SEDE OPERATIVA: Zona Industriale Giabbio - Premana (LC) 23834

Tel. : +39 0341/818000 - 818083

Fax: +39 0341 890765

info@fumasi.it www.fumasi.it